

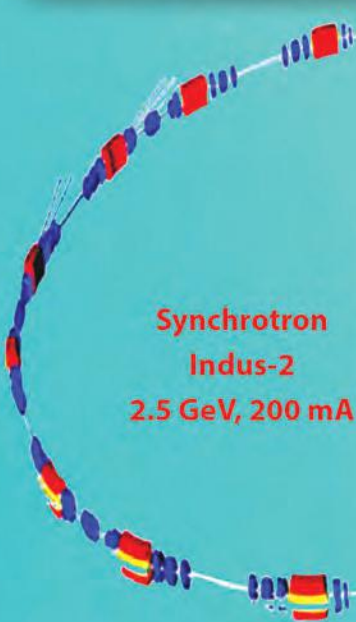

PHYSICS

Standard XII

Photoelectron spectroscopy beamline



The Coordination Committee formed by GR No. Abhyas - 2116/(Pra.Kra.43/16) SD - 4
Dated 25.4.2016 has given approval to prescribe this textbook in its meeting held on
30.01.2020 and it has been decided to implement it from academic year 2020-21

PHYSICS

Standard XII



Z7S7S4

Download DIKSHA App on your smartphone. If you scan the Q.R.Code on this page of your textbook, you will be able to access full text and the audio-visual study material relevant to each lesson, provided as teaching and learning aids.



2020

**Maharashtra State Bureau of Textbook Production and
Curriculum Research, Pune.**

First Edition :
2020

© **Maharashtra State Bureau of Textbook Production and Curriculum Research, Pune - 411 004.**

The Maharashtra State Bureau of Textbook Production and Curriculum Research reserves all rights relating to the book. No part of this book should be reproduced without the written permission of the Director, Maharashtra State Bureau of Textbook Production and Curriculum Research, 'Balbharati', Senapati Bapat Marg, Pune 411004.

Committee:

Dr. Chandrashekhar V. Murumkar, Chairman
Dr. Dilip Sadashiv Joag, Convener
Shri. Vinayak Shripad Katdare, Co- Convener
Dr. Pushpa Khare, Member
Dr. Rajendra Shankar Mahamuni, Member
Dr. Anjali Kshirsagar, Member
Dr. Rishi Baboo Sharma, Member
Shri. Ramesh Devidas Deshpande, Member
Shri. Rajiv Arun Patole, Member Secretary

Illustration

Shri. Shubham Chavan

Cover

Shri. Vivekanand S. Patil

Typesetting

DTP Section, Textbook Bureau, Pune

Co-ordination :

Shri. Rajiv Arun Patole
Special Officer - Science Section
Physics

Study group:

Dr. Umesh Anant Palnitkar
Dr. Vandana Laxmanrao Jadhav Patil
Dr. Neelam Sunil Shinde
Dr. Radhika Gautamkumar Deshmukh
Shri. Dinesh Madhusudan Joshi
Smt. Smitha Menon
Shri. Govind Diliprao Kulkarni
Smt. Pratibha Pradeep Pandit
Shri. Prashant Panditrao Kolase
Dr. Archana Balasaheb Bodade
Dr. Jayashri Kalyanrao Chavan
Smt. Mugdha Milind Taksale
Dr. Prabhakar Nagnath Kshirsagar
Shri. Ramchandra Sambhaji Shinde
Shri. Brajesh Pandey

Paper

70 GSM Creamwove

Print Order

Printer

Production

Shri Sachchitanand Aphale
Chief Production Officer
Shri Liladhar Atram
Production Officer

Publisher

Shri Vivek Uttam Gosavi
Controller
Maharashtra State Textbook
Bureau, Prabhadevi,
Mumbai - 400 025

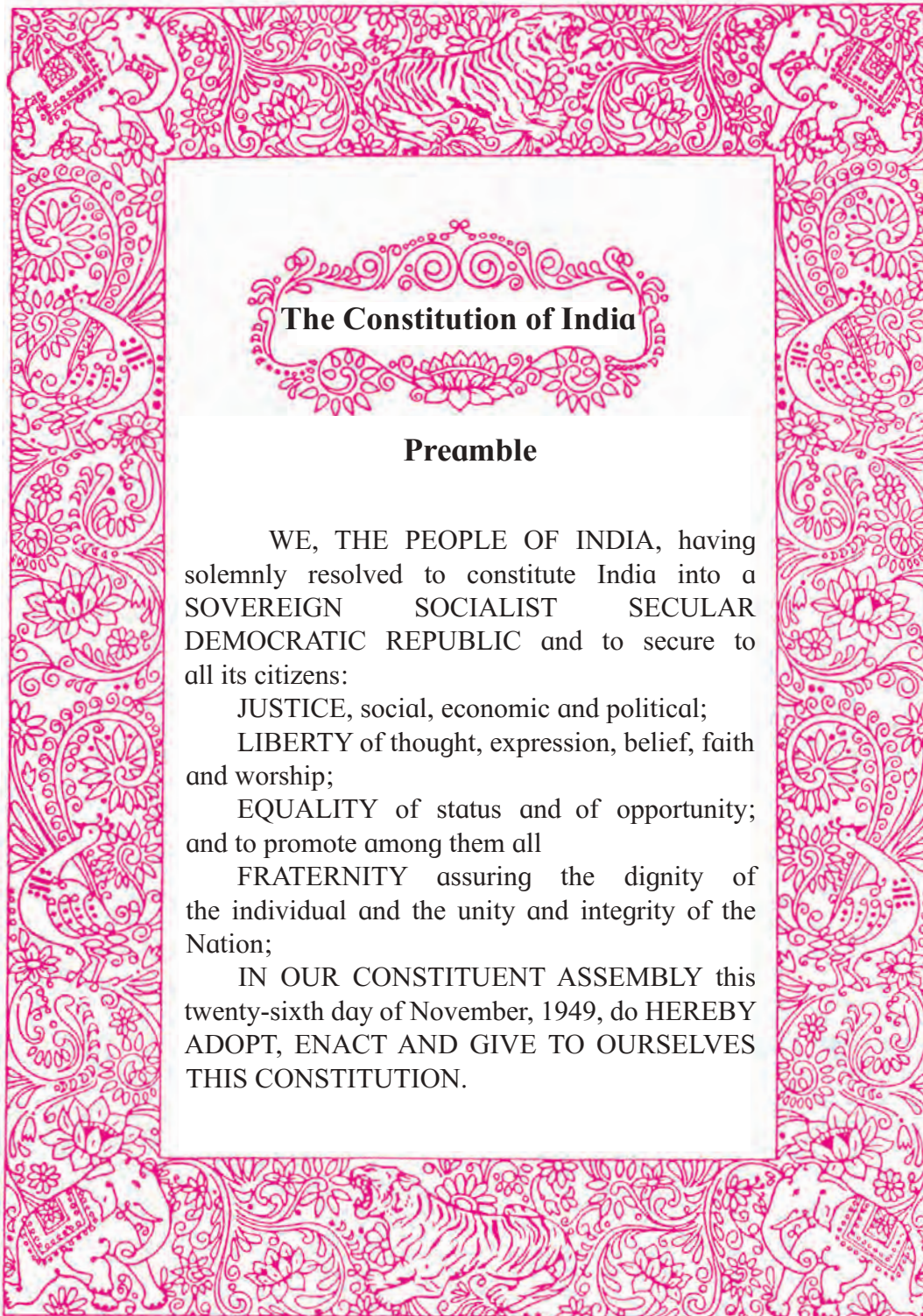

NATIONAL ANTHEM

Jana-gana-mana-adhināyaka jaya hē
Bhārata-bhāgya-vidhātā,

Panjāba-Sindhu-Gujarāta-Marāthā
Drāvida-Utkala-Banga

Vindhya-Himāchala-Yamunā-Gangā
uchchala-jaladhi-taranga

Tava subha nāmē jāgē, tava subha āsisa māgē,
gāhē tava jaya-gāthā,

Jana-gana-mangala-dāyaka jaya hē
Bhārata-bhāgya-vidhātā,

Jaya hē, Jaya hē, Jaya hē,
Jaya jaya jaya, jaya hē.

PLEDGE

India is my country. All Indians
are my brothers and sisters.

I love my country, and I am proud
of its rich and varied heritage. I shall
always strive to be worthy of it.

I shall give my parents, teachers
and all elders respect, and treat
everyone with courtesy.

To my country and my people,
I pledge my devotion. In their
well-being and prosperity alone lies
my happiness.

Preface

Dear Students,

With great pleasure we place this detailed text book on basic physics in the hands of the young generation. This is not only a textbook of physics for XIIth standard, but contains material that will be useful for the reader for self study.

This textbook aims to give the student a broad perspective to look into the physics aspect in various phenomena they experience. The National Curriculum Framework (NCR) was formulated in the year 2005, followed by the State Curriculum Framework (SCF) in 2010. Based on the given two frameworks, reconstruction of the curriculum and preparation of a revised syllabus has been undertaken which will be introduced from the academic year 2020-21. The textbook incorporating the revised syllabus has been prepared and designed by the Maharashtra State Bureau of Textbook Production and Curriculum Research, (Balbharati), Pune.

The objective of bringing out this book is to prepare students to observe and analyse various physical phenomena in the world around them and prepare a solid foundation for those who aspire for admission to professional courses through competitive examinations. Most of the chapters in this book assume background knowledge of the subject covered by the text book for XIth Standard, and care has been taken of mentioning this in the appropriate sections of the book. The book is not in the form of handy notes but embodies a good historical background and in depth discussion as well. A number of solved examples in every chapter and exercises at the end of each one of them are included with a view that students will acquire proficiency and also will get enlightened after solving the exercises. Physics is a highly conceptual subject. Problem solving will enable students understand the underlying concepts. For students who want more, boxes entitled 'Do you know?' have been included at a number of places.

If you read the book carefully and solve the exercises in each chapter, you will be well prepared to face the challenges of this competitive world and pave the way for a successful career ahead.

The efforts taken to prepare the textbook will prove to be worthwhile if you read the textbook and understand the subject. We hope it will be a wonderful learning experience for you and an illuminating text material for teachers too.



(Vivek Gosavi)
Director

Pune

Date : 21 February, 2020
Bhartiya Saur : 2 Phalgun, 1941

Maharashtra State Bureau of Textbook
Production and Curriculum Research, Pune

- For Teachers -

Dear Teachers,

We are happy to introduce the revised textbook of Physics for XIIth standard. This book is a sincere attempt to follow the maxims of teaching as well as develop a 'constructivist' approach to enhance the quality of learning. The demand for more activity based, experiential and innovative learning opportunities is the need of the hour. The present curriculum has been restructured so as to bridge the credibility gap that exists between what is taught and what students learn from direct experience in the outside world. Guidelines provided below will help to enrich the teaching-learning process and achieve the desired learning outcomes.

- ✓ To begin with, get familiar with the textbook yourself, and encourage the students to read each chapter carefully.
- ✓ The present book has been prepared for constructivist and activity-based teaching, including problem solving exercises.
- ✓ Use teaching aids as required for proper understanding of the subject.
- ✓ Do not finish the chapter in short. However, in the view of insufficient lectures, standard derivations may be left to the students for self study. Problem solving must be given due importance.
- ✓ Follow the order of the chapters strictly as listed in the contents because the units are

introduced in a graded manner to facilitate knowledge building.

- ✓ 'Error in measurements' is an important topic in physics. Please ask the students to use this in estimating errors in their measurements. This must become an integral part of laboratory practices.
- ✓ Major concepts of physics have a scientific base. Encourage group work, learning through each other's help, etc. Facilitate peer learning as much as possible by reorganizing the class structure frequently.
- ✓ Do not use the boxes titled 'Do you know?' or 'Use your brain power' for evaluation. However, teachers must ensure that students read this extra information and think about the questions posed.
- ✓ For evaluation, equal weightage should be assigned to all the topics. Use different combinations of questions. Stereotype questions should be avoided.
- ✓ Use Q.R. Code given in the textbook. Keep checking the Q.R. Code for updated information. Certain important links, websites have been given for references. Also a list of reference books is given. Teachers as well as the students can use these references for extra reading and in-depth understanding of the subject.

Best wishes for a wonderful teaching experience!

References:

1. Fundamentals of Physics - Halliday, Resnick, Walker; John Wiley (Sixth ed.).
2. Sears and Zeemansky's University Physics - Young and Freedman, Pearson Education (12th ed.)
3. Physics for Scientists and Engineers - Lawrence S. Lerner; Jones and Bartlett Publishers, UK.

Front Cover : Picture shows part of Indus 2, Synchrotron radiation source (electron accelerator) at RRCAT, Department of Atomic Energy, Govt. of India, Indore. Indus offers several research opportunities. The photoelectron spectroscopy beamline is also seen.

Picture credit : Director, RRCAT, Indore. The permission to reproduce these pictures by Director, RRCAT, DAE, Govt. of India is gratefully acknowledged.

Back Cover : Transmission Electron Microscope is based on De Broglie's hypothesis. TEM picture shows a carbon nanotube filled with water showing the meniscus formed due to surface tension. Other picture shows crystallites of LaB₆ and the electron diffraction pattern (spot pattern) of the crystallite. Picture credit : Dr. Dilip Joag, Savitribai Phule Pune University. Pune

DISCLAIMER Note : All attempts have been made to contact copy right/s (©) but we have not heard from them. We will be pleased to acknowledge the copy right holder (s) in our next edition if we learn from them.

Competency Statements :
Standard XII

Area/ Unit/ Lesson	Competency Statements After studying the content in Textbook students would be able to....
Unit I Rotational Motion and Mechanical Properties of fluids	<ul style="list-style-type: none"> • Distinguish between centrifugal and centripetal forces. • Visualize the concepts of moment of inertia of an object. • Relate moment of inertia of a body with its angular momentum. • Differentiate between translational and rotational motions of rolling objects. • Relate the pressure of a fluid to the depth below its surface. • Explain the measurement of atmospheric pressure by using a barometer. • Use Pascal's law to explain the working of a hydraulic lift and hydraulic brakes. • Relate the surface energy of a fluid with its surface tension. • Distinguish between fluids which show capillary rise and fall. • Identify processes in daily life where surface tension plays a major role. • Explain the role of viscosity in everyday life. • Differentiate between streamline flow and turbulent flow.
Unit II Kinetic theory and Thermodynamics	<ul style="list-style-type: none"> • Relate various gas laws to form ideal gas equation. • Distinguish between ideal gas and a real gas. • Visualise mean free path as a function of various parameters.. • Obtain degrees of freedom of a diatomic molecule. • Apply law of equipartition of energy to monatomic and diatomic molecules. • Compare emission of thermal radiation from a body with black body radiation. • Apply Stefan's law of radiation to hot bodies . • Identify thermodynamic process in every day life. • Relate mechanical work and thermodynamic work. • Differentiate between different types of thermodynamic processes. • Explain the working of heat engine, refrigerator and air conditioner.
Unit III Oscillations and waves	<ul style="list-style-type: none"> • Identify periodic motion and simple harmonic motion. • Obtain the laws of motion for simple pendulum. • Visualize damped oscillations. • Apply wave theory to understand the phenomena of reflection, refraction, interference and diffraction. • Visualize polarized and unpolarized light. • Apply concepts of diffraction to calculate the resolving power. • Distinguish between the stationary waves in pipes with open and closed ends. • Verify laws of vibrating string using a sonometer. • Explain the physics involved in musical instruments.
Unit IV Electrostatics and electric current	<ul style="list-style-type: none"> • Use Gaus's law to obtain the electric field for a charge distribution. • Relate potential energy to work done to establish a charge distribution. • Determine the electrostatic potential for a given charge distribution. • Distinguish between conductors and insulators. • Visualize polarization of dielectrics. • Categorize dielectrics based on molecular properties. • Know the effect of dielectric material used between the plates of a capacitor on its capacitance. • Apply Kirchoff's laws to determine the current in different branches of a circuit. • Find the value of an unknown resistance by using a meter bridge. • Find the emf and internal resistance of a cell using potentiometer. • Convert galvanometer into voltmeter and ammeter by using a suitable resistor.

Unit V Magnetism	<ul style="list-style-type: none"> Realize that Lorentz force law is the basis for defining unit of magnetic field. Visualize cyclotron motion of a charged particle in a magnetic field. Analyze and calculate magnetic force on a straight and arbitrarily shaped current carrying wires and a closed wire circuit. Apply the Biot-Savart law to calculate the magnetic field produced by various distributions of currents. Use Ampere’s law to get magnetic fields produced by a current distribution. Compare gravitational, magnetic and electrostatic potentials. Distinguish between paramagnetic, diamagnetic and ferromagnetic materials. Relate the concept of flux to experiments of Faraday and Henry. Relate Lenz’s law to the conservation of energy. Visualize the concept of eddy currents. Determine the mutual inductance of a given pair of coils. Apply laws of induction to explain the working of a generator. Establish a relation between the power dissipated by an AC current in a resistor and the value of the rms current. Visualize the concept of phases to represent AC current. Explain the passage of AC current through circuits having resistors, capacitors and inductors. Explain the concept of resonance in LCR circuits.
Unit VI Modern Physics	<ul style="list-style-type: none"> Establish validity of particle nature of light from experimental results. Determine the necessary wavelength range of radiation to obtain photocurrent from given metals. Visualize the dual nature of matter and dual nature of light. Apply the wave nature of electrons to illustrate how better resolution can be obtained with an electron microscope. Check the correctness of different atomic models by comparing results of various experiments. Identify the constituents of atomic nuclei. Differentiate between electromagnetic and atomic forces. Obtain the age of a radioactive sample from its activity. Judge the importance of nuclear power. Explain use of p-n junction diode as a rectifier. Find applications of special purpose diodes for every day use. Explain working of solar cell, LED and photodiode. Relate the p-n junction diode and special purpose diodes. Realize transistor as an important building block of electronic circuits, analyze situations in which transistor can be used.

CONTENTS	Sr. No	Title	Page No
	1	Rotational Dynamics	1-25
	2	Mechanical Properties of Fluids	26-55
	3	Kinetic Theory of Gases and Radiation	56-74
	4	Thermodynamics	75-108
	5	Oscillations	109-130
	6	Superposition of Waves	131-157
	7	Wave Optics	158-185
	8	Electrostatics	186-213
	9	Current Electricity	214-229
	10	Magnetic Fields due to Electric Current	230-250
	11	Magnetic Materials	251-264
	12	Electromagnetic induction	265-287
	13	AC Circuits	288-305
	14	Dual Nature of Radiation and Matter	306-323
	15	Structure of Atoms and Nuclei	324-343
16	Semiconductor Devices	344-364	

1. Rotational Dynamics



Can you recall?

1. What is circular motion?
2. What is the concept of centre of mass?
3. What are kinematical equations of motion?
4. Do you know real and pseudo forces, their origin and applications?

1.1 Introduction:

Circular motion is an essential part of our daily life. Every day we come across several revolving or rotating (rigid) objects. During revolution, the object (every particle in the object) undergoes circular motion about some point outside the object or about some other object, while during rotation the motion is about an axis of rotation passing through the object.

1.2 Characteristics of Circular Motion:

- 1) It is an accelerated motion: As the direction of velocity changes at every instant, it is an accelerated motion.
- 2) It is a periodic motion: During the motion, the particle repeats its path along the same trajectory. Thus, the motion is periodic.

1.2.1 Kinematics of Circular Motion:

As seen in XIth Std, in order to describe a circular motion, we use the quantities angular displacement $\vec{\theta}$, angular velocity $\vec{\omega} = \frac{d\vec{\theta}}{dt}$ and angular acceleration $\vec{\alpha} = \frac{d\vec{\omega}}{dt}$ which are analogous to displacement \vec{s} , velocity $\vec{v} = \frac{d\vec{s}}{dt}$ and acceleration $\vec{a} = \frac{d\vec{v}}{dt}$ used in translational motion.

Also, the tangential velocity is given by $\vec{v} = \vec{\omega} \times \vec{r}$ where $\vec{\omega}$ is the angular velocity.

Here, the position vector \vec{r} is the radius vector from the centre of the circular motion. The magnitude of \vec{v} is $v = \omega r$.

Direction of $\vec{\omega}$ is always along the axis of rotation and is given by the right-hand thumb rule. To know the direction of $\vec{\omega}$, curl the fingers

of the right hand along the sense of rotation, with the thumb outstretched. The outstretched thumb then gives the direction of $\vec{\omega}$.

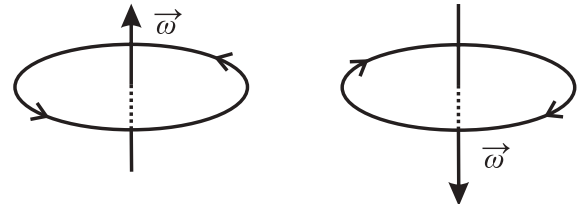

Fig. 1.1: Directions of angular velocity.

If T is period of circular motion or periodic time and n is the frequency, $\omega = 2\pi n = \frac{2\pi}{T}$

Uniform circular motion: During circular motion if the speed of the particle remains constant, it is called Uniform Circular Motion (UCM). In this case, only the direction of its velocity changes at every instant in such a way that the velocity is always tangential to the path. The acceleration responsible for this is the centripetal or radial acceleration $\vec{a}_r = -\omega^2 \vec{r}$. For UCM, its magnitude is constant and it is $a = \omega^2 r = \frac{v^2}{r} = v\omega$. It is always directed towards the centre of the circular motion (along $-\vec{r}$), hence called *centripetal*.

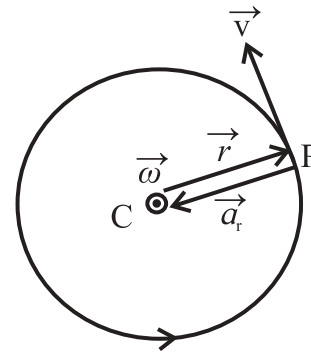

Fig. 1.2: Directions of linear velocity and acceleration.

Illustration: Circular motion of any particle of a fan rotating uniformly.

Non-uniform circular motion: When a fan is switched ON or OFF, the speeds of particles of the fan go on increasing or decreasing for some time, however their directions are always tangential to their circular trajectories.

During this time, it is a non-uniform circular motion. As the velocity is still tangential, the centripetal or radial acceleration \vec{a}_r is still there. However, for non-uniform circular motion, the magnitude of \vec{a}_r is *not* constant.

The acceleration responsible for changing the magnitude of velocity is directed along or opposite to the velocity, hence always tangential and is called as tangential acceleration \vec{a}_t .

As magnitude of tangential velocity \vec{v} is changing during a non-uniform circular motion, the corresponding angular velocity $\vec{\omega}$ is also changing at every instant. This is due to the angular acceleration $\vec{\alpha} = \frac{d\vec{\omega}}{dt}$

Though the motion is non-uniform, the particles are still in the same plane. Hence, the direction of $\vec{\alpha}$ is still along the axis of rotation. For increasing speed, it is along the direction of $\vec{\omega}$ while during decreasing speed, it is opposite to that of $\vec{\omega}$.

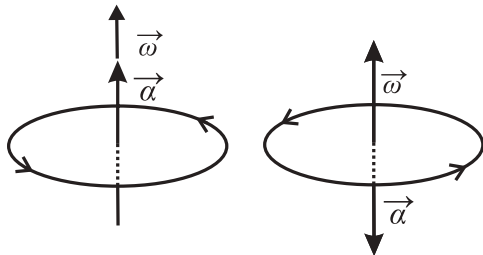
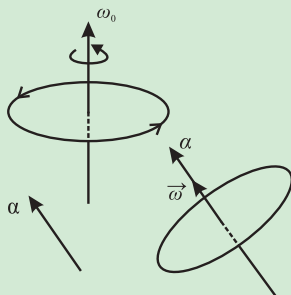

Fig. 1.3: Direction of angular acceleration.



Do you know?

If the angular acceleration $\vec{\alpha}$ is along any direction other than axial, it will have a component perpendicular to the axis. Thus, it will change the direction of $\vec{\omega}$ also, which will change the plane of rotation as $\vec{\omega}$ is always perpendicular to the plane of rotation.



If $\vec{\alpha}$ is constant in magnitude, but always perpendicular to $\vec{\omega}$, it will

always change only the direction of $\vec{\omega}$ and never its magnitude thereby continuously changing the plane of rotation. (This is similar to an acceleration \vec{a} perpendicular to velocity \vec{v} changing only its direction).

If the angular acceleration $\vec{\alpha}$ is **constant and along the axis of rotation**, all $\vec{\theta}$, $\vec{\omega}$ and $\vec{\alpha}$ will be directed along the axis. This makes it possible to use scalar notation and write the kinematical equations of motion analogous to those for translational motion as given in the table 1 at the end of the topic.

Example 1: A fan is rotating at 90 rpm. It is then switched OFF. It stops after 21 revolutions. Calculate the time taken by it to stop assuming that the frictional torque is constant.

Solution:

$$n_0 = 90 \text{ rpm} = 1.5 \text{ rps} \quad \therefore \omega_0 = 2\pi n_0 = 3\pi \frac{\text{rad}}{\text{s}}$$

The angle through which the blades of the fan move while stopping is $\theta = 2\pi N = 2\pi (21) = 42\pi \text{ rad}$, $\omega = 0$ (fan stops). Using equations analogous to kinematical equations of motion

$$\alpha = \frac{\omega - \omega_0}{t} = \frac{\omega^2 - \omega_0^2}{2\theta}$$

$$\therefore \frac{0 - 3\pi}{t} = \frac{0 - (3\pi)^2}{2(42\pi)} \quad \therefore t = 28 \text{ s}$$

Remark: One can also use the unit ‘revolution’ for angle and get rid of π throughout (for such data). In this case, $\omega_0 = 1.5 \text{ rps}$ and $\theta = 21 \text{ rev}$.

1.2.2 Dynamics of Circular Motion (Centripetal Force and Centrifugal Force):

i) Centripetal force (CPF): As seen above, the acceleration responsible for circular motion is the centripetal or radial acceleration $\vec{a}_r = -\omega^2 \vec{r}$. The force providing this acceleration is the centripetal or radial force, $\text{CPF} = -m\omega^2 \vec{r}$

**Remember this**

- (i) The word *centripetal* is NOT the name or type of that force (like *gravitational force*, *nuclear force*, etc). It is the adjective or property of that force saying that the direction of this force is along the radius and towards centre (centre seeking).
- (ii) While performing circular or rotational motion, the resultant of all the *real* forces acting upon the body is (or, must be) towards the centre, *hence* we call this *resultant* force to be centripetal force. Under the action of this *resultant* force, the direction of the velocity is always maintained tangential to the circular track.

The vice versa need not be true, i.e., the resultant force directed towards the centre may not always result into a circular motion. (In the Chapter 7 you will know that during an s.h.m. also the force is always directed to the centre of the motion). For a motion to be circular, correspondingly matching tangential velocity is also essential.

- (iii) Obviously, this discussion is in an inertial frame of reference in which we are *observing* that the body is performing a circular motion.
- (iv) In magnitude, centripetal force

$$= mr\omega^2 = \frac{mv^2}{r} = mv\omega$$

ii) Centrifugal force (c.f.f.):

Visualize yourself on a merry-go-round rotating uniformly. If you close your eyes, you will not know that you are performing a circular motion but you will feel that you are at rest. In order to explain that you are at rest, you need to consider a force equal in magnitude to the resultant real force, but directed opposite, i.e., away from the centre. This force, $(+m\omega^2\vec{r})$ is the centrifugal (away from the centre) force. It is a pseudo force arising due to the centripetal acceleration of the frame of reference.

It must be understood that centrifugal force is a non-real force, but NOT an imaginary force. Remember, before the merry-go-round reaches its uniform speed, you were *really* experiencing an outward pull (because, centrifugal force is greater than the resultant force towards the centre). A force measuring instrument can record it as well.

On reaching the uniform speed, in the frame of reference of merry-go-round, this centrifugal force exactly balances the resultant of all the *real* forces. The resultant force in that frame of reference is thus zero. Thus, only in such a frame of reference we can say that the centrifugal force balances the centripetal force. It must be remembered that in this case, centrifugal force means the '*net pseudo force*' and centripetal force means the '*resultant of all the real forces*'.

There are two ways of writing force equation for a circular motion:

$$\text{Resultant force} = -m\omega^2\vec{r} \quad \text{or}$$

$$m\omega^2\vec{r} + \sum(\text{real forces}) = 0$$

**Activity**

Attach a suitable mass to spring balance so that it stretches by about half its capacity. Now whirl the spring balance so that the mass performs a horizontal motion. You will notice that the balance now reads more mass for the same mass. Can you explain this?

1.3 Applications of Uniform Circular Motion:**1.3.1 Vehicle Along a Horizontal Circular Track:**

Figure 1.4 shows vertical section of a car on a horizontal circular track of radius r . Plane of figure is a vertical plane, perpendicular to the track but includes only centre C of the track. Forces acting on the car (considered to be a particle) are (i) weight mg , vertically downwards, (ii) normal reaction N , vertically upwards that balances the weight mg and (iii)

force of static friction f_s between road and the tyres. This is static friction because it prevents the vehicle from outward slipping or skidding. This is the resultant force which is centripetal.

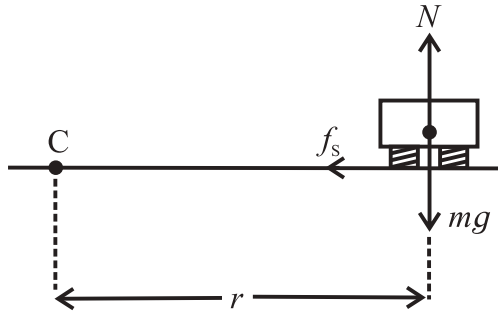

Fig. 1.4: Vehicle on a horizontal road.

While working in the frame of reference attached to the vehicle, it balances the centrifugal force.

$$\therefore mg = N \text{ and } f_s = mr\omega^2 = \frac{mv^2}{r}$$

$$\therefore \frac{f_s}{N} = \frac{r\omega^2}{g} = \frac{v^2}{rg}$$

For a given track, radius r is constant. For given vehicle, $mg = N$ is constant. Thus, as the speed v increases, the force of static friction f_s also increases. However, f_s has an upper limit $(f_s)_{max} = \mu_s \cdot N$, where μ_s is the coefficient of static friction between road and tyres of the vehicle. This imposes an upper limit to the speed v .

At the maximum possible speed v_s , we can write

$$\frac{(f_s)_{max}}{N} = \mu_s = \frac{v_{max}^2}{rg} \therefore v_{max} = \sqrt{\mu_s rg}$$



Do you know?

- (i) In the discussion till now, we had assumed the vehicle to be a point. In reality, if it is a four wheeler, the resultant normal reaction is due to all the four tyres. Normal reactions at all the four tyres are never equal while undergoing circular motion. Also, the centrifugal force acts through the centre of mass, which is not at the ground level,

but above it. Thus, the frictional force and the centrifugal force result into a torque which may topple the vehicle (even a two wheeler).

- (ii) For a two wheeler, it is a must for the rider to incline with respect to the vertical to prevent toppling.



Use your brain power

- (I) Obtain the condition for not toppling for a four-wheeler. On what factors does it depend, and in what way? Think about the normal reactions – where are those and how much are those! What is the recommendation on loading the vehicle for not toppling easily? If a vehicle topples while turning, which wheels leave the contact? Why? How does it affect the tyres? What is the recommendation for this?

- (II) Determine the angle to be made with the vertical by a two wheeler rider while turning on a horizontal track.

Hint: For both (I) and (II) above, find the torque that balances the torque due to centrifugal force and torque due to static friction force.

- (III) We have mentioned about static friction between road and the tyres. Why is it static? What about the kinetic friction between road and the tyres?

- (IV) What do you do if your vehicle is trapped on a slippery or a sandy road? What is the physics involved?

1.3.2 Well (or Wall) of Death: (मौत का कुआँ):

This is a vertical cylindrical wall of radius r inside which a vehicle is driven in horizontal circles. This can be seen while performing stunts.

As shown in the Fig. 1.5, the forces acting on the vehicle (assumed to be a point) are (i) Normal reaction N acting horizontally and

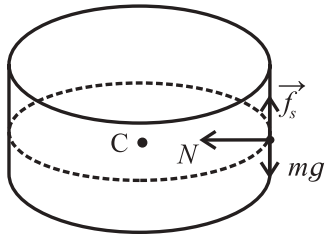

Fig. 1.5: Well of death.

towards the centre, (ii) Weight mg acting vertically downwards, and (iii) Force of static friction f_s acting vertically upwards between vertical wall and the tyres. It is static friction because it has to prevent the downward slipping. Its magnitude is equal to mg , as this is the only upward force.

Normal reaction N is thus the resultant centripetal force (or the only force that can balance the centrifugal force). Thus, in magnitude,

$$N = mr\omega^2 = \frac{mv^2}{r} \text{ and } mg = f_s$$

Force of static friction f_s is always less than or equal to $\mu_s N$.

$$\therefore f_s \leq \mu_s N \therefore mg \leq \mu_s \left(\frac{mv^2}{r} \right)$$

$$\therefore g \leq \frac{\mu_s v^2}{r} \therefore v^2 \geq \frac{rg}{\mu_s}$$

$$\therefore v_{\min} = \sqrt{\frac{rg}{\mu_s}}$$



Remember this

- N should always be equal to $\frac{mv^2}{r}$

$$\therefore N_{\min} = \frac{mv_{\min}^2}{r} = \frac{mg}{\mu_s}$$
- In this case, $f_s = \mu_s N$ is valid only for the minimum speed as f_s should always be equal to mg .
- During the derivation, the vehicle is assumed to be a particle. In reality, it is not so. During revolutions in such a well, a two-wheeler rider is *never* horizontal, else, the torque due to her/his weight will topple her/him. Think of the torque that balances the torque

due to the weight. What about a four-wheeler?

- In this case, the angle made by the road surface with the horizontal is 90° , i.e., if the road is banked at 90° , it imposes a lower limit on the turning speed. In the previous sub-section we saw that for an unbanked (banking angle 0) road there is an upper limit for the turning speed. *It means that for any other banking angle ($0 < \theta < 90^\circ$), the turning speed will have the upper as well as the lower limit.*

Example 2: A motor cyclist (to be treated as a point mass) is to undertake horizontal circles inside the cylindrical wall of a well of inner radius 4 m. Coefficient of static friction between the tyres and the wall is 0.4. Calculate the minimum speed and frequency necessary to perform this stunt. (Use $g = 10 \text{ m/s}^2$)

Solution:

$$v_{\min} = \sqrt{\frac{rg}{\mu_s}} = \sqrt{\frac{4 \times 10}{0.4}} = 10 \text{ m s}^{-1} \text{ and}$$

$$n_{\min} = \frac{v_{\min}}{2\pi r} = \frac{10}{2 \times \pi \times 4} \cong 0.4 \text{ rev s}^{-1}$$

1.3.3 Vehicle on a Banked Road:

As seen earlier, while taking a turn on a horizontal road, the force of static friction between the tyres of the vehicle and the road provides the necessary centripetal force (or balances the centrifugal force). However, the frictional force is having an upper limit. Also, its value is usually not constant as the road surface is not uniform. Thus, in real life, we should not depend upon it, as far as possible. For this purpose, the surfaces of curved roads are tilted with the horizontal with some angle θ . This is called banking of a road or the road is said to be banked.

Figure 1.6 Shows the vertical section of a vehicle on a curved road of radius r banked

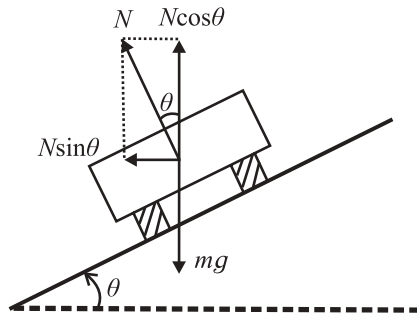

Fig 1.6: Vehicle on a banked road.

at an angle θ with the horizontal. Considering the vehicle to be a point and ignoring friction (not eliminating) and other non-conservative forces like air resistance, there are two forces acting on the vehicle, (i) weight mg , vertically downwards and (ii) normal reaction N , perpendicular to the surface of the road. As the motion of the vehicle is along a horizontal circle, the resultant force must be horizontal and directed towards the centre of the track. It means, the vertical force mg must be balanced. Thus, we have to resolve the normal reaction N along the vertical and along the horizontal. Its vertical component $N \cos \theta$ balances weight mg . Horizontal component $N \sin \theta$ being the resultant force, must be the necessary centripetal force (or balance the centrifugal force). Thus, in magnitude,

$$N \cos \theta = mg \quad \text{and}$$

$$N \sin \theta = mr\omega^2 = \frac{mv^2}{r} \therefore \tan \theta = \frac{v^2}{rg} \quad \text{--- (1.1)}$$

(a) Most safe speed: For a particular road, r and θ are fixed. Thus, this expression gives us the expression for the *most safe* speed (not a minimum or a maximum speed) on this road as $v_s = \sqrt{rg \tan \theta}$

(b) Banking angle: While designing a road, this expression helps us in knowing the angle of banking as

$$\theta = \tan^{-1} \left(\frac{v^2}{rg} \right) \quad \text{--- (1.2)}$$

(c) Speed limits: Figure 1.7 and 1.8 show vertical section of a vehicle on a *rough* curved road of radius r , banked at an angle θ . If the vehicle is running exactly at the speed $v_s = \sqrt{rg \tan \theta}$, the forces acting on the vehicle



Use your brain power

As a civil engineer, you are given contract to construct a curved road in a ghat. In order to obtain the banking angle θ , you need to decide the speed limit. How will you decide the values of speed v and radius r ?

are (i) weight mg acting vertically downwards and (ii) normal reaction N acting perpendicular to the road. As seen above, only at this speed, the resultant of these two forces (which is $N \sin \theta$) is the necessary centripetal force (or balances the centrifugal force). In practice, vehicles never travel exactly with this speed. For speeds other than this, the component of force of static friction between road and the tyres helps us, up to a certain limit.

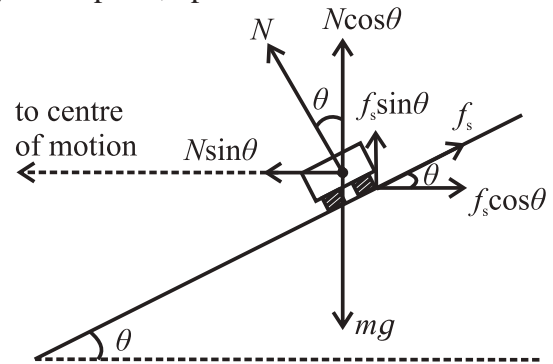

Fig 1.7: Banked road : lower speed limit.

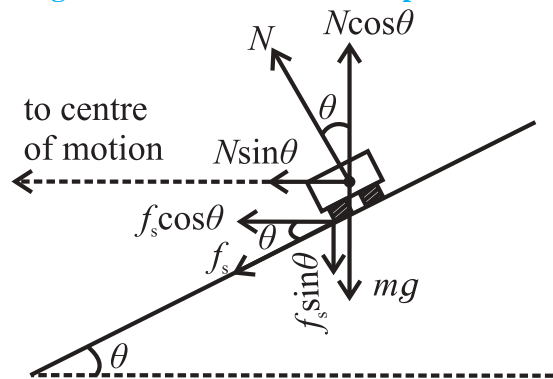

Fig 1.8: Banked road : upper speed limit.

For speeds $v_1 < \sqrt{rg \tan \theta}$, $\frac{mv_1^2}{r} < N \sin \theta$ (or $N \sin \theta$ is greater than the centrifugal force $\frac{mv_1^2}{r}$). In this case, the direction of force of static friction f_s between road and the tyres is directed along the inclination of the road, upwards (Fig. 1.7). Its horizontal component is parallel and opposite to $N \sin \theta$. These two

forces take care of the necessary centripetal force (or balance the centrifugal force).

$$\therefore mg = f_s \sin \theta + N \cos \theta \text{ and}$$

$$\frac{mv_1^2}{r} = N \sin \theta - f_s \cos \theta$$

For minimum possible speed, f_s is maximum and equal to $\mu_s N$. Using this in the equations above and solving for minimum possible speed, we get

$$(v_1)_{\min} = v_{\min} = \sqrt{rg \left(\frac{\tan \theta - \mu_s}{1 + \mu_s \tan \theta} \right)} \quad \text{--- (1.3)}$$

For $\mu_s \geq \tan \theta$, $v_{\min} = 0$. This is true for most of the rough roads, banked at smaller angles.

(d) For speeds $v_2 > \sqrt{rg \tan \theta}$, $\frac{mv_2^2}{r} > N \sin \theta$

(or $N \sin \theta$ is less than the centrifugal force $\frac{mv_2^2}{r}$). In this case, the direction of force of static friction f_s between road and the tyres is directed along the inclination of the road, downwards (Fig. 1.8). Its horizontal component is parallel to $N \sin \theta$. These two forces take care of the necessary centripetal force (or balance the centrifugal force).

$$\therefore mg = N \cos \theta - f_s \sin \theta \text{ and}$$

$$\frac{mv_2^2}{r} = N \sin \theta + f_s \cos \theta$$

For maximum possible speed, f_s is maximum and equal to $\mu_s N$. Using this in the equations above, and solving for maximum possible speed, we get

$$(v_2)_{\max} = v_{\max} = \sqrt{rg \left(\frac{\tan \theta + \mu_s}{1 - \mu_s \tan \theta} \right)} \quad \text{--- (1.4)}$$

If $\mu_s = \cot \theta$, $v_{\max} = \infty$. But $(\mu_s)_{\max} = 1$. Thus, for $\theta \geq 45^\circ$, $v_{\max} = \infty$. However, for heavily banked road, minimum limit may be important. *Try to relate the concepts used while explaining the well of death.*

(e) For $\mu_s = 0$, both the equations 1.3 and 1.4 give us $v = \sqrt{rg \tan \theta}$ which is the *safest* speed on a banked road as we don't take the help of friction.

Example 3: A racing track of curvature 9.9 m is banked at $\tan^{-1} 0.5$. Coefficient of static friction between the track and the tyres of a vehicle is 0.2. Determine the speed limits with 10 % margin.

Solution:

$$\begin{aligned} v_{\min} &= \sqrt{rg \left(\frac{\tan \theta - \mu_s}{1 + \mu_s \tan \theta} \right)} \\ &= \sqrt{9.9 \times 10 \left(\frac{0.5 - 0.2}{1 + (0.2 \times 0.5)} \right)} \\ &= \sqrt{27} = 5.196 \text{ m/s} \end{aligned}$$

Allowed v_{\min} should be 10% higher than this.

$$\begin{aligned} \therefore (v_{\min})_{\text{allowed}} &= 5.196 \times \frac{110}{100} \\ &= 5.716 \frac{\text{m}}{\text{s}} \end{aligned}$$

$$\begin{aligned} v_{\max} &= \sqrt{rg \left(\frac{\tan \theta + \mu_s}{1 - \mu_s \tan \theta} \right)} \\ &= \sqrt{9.9 \times 10 \left(\frac{0.5 + 0.2}{1 - (0.2 \times 0.5)} \right)} \\ &= \sqrt{77} = 8.775 \text{ m/s} \end{aligned}$$

Allowed v_{\max} should be 10% lower than this.

$$\therefore (v_{\max})_{\text{allowed}} = 8.775 \times \frac{90}{100} = 7.896 \text{ m/s}$$



Use your brain power

- If friction is zero, can a vehicle move on the road? Why are we not considering the friction in deriving the expression for the banking angle?
- What about the kinetic friction between the road and the tyres?

1.3.4 Conical Pendulum:

A tiny mass (assumed to be a point object and called a bob) connected to a long, flexible, massless, inextensible string, and suspended to a rigid support is called a pendulum. If the

string is made to oscillate in a single vertical plane, we call it a *simple pendulum* (to be studied in the Chapter 5).

We can also revolve the string in such a way that the string moves along the surface of a right circular cone of vertical axis and the point object performs a (practically) uniform horizontal circular motion. In such a case the system is called a *conical pendulum*.

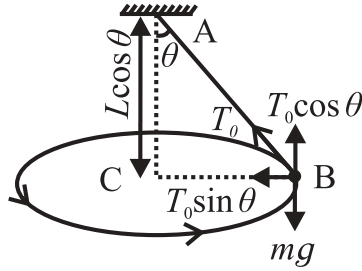

Fig. 1.9 (a): In an inertial frame

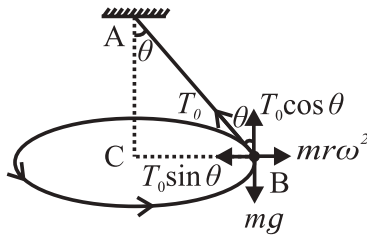

Fig. 1.9 (b): In a non-inertial frame

Figure 1.9 shows the vertical section of a conical pendulum having bob (point mass) of mass m and string of length L . In a given position B, the forces acting on the bob are (i) its weight mg directed vertically downwards and (ii) the force T_0 due to the tension in the string, directed along the string, towards the support A. As the motion of the bob is a horizontal circular motion, the resultant force must be horizontal and directed towards the centre C of the circular motion. For this, all the vertical forces must cancel. Hence, we shall resolve the force T_0 due to the tension. If θ is the angle made by the string with the vertical, at any position (semi-vertical angle of the cone), the vertical component $T_0 \cos \theta$ balances the weight mg . The horizontal component $T_0 \sin \theta$ then becomes the resultant force which is *centripetal*.

$$\therefore T_0 \sin \theta = \text{centripetal force} = mr\omega^2 \quad \text{--- (1.5)}$$

$$\text{Also, } T_0 \cos \theta = mg \quad \text{--- (1.6)}$$

Dividing eq (1.5) by Eq. (1.6), we get,

$$\omega^2 = \frac{g \sin \theta}{r \cos \theta}$$

Radius r of the circular motion is $r = L \sin \theta$.

If T is the period of revolution of the bob,

$$\omega = \frac{2\pi}{T} = \sqrt{\frac{g}{L \cos \theta}}$$

$$\therefore \text{Period } T = 2\pi \sqrt{\frac{L \cos \theta}{g}} \quad \text{--- (1.7)}$$

Frequency of revolution,

$$n = \frac{1}{T} = \frac{1}{2\pi} \sqrt{\frac{g}{L \cos \theta}} \quad \text{--- (1.8)}$$

In the frame of reference attached to the bob, the centrifugal force should balance the resultant of all the real forces (which we call CPF) for the bob to be at rest.

$\therefore T_0 \sin \theta = mr\omega^2$ --- (in magnitude). This is the same as the Eq. (1.5)

Do you know?

- (i) For a given set up, L and g are constant. Thus, both period and frequency depend upon θ .
- (ii) During revolutions, the string can NEVER become horizontal. This can be explained in two different ways.
 - (a) If the string becomes horizontal, the force due to tension will also be horizontal. Its vertical component will then be zero. In this case, nothing will be there to balance mg .
 - (b) For horizontal string, $\theta = 90^\circ$. This will indicate the frequency to be infinite and the period to be zero, which are impossible. Also, in this case, the tension $T_0 = \frac{mg}{\cos \theta}$ in the string and the kinetic energy $= \frac{1}{2}mv^2 = \frac{1}{2}mr^2\omega^2$ of the bob will be infinite.

Activity

A stone is tied to a string and whirled such that the stone performs horizontal circular motion. It can be seen that the string is NEVER horizontal.

Example 1.4: A merry-go-round usually consists of a central vertical pillar. At the top of it there are horizontal rods which can rotate about vertical axis. At the end of this horizontal rod there is a vertical rod fitted like an elbow joint. At the lower end of each vertical rod, there is a horse on which the rider can sit. As the merry-go-round is set into rotation, these vertical rods move away from the axle by making some angle with the vertical.

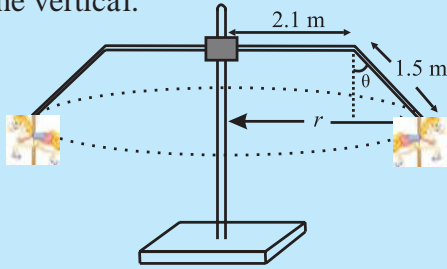

The figure above shows vertical section of a merry-go-round in which the 'initially vertical' rods are inclined with the vertical at 37° , during rotation. Calculate the frequency of revolution of the merry-go-round.

(Use $g = \pi^2 \text{ m/s}^2$ and $\sin 37^\circ = 0.6$)

Solution: Length of the horizontal rod, $H = 2.1 \text{ m}$

Length of the 'initially vertical' rod, $V = 1.5 \text{ m}$, $\theta = 37^\circ$

\therefore Radius of the horizontal circular motion of the rider $= H + V \sin 37^\circ = 3.0 \text{ m}$

If T is the tension along the inclined rod,

$T \cos \theta = mg$ and $T \sin \theta = mr\omega^2 = 4\pi^2 mrn^2$

$$\therefore \tan \theta = \frac{4\pi^2 rn^2}{g}$$

$$\therefore n = \sqrt{\frac{\tan \theta}{4r}} = \frac{1}{4} \text{ rev s}^{-1} \quad \dots \text{ as } g = \pi^2$$

Example 1.5: Semi-vertical angle of the conical section of a funnel is 37° . There is a small ball kept inside the funnel. On rotating the funnel, the maximum speed that the ball can have in order to remain in the funnel is 2 m/s . Calculate inner radius of the brim of the funnel. Is there any limit upon the frequency of rotation? How much is it? Is it lower or upper limit? Give a logical reasoning. (Use $g = 10 \text{ m/s}^2$ and $\sin 37^\circ = 0.6$)

Solution: $N \sin \theta = mg$ and $N \cos \theta = \frac{mv^2}{r}$

$$\therefore \tan \theta = \frac{rg}{v^2} \therefore r = \frac{v^2 \tan \theta}{g}$$

$$\therefore r_{\max} = \frac{v_{\max}^2 \tan \theta}{g} = 0.3 \text{ m}$$

$$v = r\omega = 2\pi rn$$

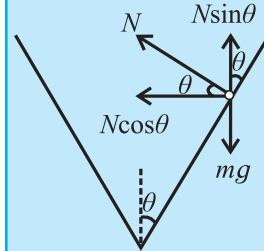

If we go for the lower limit of the speed (while rotating),

$v \rightarrow 0 \therefore r \rightarrow 0$, but the frequency n increases.

Hence a specific upper

limit is not possible in the case of frequency.

Thus, the practical limit on the frequency of rotation is its lower limit. It will be possible

for $r = r_{\max}$

$$\therefore n_{\min} = \frac{v_{\max}}{2\pi r_{\max}} = \frac{1}{0.3\pi} \cong 1 \text{ rev / s}$$



Activity

Using a funnel and a marble or a ball bearing try to work out the situation in the above question. Try to realize that as the marble goes towards the brim, its linear speed increases but its angular speed decreases. When nearing the base, it is the other way.

1.4 Vertical Circular Motion:

Two types of vertical circular motions are commonly observed in practice:

- A controlled vertical circular motion such as a giant wheel or similar games. In this case the speed is either kept constant or NOT totally controlled by gravity.
- Vertical circular motion controlled *only* by gravity. In this case, we initially supply the necessary energy (mostly) at the lowest point. Then onwards, the entire kinetics is governed by the gravitational force. During the motion, there is interconversion of kinetic energy and gravitational potential energy.

1.4.1 Point Mass Undergoing Vertical Circular Motion Under Gravity:

Case I: Mass tied to a string:

The figure 1.10 shows a bob (treated as a point mass) tied to a (practically) massless, inextensible and flexible string. It is whirled along a vertical circle so that the bob performs a vertical circular motion and the string rotates in a vertical plane. At any position of the bob, there are only two forces acting on the bob:

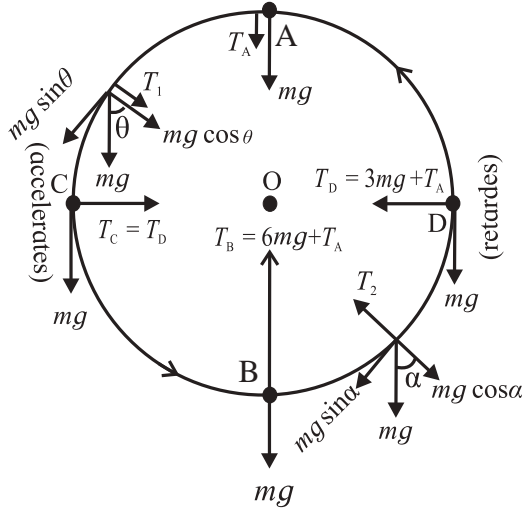

Fig 1.10: Vertical circular motion.

(a) its weight mg , vertically downwards, which is constant and (b) the force due to the tension along the string, directed along the string and towards the centre. Its magnitude changes periodically with time and location.

As the motion is non uniform, the resultant of these two forces is *not* directed towards the center *except* at the uppermost and the lowermost positions of the bob. At all the other positions, part of the resultant is tangential and is used to change the speed.

Uppermost position (A): Both, weight mg and force due to tension T_A are downwards, i.e., towards the centre. In this case, their resultant is used only as the centripetal force. Thus, if v_A is the speed at the uppermost point, we get,

$$mg + T_A = \frac{mv_A^2}{r} \quad \text{--- (1.9)}$$

Radius r of the circular motion is the length of the string. For minimum possible speed at this point (or if the motion is to be

realized with minimum possible energy),

$$T_A = 0 \therefore (v_A)_{\min} = \sqrt{rg} \quad \text{--- (1.10)}$$

Lowermost position (B): Force due to the tension, T_B is vertically upwards, i.e., towards the centre, and opposite to mg . In this case also their resultant is the centripetal force. If v_B is the speed at the lowermost point, we get,

$$T_B - mg = \frac{mv_B^2}{r} \quad \text{--- (1.11)}$$

While coming down from the uppermost to the lowermost point, the vertical displacement is $2r$ and the motion is governed only by gravity. Hence the corresponding decrease in the gravitational potential energy is converted into the kinetic energy.

$$\begin{aligned} \therefore mg(2r) &= \frac{1}{2}mv_B^2 - \frac{1}{2}mv_A^2 \\ \therefore v_B^2 - v_A^2 &= 4rg \end{aligned} \quad \text{--- (1.12)}$$

Using this in the eq (1.11), and using $(v_A)_{\min}$ from Eq. (1.10) we get,

$$(v_B)_{\min} = \sqrt{5rg} \quad \text{--- (1.13)}$$

Subtracting eq (1.9) from eq (1.11), we can write,

$$T_B - T_A - 2mg = \frac{m}{r}(v_B^2 - v_A^2) \quad \text{--- (1.14)}$$

Using eq (1.12) and rearranging, we get,

$$T_B - T_A = 6mg \quad \text{--- (1.15)}$$

Positions when the string is horizontal (C and D): Force due to the tension is the only force towards the centre as weight mg is perpendicular to the tension. Thus, force due to the tension is the centripetal force used to change the direction of the velocity and weight mg is used only to change the speed.

Using similar mathematics, it can be shown that

$$\begin{aligned} T_C - T_A &= T_D - T_A = 3mg \quad \text{and} \\ (v_C)_{\min} &= (v_D)_{\min} = \sqrt{3rg} \end{aligned}$$

Arbitrary positions: Force due to the tension and weight are neither along the same line, nor perpendicular. Tangential component of weight is used to change the speed. It decreases the speed while going up and increases it while coming down.

**Remember this**

- Equation (1.15) is independent of v and r .
- T_A can never be exactly equal to zero in the case of a string, else, the string will slack. $\therefore T_B > 6mg$.
- None of the parameters (including the linear and angular accelerations) are constant during such a motion. Obviously, kinematical equations given in the table 1 are not applicable.
- We can determine the position vector or velocity at any instant using the energy conservation. But as the function of the radius vector is not integrable (definite integration is not possible), *theoretically* it is *not* possible to determine the period or frequency. However, experimentally the period can be measured.
- Equations (1.10) and (1.13) give only the respective *minimum* speeds at the uppermost and the lowermost points. Any higher speeds obeying the equation (1.14) are allowed.
- In reality, we have to continuously supply some energy to overcome the air resistance.

Case II: Mass tied to a rod: Consider a bob (point mass) tied to a (practically massless and rigid) rod and whirled along a vertical circle. *The basic difference between the rod and the string is that the string needs some tension at all the points, including the uppermost point.* Thus, a certain minimum speed, Eq. (1.10), is necessary at the uppermost point in the case of a string. In the case of a rod, as the rod is rigid, such a condition is not necessary. Thus (practically) zero speed is possible at the uppermost point.

Using similar mathematics, it is left to the readers to show that

$$(v_{\text{lowermost}})_{\text{min}} = \sqrt{4rg} = 2\sqrt{rg}$$

$$v_{\text{min}} \text{ at the rod horizontal position} = \sqrt{2rg}$$

$$T_{\text{lowermost}} - T_{\text{uppermost}} = 6mg$$

1.4.2 Sphere of Death (मृत्यु गोल):

This is a popular show in a circus. During this, two-wheeler rider (or riders) undergo rounds inside a hollow sphere. Starting with small horizontal circles, they eventually perform revolutions along vertical circles. The dynamics of this vertical circular motion is the same as that of the point mass tied to the string, except that the force due to tension T is replaced by the normal reaction force N .

If you have seen this show, try to visualize that initially there are nearly horizontal circles. The linear speed is more for larger circles but angular speed (frequency) is more for smaller circles (while starting or stopping). This is as per the theory of conical pendulum.

1.4.3 Vehicle at the Top of a Convex Over-Bridge:

Fig. 1.11: Vehicle on a convex over-bridge.

Figure shows a vehicle at the top of a convex over bridge, during its motion (part of vertical circular motion). Forces acting on the vehicle are (a) Weight mg and (b) Normal reaction force N , both along the vertical line (topmost position). The resultant of these two must provide the necessary centripetal force (vertically downwards) if the vehicle is at the uppermost position. Thus, if v is the speed at the uppermost point,

$$mg - N = \frac{mv^2}{r}$$

As the speed is increased, N goes on decreasing. Normal reaction is an indication of contact. Thus, for just maintaining contact, $N = 0$. This imposes an upper limit on the speed as $v_{\text{max}} = \sqrt{rg}$

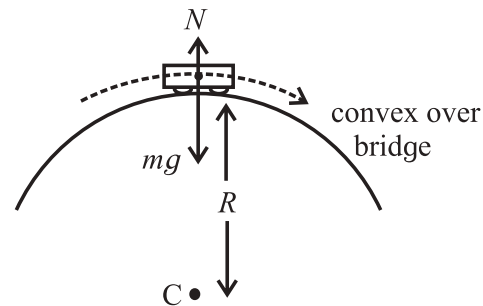
**Do you know?**

Roller coaster is a common event in the amusement parks. During this ride, all the parts of the vertical circular motion described above can be experienced. The major force that we experience during this is the normal reaction force. Those who have experienced this, should try to recall the changes in the normal reaction experienced by us during various parts of the track.

**Use your brain power**

- What is expected to happen if one travels fast over a speed breaker? Why?
- How does the normal force on a concave suspension bridge change when a vehicle is travelling on it with constant speed?

Example 1.6: A tiny stone of mass 20 g is tied to a practically massless, inextensible, flexible string and whirled along vertical circles. Speed of the stone is 8 m/s when the centripetal force is exactly equal to the force due to the tension.

Calculate minimum and maximum kinetic energies of the stone during the entire circle.

Let $\theta = 0$ be the angular position of the string, when the stone is at the lowermost position. Determine the angular position of the string when the force due to tension is numerically equal to weight of the stone.

Use $g = 10 \text{ m/s}^2$ and length of the string = 1.8 m

Solution: When the string is horizontal, the force due to the tension is the centripetal force. Thus, vertical displacements of the bob for minimum and maximum energy positions are radius r each.

If $K.E._{\text{max}}$ and $K.E._{\text{min}}$ are the respective kinetic energies at the uppermost and the lowermost points,

$$K.E._{\text{max}} - \frac{1}{2}m(8)^2 = mgr \quad \text{and}$$

$$\frac{1}{2}m(8)^2 - K.E._{\text{min}} = mgr$$

$$\therefore \frac{1}{2}(0.02)(8)^2 - K.E._{\text{min}} = (0.02)(10)(1.8)$$

$$\therefore K.E._{\text{min}} = 0.28 \text{ J}$$

$$K.E._{\text{max}} - \frac{1}{2}(0.02)(8)^2 = (0.02)(10)(1.8)$$

$$\therefore K.E._{\text{max}} = \frac{1}{2}mv_{\text{max}}^2 = 1 \text{ J}$$

$$\therefore v_{\text{max}} = \sqrt{\frac{2(K.E.)_{\text{max}}}{m}} = 10 \text{ m s}^{-1}$$

at the lowermost position, for which $\theta = 0$.

$$T - mg \cos \theta = \frac{mv^2}{r} \quad \text{--- at any angle } \theta,$$

where the speed is v .

Thus, if $T = mg$, we get,

$$mg - mg \cos \theta = \frac{mv^2}{r}$$

$$\therefore rg(1 - \cos \theta) = v^2 \quad \text{--- (A)}$$

Vertical displacement at the angular position θ is $r(1 - \cos \theta)$. Thus, the energy equation at this position can be written as

$$\frac{1}{2}m(10)^2 - \frac{1}{2}mv^2 = mg[r(1 - \cos \theta)]$$

By using Eq. A, we get

$$50 - \frac{1}{2}rg(1 - \cos \theta) = rg(1 - \cos \theta)$$

$$\therefore 50 = \frac{3}{2}rg(1 - \cos \theta)$$

$$\therefore \cos \theta = \frac{-23}{27} \therefore \theta = 148^\circ 25'$$

1.5 Moment of Inertia as an Analogous Quantity for Mass:

In XIth Std. we saw that angular displacement, angular velocity and angular acceleration respectively replace displacement, velocity and acceleration for various kinematical equations. Also, torque is an analogous quantity for force. Expressions of linear momentum, force (for a fixed mass) and kinetic energy include mass as a common term. In order to have their rotational analogues, we need a replacement for mass.

If we open a door (with hinges), we give a certain angular displacement to it. The efforts

needed for this depend not only upon the mass of the door, but also upon the (perpendicular) distance from the axis of rotation, where we apply the force. Thus, the quantity analogous to mass includes not only the mass, but also takes care of the distance wise distribution of the mass around the axis of rotation. To know the exact relation, let us derive an expression for the rotational kinetic energy which is the sum of the translational kinetic energies of all the individual particles.

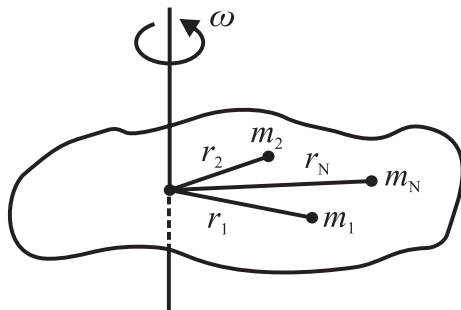

Fig. 1.12: A body of N particles.

Figure 1.12 shows a rigid object rotating with a constant angular speed ω about an axis perpendicular to the plane of paper. For theoretical simplification let us consider the object to be consisting of N particles of masses m_1, m_2, \dots, m_N at respective perpendicular distances r_1, r_2, \dots, r_N from the axis of rotation. As the object rotates, all these particles perform UCM with the same angular speed ω , but with different linear speeds $v_1 = r_1\omega, v_2 = r_2\omega, \dots, v_N = r_N\omega$.

Translational K.E. of the first particle is

$$\text{K.E.}_1 = \frac{1}{2} m_1 v_1^2 = \frac{1}{2} m_1 r_1^2 \omega^2$$

Similar will be the case of all the other particles. Rotational K.E. of the object, is the sum of individual translational kinetic energies. Thus, rotational K.E.

$$= \frac{1}{2} m_1 r_1^2 \omega^2 + \frac{1}{2} m_2 r_2^2 \omega^2 + \dots + \frac{1}{2} m_N r_N^2 \omega^2$$

\therefore Rotational K.E.

$$= \frac{1}{2} (m_1 r_1^2 + m_2 r_2^2 + \dots + m_N r_N^2) \omega^2 = \frac{1}{2} I \omega^2$$

Where $I = m_1 r_1^2 + m_2 r_2^2 + \dots + m_N r_N^2 = \sum_{i=1}^N m_i r_i^2$

If $I = \sum m_i r_i^2$ replaces mass m and angular speed ω replaces linear speed v , rotational K.E. = $\frac{1}{2} I \omega^2$ is analogous to translational K.E. = $\frac{1}{2} m v^2$. Thus, I is defined to be the rotational inertia or moment of inertia (M.I.) of the object about the given axis of rotation. It is clear that the moment of inertia of an object depends upon (i) individual masses and (ii) the distribution of these masses about the given axis of rotation. For a different axis, it will again depend upon the mass distribution around that axis and will be different if there is no symmetry.

During this discussion, for simplicity, we assumed the object to be consisting of a finite number of particles. In practice, usually, it is not so. For a homogeneous rigid object of mathematically integrable mass distribution, the moment of inertia is to be obtained by integration as $I = \int r^2 dm$. If integrable mass distribution is not known, it is not possible to obtain the moment of inertia theoretically, but it can be determined experimentally.

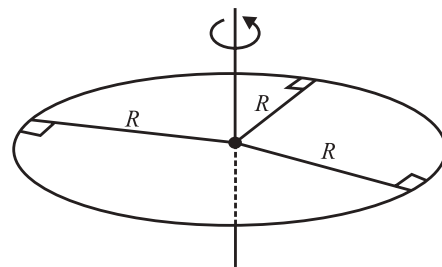

Fig. 1.13: Moment of Inertia of a ring.

1.5.1 Moment of Inertia of a Uniform Ring:

An object is called a uniform ring if its mass is (practically) situated uniformly on the circumference of a circle (Fig 1.13). Obviously, it is a two dimensional object of negligible thickness. If it is rotating about its own axis (line perpendicular to its plane and passing through its centre), its entire mass M is practically at a distance equal to its radius R from the axis. Hence, the expression for the moment of inertia of a uniform ring of mass M and radius R is $I = MR^2$.

1.5.2 Moment of Inertia of a Uniform Disc:

Disc is a two dimensional circular object of negligible thickness. It is said to be uniform if its mass per unit area and its composition is the same throughout. The ratio $\sigma = \frac{m}{A} = \frac{\text{mass}}{\text{area}}$ is called the surface density.

Consider a uniform disc of mass M and radius R rotating about its own axis, which is the line perpendicular to its plane and passing through its centre $\therefore \sigma = \frac{M}{\pi R^2}$.

As it is a uniform circular object, it can be considered to be consisting of a number of concentric rings of radii increasing from (practically) zero to R . One of such rings of mass dm is shown by shaded portion in the Fig. 1.14.

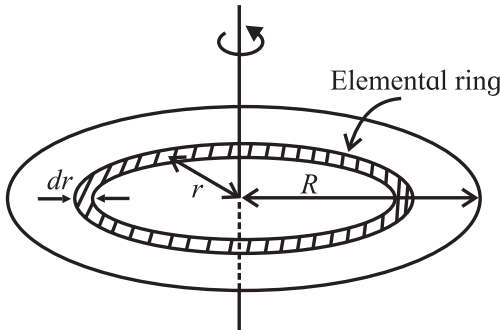

Fig .1.14: Moment of Inertia of a disk.

Width of this ring is dr , which is so small that the entire ring can be considered to be of average radius r . (In practical sense, dr is less than the least count of the instrument that measures r , so that r is constant for that ring). Area of this ring is $A = 2\pi r.dr \therefore \sigma = \frac{dm}{2\pi r.dr}$
 $\therefore dm = 2\pi\sigma r.dr$.

As it is a ring, this entire mass is at a distance r from the axis of rotation. Thus, the moment of inertia of this ring is $I_r = dm (r^2)$

Moment of inertia (I) of the disc can now be obtained by integrating I_r from $r = 0$ to $r = R$.

$$\therefore I = \int_0^R I_r = \int_0^R dm \cdot r^2 = \int_0^R 2\pi\sigma r \cdot dr \cdot r^2 = 2\pi\sigma \int_0^R r^3 \cdot dr$$

$$\therefore I = 2\pi\sigma \left(\frac{R^4}{4} \right) = 2\pi \left(\frac{M}{\pi R^2} \right) \left(\frac{R^4}{4} \right) = \frac{1}{2} MR^2$$

Using similar method, expressions for moment

of inertias of objects of several integrable geometrical shapes can be derived. Some of those are given in the Table 3 at the end of the topic.

1.6 Radius of Gyration:

As stated earlier, theoretical calculation of moment of inertia is possible only for mathematically integrable geometrical shapes. However, experimentally we can determine the moment of inertia of any object. It depends upon mass of that object and how that mass is distributed from or around the given axis of rotation. If we are interested in knowing only the mass distribution around the axis of rotation, we can express moment of inertia of any object as $I = MK^2$, where M is mass of that object. It means that the mass of that object is effectively at a distance K from the given axis of rotation. In this case, K is defined as the *radius of gyration* of the object about the given axis of rotation. In other words, if K is radius of gyration for an object, $I = MK^2$ is the moment of inertia of that object. Larger the value of K , *farther* is the mass from the axis.

Consider a uniform ring and a uniform disc, both of the same mass M and same radius R . Let I_r and I_d be their respective moment of inertias.

If K_r and K_d are their respective radii of gyration, we can write,

$$I_r = MR^2 = MK_r^2 \therefore K_r = R \text{ and } I_d = \frac{1}{2} MR^2 = MK_d^2 \therefore K_d = \frac{R}{\sqrt{2}} \therefore K_d < K_r$$

It shows mathematically that K is decided by the distribution of mass. In a ring the entire mass is distributed at the distance R , while for a disc, its mass is distributed between 0 and R . Among any objects of same mass and radius, ring has the largest radius of gyration and hence maximum M.I.

1.7 Theorem of Parallel Axes and Theorem of Perpendicular Axes:

Expressions of moment of inertias of

regular geometrical shapes given in the table 3 are about their axes of symmetry. These are derived by integration. However, every time the axis need not be the axis of symmetry. In simple transformations it may be parallel or perpendicular to the symmetrical axis. For example, if a rod is rotated about one of its ends, the axis is parallel to its axis of symmetry. If a disc or a ring is rotated about its diameter, the axis is perpendicular to the central axis. In such cases, simple transformations are possible in the expressions of moment of inertias. These are called theorem of parallel axes and theorem of perpendicular axes.

1.7.1 Theorem of Parallel Axes:

In order to apply this theorem to *any* object, we need two axes parallel to each other with one of them passing through the centre of mass of the object.

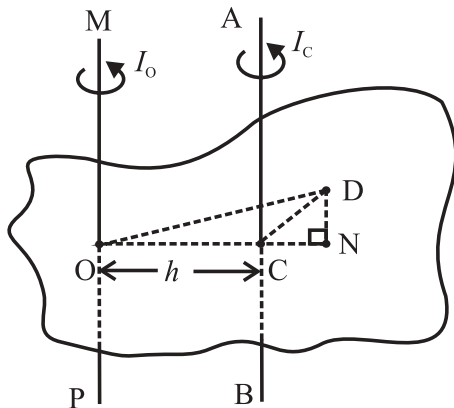

Fig. 1.15: Theorem of parallel axes.

Figure 1.15 shows an object of mass M . Axis MOP is any axis passing through point O. Axis ACB is passing through the centre of mass C of the object, parallel to the axis MOP, and at a distance h from it ($\therefore h = CO$). Consider a mass element dm located at point D. Perpendicular on OC (produced) from point D is DN. Moment of inertia of the object about the axis ACB is $I_c = \int (DC)^2 dm$, and about the axis MOP it is $I_o = \int (DO)^2 dm$.

$$\begin{aligned} \therefore I_o &= \int (DO)^2 dm = \int ([DN]^2 + [NO]^2) dm \\ &= \int ([DN]^2 + [NC]^2 + 2.NC.CO + [CO]^2) dm \end{aligned}$$

$$\begin{aligned} &= \int ([DC]^2 + 2NC.h + h^2) dm \\ &= \int (DC)^2 dm + 2h \int NC.dm + h^2 \int dm \\ \text{Now, } \int (DC)^2 dm &= I_c \text{ and } \int dm = M. \end{aligned}$$

NC is the distance of a point from the centre of mass. Any mass distribution is symmetric about the centre of mass. Thus, from the definition of the centre of mass, $\int NC.dm = 0$.

$$\therefore I_o = I_c + M.h^2$$

This is the mathematical form of the theorem of parallel axes.

It states that, “The moment of inertia (I_o) of an object about any axis is the sum of its moment of inertia (I_c) about an axis parallel to the given axis, and passing through the centre of mass *and* the product of the mass of the object and the square of the distance between the two axes (Mh^2).”



Use your brain power

In Fig. 1.15, the point D is chosen such that we have to extend OC for the perpendicular DN to fall on it. What will happen to the final expression of I_o , if point D is so chosen that the perpendicular DN falls directly on OC?

1.7.2 Theorem of Perpendicular Axes:

This theorem relates the moment of inertias of a *laminar* object about three mutually perpendicular and concurrent axes, two of them in the plane of the object and the third perpendicular to the object. *Laminar* object is like a leaf, or any two dimensional object, e.g., a ring, a disc, any plane sheet, etc.

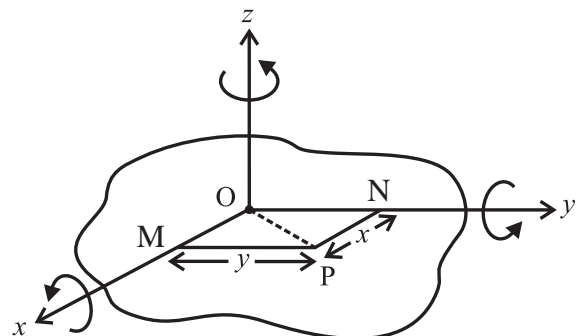

Fig. 1.16: Theorem of perpendicular axes.

Figure 1.16 shows a rigid lamina object able to rotate about three mutually perpendicular axes x , y and z . Axes x and y are in the plane of the object while the z axis is perpendicular to it, and all are concurrent at O . Consider a mass element dm located at any point P . $PM = y$ and $PN = x$ are the perpendiculars drawn from P respectively on the x and y axes. The respective perpendicular distances of point M from x , y and z axes will then be y , x and $\sqrt{y^2 + x^2}$. If I_x , I_y and I_z are the respective moment of inertias of the body about x , y and z axes, we can write,

$$\therefore I_x = \int y^2 dm, I_y = \int x^2 dm \text{ and}$$

$$I_z = \int (y^2 + x^2) dm$$

$$\therefore I_z = \int y^2 dm + \int x^2 dm = I_x + I_y$$

This is the mathematical form of the theorem of perpendicular axes.

It states that, "The moment of inertia (I_z) of a lamina object about an axis (z) perpendicular to its plane is the sum of its moment of inertias about two mutually perpendicular axes (x and y) in its plane, all the three axes being concurrent".

Example 1.7: A flywheel is a mechanical device specifically designed to efficiently store rotational energy. For a particular machine it is in the form of a uniform 20 kg disc of diameter 50 cm, able to rotate about its own axis. Calculate its kinetic energy when rotating at 1200 rpm. Use $\pi^2 = 10$. Calculate its moment of inertia, in case it is rotated about a tangent in its plane.

Solution: (I) As the flywheel is in the form of a uniform disc rotating about its own axis, $I_z = \frac{1}{2} MR^2$

\therefore Rotational kinetic energy

$$= \frac{1}{2} I \omega^2 = \frac{1}{2} \left(\frac{1}{2} MR^2 \right) 4\pi^2 n^2$$

\therefore Rotational kinetic energy

$$= M\pi^2 (Rn)^2 = 20 \times 10 \times (0.25 \times 20)^2 = 5000 \text{ J}$$

(II) Consider any two mutually perpendicular diameters x and y of the flywheel. If the flywheel rotates about these diameters, these three axes (own axis and two diameters) will be mutually perpendicular and concurrent. Thus, perpendicular axes theorem is applicable. Let I_d be the moment of inertia of the flywheel, when rotating about its diameter. $\therefore I_d = I_x = I_y$

Thus, according to the theorem of perpendicular axes,

$$I_z = \frac{1}{2} MR^2 = I_x + I_y = 2I_d$$

$$\therefore I_d = \frac{1}{4} MR^2$$

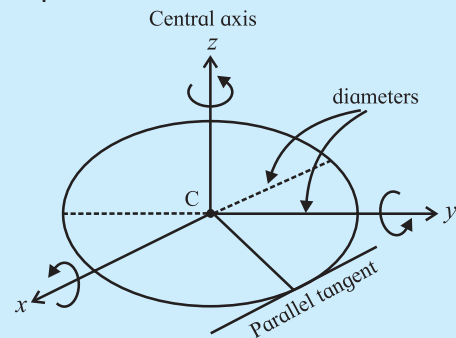

As the diameter passes through the centre of mass of the (uniform) disc, $I_d = I_c$

Consider a tangent in the plane of the disc and parallel to this diameter. It is at the distance $h = R$ from the diameter. Thus, parallel axes theorem is applicable about these two axes.

$$\therefore I_{T, \text{parallel}} = I_o = I_c + Mh^2 = I_d + MR^2$$

$$= \frac{1}{4} MR^2 + MR^2 = \frac{5}{4} MR^2$$

$$\therefore I_{T, \text{parallel}} = \frac{5}{4} MR^2 = \frac{5}{4} 20 \times 0.25^2 = 1.5625 \text{ kg m}^2$$

1.8 Angular Momentum or Moment of Linear Momentum:

The quantity in rotational mechanics, analogous to linear momentum is *angular momentum* or moment of linear momentum. It is similar to the torque being moment of a force. If \vec{p} is the instantaneous linear momentum of a particle undertaking a circular motion, its

angular momentum at that instance is given by $\vec{L} = \vec{r} \times \vec{p}$, where \vec{r} is the position vector from the axis of rotation.

In magnitude, it is the product of linear momentum and its perpendicular distance from the axis of rotation. $\therefore L = P \times r \sin \theta$, where θ is the smaller angle between the directions of \vec{P} and \vec{r} .

1.8.1 Expression for Angular Momentum in Terms of Moment of Inertia:

Figure 1.12 in the section 1.5 shows a rigid object rotating with a constant angular speed ω about an axis perpendicular to the plane of paper. For theoretical simplification let us consider the object to be consisting of N number of particles of masses m_1, m_2, \dots, m_N at respective perpendicular distances r_1, r_2, \dots, r_N from the axis of rotation. As the object rotates, all these particles perform UCM with same angular speed ω , but with different linear speeds $v_1 = r_1 \omega, v_2 = r_2 \omega, \dots, v_N = r_N \omega$.

Directions of individual velocities $\vec{v}_1, \vec{v}_2, \dots$, are along the tangents to their respective tracks. Linear momentum of the first particle is of magnitude $p_1 = m_1 v_1 = m_1 r_1 \omega$. Its direction is along that of \vec{v}_1 .

Its angular momentum is thus of magnitude $L_1 = p_1 r_1 = m_1 r_1^2 \omega$

Similarly, $L_2 = m_2 r_2^2 \omega, L_3 = m_3 r_3^2 \omega, \dots, L_N = m_N r_N^2 \omega$

For a rigid body with a fixed axis of rotation, all these angular momenta are directed along the axis of rotation, and this direction can be obtained by using right hand thumb rule. As all of them have the same direction, their magnitudes can be algebraically added. Thus, magnitude of angular momentum of the body is given by

$$L = m_1 r_1^2 \omega + m_2 r_2^2 \omega + \dots + m_N r_N^2 \omega$$

$$= (m_1 r_1^2 + m_2 r_2^2 + \dots + m_N r_N^2) \omega = I \omega$$

Where, $I = m_1 r_1^2 + m_2 r_2^2 + \dots + m_N r_N^2$ is the moment of inertia of the body about the given

axis of rotation. The expression for angular momentum $L = I \omega$ is analogous to the expression $p = mv$ of linear momentum, if the moment of inertia I replaces mass, which is its physical significance.

1.9 Expression for Torque in Terms of Moment of Inertia:

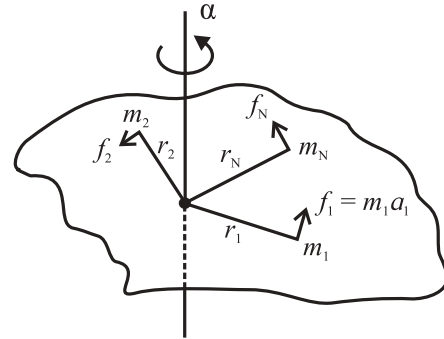

Fig 1.17: Expression for torque.

Figure 1.17 shows a rigid object rotating with a constant angular acceleration α about an axis perpendicular to the plane of paper. For theoretical simplification let us consider the object to be consisting of N number of particles of masses m_1, m_2, \dots, m_N at respective perpendicular distances r_1, r_2, \dots, r_N from the axis of rotation. As the object rotates, all these particles perform circular motion with same angular acceleration α , but with different linear (tangential) accelerations $a_1 = r_1 \alpha, a_2 = r_2 \alpha, \dots, a_N = r_N \alpha$, etc.

Force experienced by the first particle is $f_1 = m_1 a_1 = m_1 r_1 \alpha$

As these forces are tangential, their respective perpendicular distances from the axis are r_1, r_2, \dots, r_N .

Thus, the torque experienced by the first particle is of magnitude $\tau_1 = f_1 r_1 = m_1 r_1^2 \alpha$

Similarly, $\tau_2 = m_2 r_2^2 \alpha, \tau_3 = m_3 r_3^2 \alpha, \dots, \tau_N = m_N r_N^2 \alpha$

If the rotation is restricted to a single plane, directions of all these torques are the same, and along the axis. Magnitude of the resultant torque is then given by

$$\tau = \tau_1 + \tau_2 + \dots + \tau_N$$

$$= (m_1 r_1^2 + m_2 r_2^2 + \dots + m_N r_N^2) \alpha = I \alpha$$

where, $I = m_1 r_1^2 + m_2 r_2^2 \dots + m_N r_N^2$ is the moment of inertia of the object about the given axis of rotation.

The relation $\tau = I\alpha$ is analogous to $f = ma$ for the translational motion if the moment of inertia I replaces mass, which is its physical significance.

1.10 Conservation of Angular Momentum:

In the article 4.7 of XIth Std. we have seen the conservation of linear momentum which says that linear momentum of an isolated system is conserved in the absence of an external unbalanced force. As seen earlier, torque and angular momentum are the respective analogous quantities to force and linear momentum in rotational dynamics. With suitable changes this can be transformed into the conservation of angular momentum.

As seen in the section 1.8, angular momentum or the moment of linear momentum of a system is given by $\vec{L} = \vec{r} \times \vec{p}$

where \vec{r} is the position vector from the axis of rotation and \vec{p} is the linear momentum.

Differentiating with respect to time, we get,

$$\frac{d\vec{L}}{dt} = \frac{d}{dt}(\vec{r} \times \vec{p}) = \vec{r} \times \frac{d\vec{p}}{dt} + \frac{d\vec{r}}{dt} \times \vec{p}$$

$$\text{Now, } \frac{d\vec{r}}{dt} = \vec{v} \text{ and } \frac{d\vec{p}}{dt} = \vec{F}.$$

$$\therefore \frac{d\vec{L}}{dt} = \vec{r} \times \vec{F} + m(\vec{v} \times \vec{v})$$

$$\text{Now } (\vec{v} \times \vec{v}) = 0$$

$$\therefore \frac{d\vec{L}}{dt} = \vec{r} \times \vec{F}$$

But $\vec{r} \times \vec{F}$ is the moment of force or torque $\vec{\tau}$.

$$\therefore \vec{\tau} = \frac{d\vec{L}}{dt}$$

Thus, if $\vec{\tau} = 0$, $\frac{d\vec{L}}{dt} = 0$ or $\vec{L} = \text{constant}$.

Hence, angular momentum \vec{L} is conserved in the absence of external unbalanced torque $\vec{\tau}$.

This is the principle of conservation of angular momentum, analogous to the conservation of linear momentum.

Examples of conservation of angular momentum: During some shows of ballet dance, acrobat in a circus, sports like ice skating, diving in a swimming pool, etc., the principle of conservation of angular momentum is realized. In all these applications the product $L = I\omega = I(2\pi n)$ is constant (once the players acquire a certain speed). Thus, if the moment of inertia I is increased, the angular speed and hence the frequency of revolution n decreases. Also, if the moment of inertia is decreased, the frequency increases.

(i) Ballet dancers: During ice ballet, the dancers have to undertake rounds of smaller and larger radii. The dancers come together while taking the rounds of smaller radius (near the centre). In this case, the moment of inertia of their system becomes minimum and the frequency increases, to make it thrilling. While outer rounds, the dancers outstretch their legs and arms. This increases their moment of inertia that reduces the angular speed and hence the linear speed. This is essential to prevent slipping.

(ii) Diving in a swimming pool (during competition): While on the diving board, the divers stretch their body so as to increase the moment of inertia. Immediately after leaving the board, they fold their body. This reduces the moment inertia considerably. As a result, the frequency increases and they can complete more rounds in air to make the show attractive. Again, while entering into water they stretch their body into a streamline shape. This allows them a smooth entry into the water.

Example 1.8: A spherical water balloon is revolving at 60 rpm. In the course of time, 48.8 % of its water leaks out. With what frequency will the remaining balloon revolve now? Neglect all non-conservative forces.

Solution: $\frac{m_1}{m_2} = \frac{V_1}{V_2} = \left(\frac{R_1}{R_2}\right)^3 \therefore \frac{R_1}{R_2} = \left(\frac{m_1}{m_2}\right)^{\frac{1}{3}}$

$$\text{Also, } \frac{m_1}{m_2} = \frac{100}{100 - 48.8} = \frac{100}{51.2} = \frac{1}{0.512}$$

$$\therefore \left(\frac{m_1}{m_2}\right)^{\frac{1}{3}} = \frac{1}{0.8} = 1.25$$

$$n_1 = 60 \text{ rpm} = 1 \text{ rps, } \quad n_2 = ?$$

Being sphere, moment of inertia

$$I = \frac{2}{5} mR^2 \therefore \frac{I_1}{I_2} = \left(\frac{m_1}{m_2}\right) \left(\frac{R_1}{R_2}\right)^2 = \left(\frac{m_1}{m_2}\right)^{\frac{5}{3}}$$

According to principle of conservation of angular momentum, $I_1\omega_1 = I_2\omega_2$

$$\therefore I_1 2\pi n_1 = I_2 2\pi n_2 \therefore n_2 = \left(\frac{I_1}{I_2}\right) n_1 = \left(\frac{m_1}{m_2}\right)^{\frac{5}{3}}$$

$$n_2 = (1.25)^5 \times 1 = 3.052 \text{ rps}$$

Example 1.9: A ceiling fan having moment of inertia 2 kg-m^2 attains its maximum frequency of 60 rpm in '2π' seconds. Calculate its power rating.

Solution:

$$\omega_0 = 0, \quad \omega = 2\pi n = 2\pi \times 2 = 4\pi \text{ rad/s}$$

$$\alpha = \frac{\omega - \omega_0}{t} = \frac{4\pi - 0}{2\pi} = 2 \text{ rad/s}^2$$

$$\therefore P = \tau \cdot \omega = I\alpha \cdot \omega = 2 \times 2 \times 4\pi = 16\pi \text{ watt} \cong 50 \text{ watt}$$

1.11 Rolling Motion:

The objects like a cylinder, sphere, wheels, etc. are quite often seen to perform rolling motion. In the case of pure rolling, two motions are undertaken simultaneously; circular motion and linear motion. Individual motion of the particles (except the one at the centre of mass) is too difficult to describe. However, for theory considerations we can consider the actual motion to be the result of

- (i) circular motion of the body as a whole, about its own symmetric axis and
- (ii) linear motion of the body assuming it to be concentrated at its centre of mass. In other words, the centre of mass performs purely translational motion.

Accordingly, the object possesses two types of kinetic energies, rotational and translational. Sum of these two is its total kinetic energy.

Consider an object of moment of inertia I , rolling uniformly. Following quantities can be related.

v = Linear speed of the centre of mass

R = Radius of the body

ω = Angular speed of rotation of the body

$$\therefore \omega = \frac{v}{R} \text{ for any particle}$$

M = Mass of the body

K = Radius of gyration of the body $\therefore I = MK^2$

Total kinetic energy of rolling = Translational K.E. + Rotational K.E.

$$\begin{aligned} \therefore E &= \frac{1}{2} Mv^2 + \frac{1}{2} I\omega^2 \\ &= \frac{1}{2} Mv^2 + \frac{1}{2} (MK^2) \left(\frac{v}{R}\right)^2 \\ &= \frac{1}{2} Mv^2 \left(1 + \frac{K^2}{R^2}\right) \quad \text{--- (1.18)} \end{aligned}$$

It must be remembered that static friction is essential for a purely rolling motion. In this case, it prevents the sliding motion. You might have noticed that many a times while rolling down, the motion is initially a purely rolling motion that later on turns out to be a sliding motion. Similarly, if you push a sphere-like object along a horizontal surface, initially it slips for some distance and then starts rolling.

1.11.1 Linear Acceleration and Speed While Pure Rolling Down an Inclined Plane:

Figure 1.18 shows a rigid object of mass m and radius R , rolling down an inclined plane, without slipping. Inclination of the plane with the horizontal is θ .

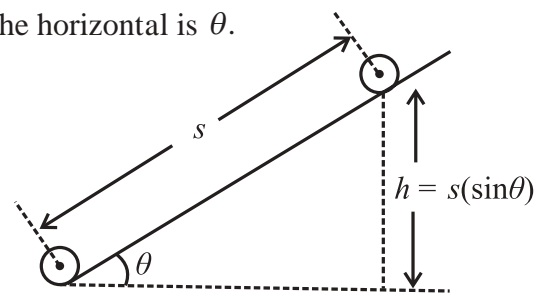

Fig. 1.18: Rolling along an incline.

As the object starts rolling down, its gravitational P.E. is converted into K.E. of rolling. Starting from rest, let v be the speed of the centre of mass as the object comes down through a vertical distance h .

From Eq. (1.18),

$$E = \frac{1}{2} Mv^2 + \frac{1}{2} I\omega^2 = \frac{1}{2} Mv^2 \left(1 + \frac{K^2}{R^2} \right)$$

$$\therefore E = mgh = \frac{1}{2} Mv^2 \left(1 + \frac{K^2}{R^2} \right)$$

$$\therefore v = \sqrt{\frac{2gh}{\left(1 + \frac{K^2}{R^2} \right)}} \quad \text{--- (1.19)}$$

Linear distance travelled along the plane is $s = \frac{h}{\sin \theta}$

During this distance, the linear velocity has increased from zero to v . If a is the linear acceleration along the plane,

$$2as = v^2 - u^2 \therefore 2a \left(\frac{h}{\sin \theta} \right) = \frac{2gh}{\left(1 + \frac{K^2}{R^2} \right)} - 0$$

$$\therefore a = \frac{g \sin \theta}{\left(1 + \frac{K^2}{R^2} \right)} \quad \text{--- (1.20)}$$

For pure sliding, without friction, the acceleration is $g \sin \theta$ and final velocity is $\sqrt{2gh}$. Thus, during pure rolling, the factor $\left(1 + \frac{K^2}{R^2} \right)$ is effective for both the expressions.

Remarks :

I) For a rolling object, if the expression for moment of inertia is of the form $n (MR^2)$, the numerical factor n gives the value of $\frac{K^2}{R^2}$ for that object.

For example, for a uniform solid sphere,
 $I = \frac{2}{5} MR^2 = MK^2 \therefore \frac{K^2}{R^2} = \frac{2}{5}$

Similarly,

$$\frac{K^2}{R^2} = 1, \text{ for a ring or a hollow cylinder}$$

$$\frac{K^2}{R^2} = \frac{1}{2} \text{ for a uniform disc or a solid cylinder}$$

$$\frac{K^2}{R^2} = \frac{2}{3} \text{ for a thin walled hollow sphere}$$

(II) When a rod rolls, it is actually a cylinder that is rolling.

(III) While rolling, the ratio 'Translational K.E.: Rotational K.E.: Total K.E.' is

$$1 : \frac{K^2}{R^2} : \left(1 + \frac{K^2}{R^2} \right)$$

For example, for a hollow sphere, $\frac{K^2}{R^2} = \frac{2}{3}$
 Thus, for a rolling hollow sphere,

Translational K.E.: Rotational K.E.: Total

$$\text{K.E.} = 1 : \frac{2}{3} : \left(1 + \frac{2}{3} \right) = 3 : 2 : 5$$

Percentage wise, 60% of its kinetic energy is translational and 40% is rotational.

Table 1 : Analogous kinematical equations
 (ω_0 is the initial angular velocity)

Equation for translational motion	Analogous equation for rotational motion
$v_{av} = \frac{u+v}{2}$	$\omega_{av} = \frac{\omega_0 + \omega}{2}$
$a = \frac{dv}{dt} = \frac{v-u}{t}$ $\therefore v = u + at$	$\alpha = \frac{d\omega}{dt} = \frac{\omega - \omega_0}{t}$ $\therefore \omega = \omega_0 + \alpha t$
$s = v_{av} \cdot t$ $= \left(\frac{u+v}{2} \right) t$ $= ut + \frac{1}{2} at^2$	$\theta = \omega_{av} \cdot t$ $= \left(\frac{\omega_0 + \omega}{2} \right) t$ $= \omega_0 t + \alpha t^2$
$v^2 = u^2 + 2as$	$\omega^2 = \omega_0^2 + 2\alpha\theta$



Internet my friend

- <http://hyperphysics.phy-astr.gsu.edu/hbase/mi.html>
- <https://issacphysics.org>
- <https://www.engineeringtoolbox.com>
- <https://opentextbc.ca/physicstextbook>

Table 2: Analogous quantities between translational motion and rotational motion:

Translational motion		Rotational motion		
Quantity	Symbol/ expression	Quantity	Symbol/ expression	Inter-relation, if possible
Linear displacement	\vec{s}	Angular displacement	$\vec{\theta}$	$\vec{s} = \vec{\theta} \times \vec{r}$
Linear velocity	$\vec{v} = \frac{d\vec{s}}{dt}$	Angular velocity	$\vec{\omega} = \frac{d\vec{\theta}}{dt}$	$\vec{v} = \vec{\omega} \times \vec{r}$
Linear acceleration	$\vec{a} = \frac{d\vec{v}}{dt}$	Angular acceleration	$\vec{\alpha} = \frac{d\vec{\omega}}{dt}$	$\vec{\alpha} = \vec{a} \times \vec{r}$
Inertia or mass	m	Rotational inertia or moment of inertia	I	$I = \int r^2 dm = \sum m_i r_i^2$
Linear momentum	$\vec{p} = m\vec{v}$	Angular momentum	$\vec{L} = I\vec{\omega}$	$\vec{L} = \vec{r} \times \vec{p}$
Force	$\vec{f} = \frac{d\vec{p}}{dt}$	Torque	$\vec{\tau} = \frac{d\vec{L}}{dt}$	$\vec{\tau} = \vec{r} \times \vec{f}$
Work	$W = \vec{f} \cdot \vec{s}$	Work	$W = \vec{\tau} \cdot \vec{\theta}$	-----
Power	$P = \frac{dW}{dt} = \vec{f} \cdot \vec{v}$	Power	$P = \frac{dW}{dt} = \vec{\tau} \cdot \vec{\omega}$	-----

Table 3: Expressions for moment of inertias for some symmetric objects:

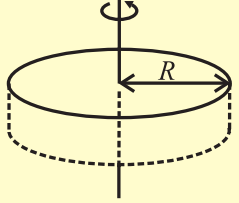
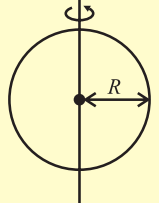
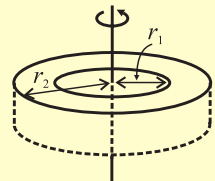
Object	Axis	Expression of moment of inertia	Figure
Thin ring or hollow cylinder	Central	$I = MR^2$	
Thin ring	Diameter	$I = \frac{1}{2} MR^2$	
Annular ring or thick walled hollow cylinder	Central	$I = \frac{1}{2} M (r_2^2 + r_1^2)$	

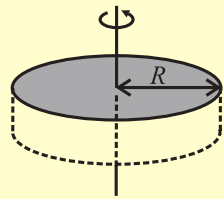
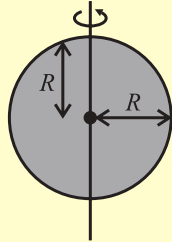
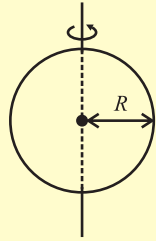
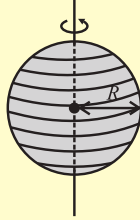
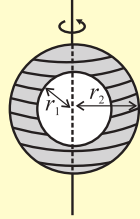
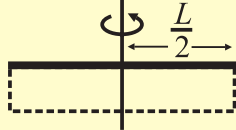
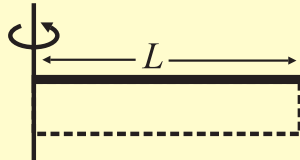
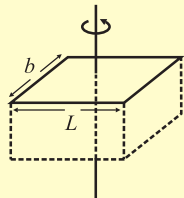
Uniform disc or solid cylinder	Central	$I = \frac{1}{2} MR^2$	
Uniform disc	Diameter	$I = \frac{1}{4} MR^2$	
Thin walled hollow sphere	Central	$I = \frac{2}{3} MR^2$	
Solid sphere	Central	$I = \frac{2}{5} MR^2$	
Uniform symmetric spherical shell	Central	$I = \frac{2}{5} M \frac{(r_2^5 - r_1^5)}{(r_2^3 - r_1^3)}$	
Thin uniform rod or rectangular plate	Perpendicular to length and passing through centre	$I = \frac{1}{12} ML^2$	
Thin uniform rod or rectangular plate	Perpendicular to length and about one end	$I = \frac{1}{3} ML^2$	
Uniform plate or rectangular parallelepiped	Central	$I = \frac{1}{12} M(L^2 + b^2)$	

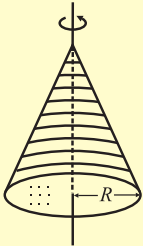
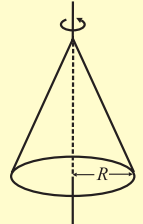
Uniform solid right circular cone	Central	$I = \frac{3}{10} MR^2$	
Uniform hollow right circular cone	Central	$I = \frac{1}{2} MR^2$	

**Exercises**

Use $g = 10 \text{ m/s}^2$, unless, otherwise stated.

1. Choose the correct option.

- i) When seen from below, the blades of a ceiling fan are seen to be revolving anticlockwise and their speed is decreasing. Select correct statement about the directions of its angular velocity and angular acceleration.
- (A) Angular velocity upwards, angular acceleration downwards.
 (B) Angular velocity downwards, angular acceleration upwards.
 (C) Both, angular velocity and angular acceleration, upwards.
 (D) Both, angular velocity and angular acceleration, downwards.
- ii) A particle of mass 1 kg, tied to a 1.2 m long string is whirled to perform vertical circular motion, under gravity. Minimum speed of a particle is 5 m/s. Consider following statements.
- P) Maximum speed must be $5\sqrt{5}$ m/s.
 Q) Difference between maximum and minimum tensions along the string is 60 N. Select correct option.
- (A) Only the statement P is correct.
 (B) Only the statement Q is correct.
 (C) Both the statements are correct.
 (D) Both the statements are incorrect.
- iii) Select correct statement about the

formula (expression) of moment of inertia (M.I.) in terms of mass M of the object and some of its distance parameter/s, such as R , L , etc.

- (A) Different objects must have different expressions for their M.I.
 (B) When rotating about their central axis, a hollow right circular cone and a disc have the same expression for the M.I.
 (C) Expression for the M.I. for a parallelepiped rotating about the transverse axis passing through its centre includes its depth.
 (D) Expression for M.I. of a rod and that of a plane sheet is the same about a transverse axis.
- iv) In a certain unit, the radius of gyration of a uniform disc about its central and transverse axis is $\sqrt{2.5}$. Its radius of gyration about a tangent in its plane (in the same unit) must be
- (A) $\sqrt{5}$ (B) 2.5
 (C) $2\sqrt{2.5}$ (D) $\sqrt{12.5}$
- v) Consider following cases:
- (P) A planet revolving in an elliptical orbit.
 (Q) A planet revolving in a circular orbit. Principle of conservation of angular momentum comes in force in which of these?

- (A) Only for (P)
 (B) Only for (Q)
 (C) For both, (P) and (Q)
 (D) Neither for (P), nor for (Q)
- X) A thin walled hollow cylinder is rolling down an incline, without slipping. At any instant, the ratio "Rotational K.E.: Translational K.E.: Total K.E." is
 (A) 1:1:2 (B) 1:2:3
 (C) 1:1:1 (D) 2:1:3

2. Answer in brief.

- Why are curved roads banked?
 - Do we need a banked road for a two-wheeler? Explain.
 - On what factors does the frequency of a conical pendulum depends? Is it independent of some factors?
 - Why is it useful to define radius of gyration?
 - A uniform disc and a hollow right circular cone have the same formula for their M.I., when rotating about their central axes. Why is it so?
- While driving along an unbanked circular road, a two-wheeler rider has to lean with the vertical. Why is it so? With what angle the rider has to lean? Derive the relevant expression. Why such a leaning is *not* necessary for a four wheeler?
 - Using the energy conservation, derive the expressions for the minimum speeds at different locations along a vertical circular motion controlled by gravity. Is zero speed possible at the uppermost point? Under what condition/s? Also prove that the difference between the extreme tensions (or normal forces) depends only upon the weight of the object.
 - Discuss the necessity of radius of gyration. Define it. On what factors does it depend and it does not depend? Can you locate some similarity between the centre of mass and radius of gyration?
- What can you infer if a uniform ring and a uniform disc have the same radius of gyration?
- State the conditions under which the theorems of parallel axes and perpendicular axes are applicable. State the respective mathematical expressions.
 - Derive an expression that relates angular momentum with the angular velocity of a rigid body.
 - Obtain an expression relating the torque with angular acceleration for a rigid body.
 - State and explain the principle of conservation of angular momentum. Use a suitable illustration. Do we use it in our daily life? When?
 - Discuss the interlink between translational, rotational and total kinetic energies of a rigid object that rolls without slipping.
 - A rigid object is rolling down an inclined plane. Derive expressions for the acceleration along the track and the speed after falling through a certain vertical distance.
 - Somehow, an ant is stuck to the rim of a bicycle wheel of diameter 1 m. While the bicycle is on a central stand, the wheel is set into rotation and it attains the frequency of 2 rev/s in 10 seconds, with uniform angular acceleration. Calculate (i) Number of revolutions completed by the ant in these 10 seconds. (ii) Time taken by it for first complete revolution and the last complete revolution.
 [Ans: 10 rev., $t_{\text{first}} = \sqrt{10}$ s, $t_{\text{last}} = 0.5132$ s]
 - Coefficient of static friction between a coin and a gramophone disc is 0.5. Radius of the disc is 8 cm. Initially the centre of the coin is π cm away from the centre of the disc. At what minimum frequency will it start slipping from

- there? By what factor will the answer change if the coin is almost at the rim? (use $g = \pi^2 \text{ m/s}^2$)
 [Ans: 2.5 rev/s, $n_2 = \frac{1}{2} n_1$]
14. Part of a racing track is to be designed for a curvature of 72 m. We are not recommending the vehicles to drive faster than 216 kmph. With what angle should the road be tilted? By what height will its outer edge be, with respect to the inner edge if the track is 10 m wide?
 [Ans: $\theta = \tan^{-1}(5) = 78.69^\circ, h = 9.8 \text{ m}$]
15. The road in the question 14 above is constructed as per the requirements. The coefficient of static friction between the tyres of a vehicle on this road is 0.8, will there be any lower speed limit? By how much can the upper speed limit exceed in this case?
 [Ans: $v_{\min} \cong 88 \text{ kmph}$, no upper limit as the road is banked for $\theta > 45^\circ$]
16. During a stunt, a cyclist (considered to be a particle) is undertaking horizontal circles inside a cylindrical well of radius 6.05 m. If the necessary friction coefficient is 0.5, how much minimum speed should the stunt artist maintain? Mass of the artist is 50 kg. If she/he increases the speed by 20%, how much will the force of friction be?
 [Ans: $v_{\min} = 11 \text{ m/s}$, $f_s = mg = 500 \text{ N}$]
17. A pendulum consisting of a massless string of length 20 cm and a tiny bob of mass 100 g is set up as a conical pendulum. Its bob now performs 75 rpm. Calculate kinetic energy and increase in the gravitational potential energy of the bob. (Use $\pi^2 = 10$)
 [Ans: $\cos \theta = 0.8$, K.E. = 0.45 J, $\Delta(\text{P.E.}) = 0.04 \text{ J}$]
18. A motorcyclist (as a particle) is undergoing vertical circles inside a sphere of death. The speed of the motorcycle varies between 6 m/s and 10 m/s. Calculate diameter of the sphere of death. How much minimum values are possible for these two speeds?
 [Ans: Diameter = 3.2 m, $(v_1)_{\min} = 4 \text{ m/s}$, $(v_2)_{\min} = 4\sqrt{5} \text{ m/s}$]
19. A metallic ring of mass 1 kg has moment of inertia 1 kg m^2 when rotating about one of its diameters. It is molten and remoulded into a thin uniform disc of the same radius. How much will its moment of inertia be, when rotated about its own axis.
 [Ans: 1 kg m^2]
20. A big dumb-bell is prepared by using a uniform rod of mass 60 g and length 20 cm. Two identical solid spheres of mass 50 g and radius 10 cm each are at the two ends of the rod. Calculate moment of inertia of the dumb-bell when rotated about an axis passing through its centre and perpendicular to the length.
 [Ans: 24000 g cm^2]
21. A flywheel used to prepare earthenware pots is set into rotation at 100 rpm. It is in the form of a disc of mass 10 kg and radius 0.4 m. A lump of clay (to be taken equivalent to a particle) of mass 1.6 kg falls on it and adheres to it at a certain distance x from the centre. Calculate x if the wheel now rotates at 80 rpm.
 [Ans: $x = \frac{1}{\sqrt{8}} \text{ m} = 0.35 \text{ m}$]
22. Starting from rest, an object rolls down along an incline that rises by 3 in every 5 (along it). The object gains a speed of $\sqrt{10} \text{ m/s}$ as it travels a distance of $\frac{5}{3} \text{ m}$ along the incline. What can be the possible shape/s of the object?
 [Ans: $\frac{K^2}{R^2} = 1$. Thus, a ring or a hollow cylinder]

2. Mechanical Properties of Fluids



Can you recall?

1. How important are fluids in our life?
2. What is atmospheric pressure?
3. Do you feel excess pressure while swimming under water? Why?

2.1 Introduction:

In XIth Std. we discussed the behaviour of solids under the action of a force. Among three states of matter, i.e., solid, liquid and gas, a solid nearly maintains its fixed shape and volume even if a large force is applied to it. Liquids and gases do not have their own shape and they take the shape of the containing vessel. Due to this, liquids and gases flow under the action of external force. A *fluid means a substance that can flow*. Therefore, liquids and gases, collectively, are called fluids. A fluid either has no rigidity or its rigidity is very low.

In our daily life, we often experience the pressure exerted by a fluid at rest and in motion. Viscosity and surface tension play an important role in nature. We will try to understand such properties in this chapter.

2.2 Fluid:

Any substance that can flow is a fluid. A fluid is a substance that deforms continually under the action of an external force. Fluid is a phase of matter that includes liquids, gases and plasmas.



Do you know?

Plasma is one of the four fundamental states of matter. It consists of a gas of ions, free electrons and neutral atoms.

We shall discuss mechanical properties of only liquids and gases in this Chapter. The shear modulus of a fluid is zero. In simpler words, fluids are substances which cannot resist any shear force applied to them. Air, water, flour dough, toothpaste, etc., are some common examples of fluids. Molten lava is also a fluid.

A fluid flows under the action of a force or a pressure gradient. Behaviour of a fluid in motion is normally complicated. We can understand fluids by making some simple assumptions. We introduce the concept of an ideal fluid to understand its behaviour. An *ideal fluid* has the following properties:

1. It is incompressible: its density is constant.
2. Its flow is irrotational: its flow is smooth, there are no turbulences in the flow.
3. It is nonviscous: there is no internal friction in the flow, i.e., the fluid has no viscosity. (viscosity is discussed in section 2.6.1)
4. Its flow is steady: its velocity at each point is constant in time.

It is important to understand the difference between a solid and a fluid. Solids can be subjected to shear stress (tangential stress) as shown in Fig. 2.1 and normal stress, as shown in Fig. 2.2.

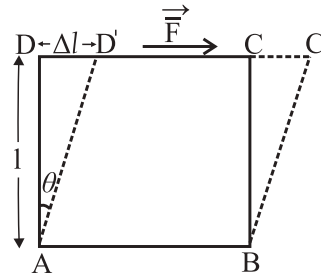

Fig. 2.1: Shear stress.

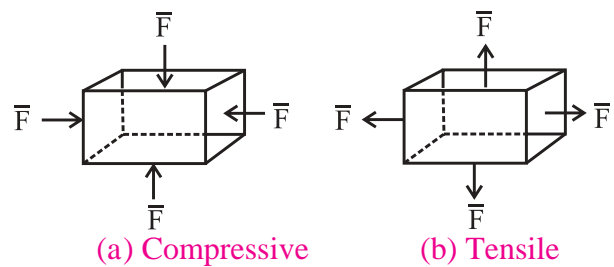

Fig. 2.2: Normal stress.

Solids oppose the shear stress either by developing a restoring force, which means that the deformations are reversible, or they require a certain initial stress before they deform and start flowing. (We have studied this behavior of solids (elastic behaviour) in XIth Std.)

Ideal fluids, on the other hand, can only be subjected to normal, compressive stress (called pressure). Most fluids offer a very

weak resistance to deformation. Real fluids display viscosity and so are capable of being subjected to low levels of shear stress.

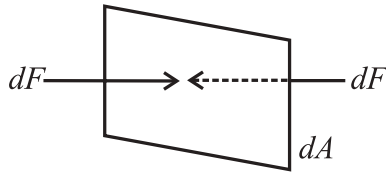

Fig. 2.3: Forces acting on a small surface dA within a fluid at rest.

The Fig. 2.3 shows a small surface of area dA at rest within a fluid. The surface does not accelerate, so the surrounding fluid exerts equal normal forces dF on both sides of it.

Properties of Fluids:

1. They do not oppose deformation, they get permanently deformed.
2. They have ability to flow.
3. They have ability to take the shape of the container.

A fluid exhibits these properties because it cannot oppose a shear stress when in static equilibrium.



Remember this

The term *fluid* includes both the liquid and gas phases. It is commonly used, as a synonym for *liquid* only, without any reference to gas. For example, ‘brake fluid’ is hydraulic oil and will not perform its required function if there is gas in it! This colloquial use of the term is also common in the fields of medicine and nutrition, e.g., “take plenty of fluids”.

2.2.1 Fluids at Rest:

The branch of physics which deals with the properties of fluids at rest is called *hydrostatics*. In the next few sections we will consider some of the properties of fluids at rest.

2.3 Pressure:

A fluid at rest exerts a force on the surface of contact. The surface may be a wall or the bottom of an open container of the fluid. The normal force (F) exerted by a fluid at rest per unit surface area (A) of contact is called the pressure (p) of the fluid.

$$p = \frac{F}{A} \quad \text{--- (2.1)}$$

Figure 2.4 shows a fluid exerting normal force on a vertical surface and Fig. 2.5 shows fluid exerting normal force on a horizontal surface.

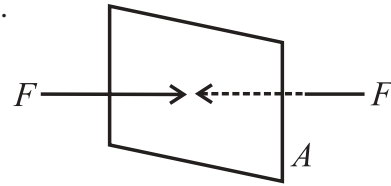

Fig. 2.4: Fluid exert force on vertical surface.

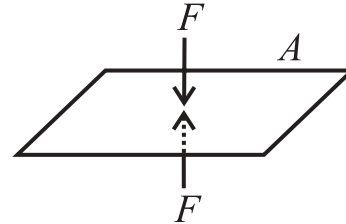

Fig. 2.5: Fluid exert force on horizontal surface.

Thus, an object having small weight can exert high pressure if its weight acts on a small surface area. For example, a force of 10 N acting on 1 cm² results in a pressure of 10⁵ N m⁻². On the other hand, the same force of 10 N while acting on an area of 1 m², exerts a pressure of only 10 N m⁻².



Remember this

1 N weight is about 100 g mass, if $g = 10 \text{ m s}^{-2}$.

The SI unit of pressure is N/m². Also, 1 N/m² = 1 Pascal (Pa). The dimension of pressure is [L⁻¹M⁻¹T⁻²]. *Pressure is a scalar quantity*. Other common units of measuring pressure of a gas are *bar* and *torr*.

1 bar = 10⁵ Nm⁻²

1 hectapascal (hPa) = 100 Pa



Can you tell?

Why does a knife have a sharp edge, and a needle has a sharp tip?



Use your brain power

A student of mass 50 kg is standing on both feet. Estimate the pressure exerted by the student on the Earth. Assume reasonable value to any other quantity you need. Justify your assumption. You may use $g = 10 \text{ m s}^{-2}$. By what factor will it change if the student lies on back?



Remember this

The concept of pressure is useful in dealing with fluids, i.e., liquids and gases. As fluids do not have definite shape and volume, it is convenient to use the quantities pressure and density rather than force and mass when studying hydrostatics and hydrodynamics.



Remember this

1. As $p = h\rho g$, the pressure exerted by a fluid at rest is independent of the shape and size of the container.
2. $p = h\rho g$ is true for liquids as well as for gases.

2.3.1 Pressure Due to a Liquid Column:

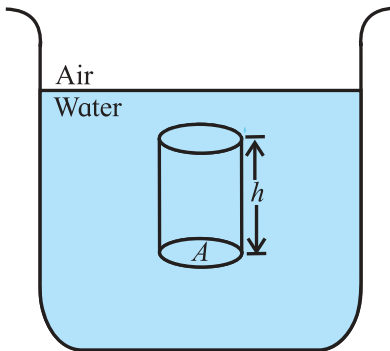

Fig. 2.6: Pressure due to a liquid column.

A vessel is filled with a liquid. Let us calculate the pressure exerted by an imaginary cylinder of cross sectional area A inside the container. Let the density of the fluid be ρ , and the height of the imaginary cylinder be h as shown in the Fig. 2.6. The liquid column exerts a force $F = mg$, which is its weight, on the bottom of the cylinder. This force acts in the downward direction. Therefore, the pressure p exerted by the liquid column on the bottom of cylinder is,

$$p = \frac{F}{A}$$

$$\therefore p = \frac{mg}{A}$$

Now, $m = (\text{volume of cylinder}) \times (\text{density of liquid})$

$$= (Ah) \times \rho = Ah\rho$$

$$\therefore p = \frac{(Ah\rho)g}{A}$$

$$p = h\rho g \quad \text{--- (2.2)}$$

Thus, the pressure p due to a liquid of density ρ at rest, and at a depth h below the free surface is $h\rho g$.

Note that the pressure does not depend on the area of the imaginary cylinder used to derive the expression.

Example 2.1: Two different liquids of density ρ_1 and ρ_2 exert the same pressure at a certain point. What will be the ratio of the heights of the respective liquid columns?

Solution: Let h_1 be the height of the liquid of density ρ_1 . Then the pressure exerted by the liquid of density ρ_1 is $p_1 = h_1\rho_1g$. Similarly, let h_2 be the height of the liquid of density ρ_2 . Then the pressure exerted by the liquid of density ρ_2 is $p_2 = h_2\rho_2g$.

Both liquids exert the same pressure, therefore we write,

$$p_1 = p_2$$

$$\therefore h_1\rho_1g = h_2\rho_2g \text{ or, } \frac{h_1}{h_2} = \frac{\rho_2}{\rho_1}$$

Alternate method:

For a given value of $p = h\rho g = \text{constant}$, as g is constant. So the height is inversely proportional to the density of the fluid ρ . In this case, since pressure is constant, height is inversely proportional to density of the liquid.

Example 2.2: A swimmer is swimming in a swimming pool at 6 m below the surface of the water. Calculate the pressure on the swimmer due to water above. (Density of water = 1000 kg/m^3 , $g = 9.8 \text{ m/s}^2$)

Solution: Given,

$$h = 6 \text{ m, } \rho = 1000 \text{ kg/m}^3, g = 9.8 \text{ m/s}^2$$

$$p = h\rho g = 6 \times 1000 \times 9.8 = 5.88 \times 10^5 \text{ N/m}^2$$

(Which is nearly 6 times the atmospheric pressure!)

2.3.2 Atmospheric Pressure:

Earth's atmosphere is made up of a fluid, namely, air. It exerts a downward force due to its weight. The pressure due to this force is called atmospheric pressure. Thus, at any point, the atmospheric pressure is the weight of a column of air of unit cross section starting

from that point and extending to the top of the atmosphere. Clearly, the atmospheric pressure is highest at the surface of the Earth, i.e., at the sea level, and decreases as we go above the surface as the height of the column of air above decreases. The atmospheric pressure at sea level is called *normal atmospheric pressure*. The density of air in the atmosphere decreases with increase in height and becomes negligible beyond a height of about 8 km so that the height of air column producing atmospheric pressure at sea level can be taken to be 8 km.

The region where gas pressure is less than the atmospheric pressure is called *vacuum*. Perfect or absolute vacuum is when no matter, i.e., no atoms or molecules are present. Usually, vacuum refers to conditions when the gas pressure is considerably smaller than the atmospheric pressure.

2.3.3 Absolute Pressure and Gauge Pressure:

Consider a tank filled with water as shown in Fig. 2.7. Assume an imaginary cylinder of horizontal base area A and height $x_1 - x_2 = h$. x_1 and x_2 being the heights measured from a reference point, height increasing upwards: $x_1 > x_2$. The vertical forces acting on the cylinder are:

1. Force \vec{F}_1 acts downwards at the top surface of the cylinder, and is due to the weight of the water column above the cylinder.
2. Force \vec{F}_2 acts upwards at the bottom surface of the cylinder, and is due to the water below the cylinder.
3. The gravitational force on the water enclosed in the cylinder is mg , where m is the mass of the water in the cylinder. As the water is in static equilibrium, the forces on the cylinder are balanced. The balance of these forces in magnitude is written as,

$$F_2 = F_1 + mg \quad \text{--- (2.3)}$$

p_1 and p_2 are the pressures at the top and bottom surfaces of the cylinder respectively due to the fluid. Using Eq. (2.1) we can write

$$F_1 = p_1 A, \text{ and } F_2 = p_2 A \quad \text{--- (2.4)}$$

Also, the mass m of the water in the cylinder can be written as,

$$m = \text{density} \times \text{volume} = \rho V$$

$$\therefore m = \rho A(x_1 - x_2) \quad \text{--- (2.5)}$$

Substituting Eq. (2.4) and Eq. (2.5) in Eq. (2.3) we get,

$$p_2 A = p_1 A + \rho A g (x_1 - x_2)$$

$$p_2 = p_1 + \rho g (x_1 - x_2) \quad \text{--- (2.6)}$$

This equation can be used to find the pressure inside a liquid (as a function of depth below the liquid surface) and also the atmospheric pressure (as a function of altitude or height above the sea level).

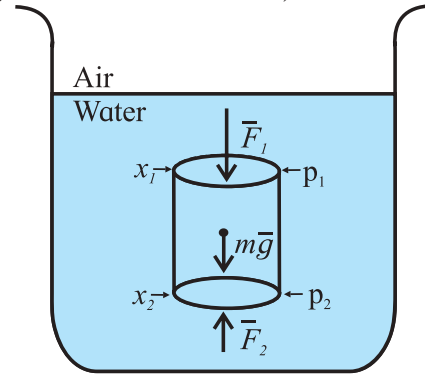

Fig. 2.7: Pressure due to an imaginary cylinder of fluid.

To find the pressure p at a depth h below the liquid surface, let the top of an imaginary cylinder be at the surface of the liquid. Let this level be x_1 . Let x_2 be some point at depth h below the surface as shown in Fig. 2.8. Let p_0 be the atmospheric pressure at the surface, i.e., at x_1 . Then, substituting $x_1 = 0$, $p_1 = p_0$, $x_2 = -h$, and $p_2 = p$ in Eq. (2.6) we get,

$$p = p_0 + h\rho g \quad \text{--- (2.7)}$$

The above equation gives the total pressure, or the *absolute pressure* p , at a depth h below the surface of the liquid. The total pressure p , at the depth h is the sum of:

1. p_0 , the pressure due to the atmosphere, which acts on the surface of the liquid, and
2. $h\rho g$, the pressure due to the liquid at depth h .

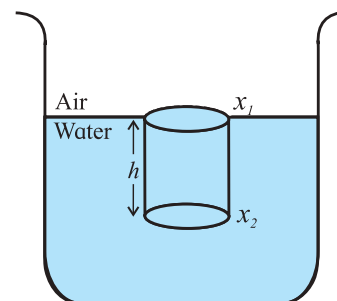

Fig. 2.8: Pressure at a depth h below the surface of a liquid.

In general, the difference between the absolute pressure and the atmospheric pressure is called the *gauge pressure*. Using Eq. (2.7), gauge pressure at depth h below the liquid surface can be written as,

$$p - p_0 = h\rho g \quad \text{--- (2.8)}$$

Eq. (2.8) is also applicable to levels above the liquid surface. It gives the pressure at a given height above a liquid surface, in terms of the atmospheric pressure p_0 (assuming that the atmospheric density is uniform up to that height).

To find the atmospheric pressure at a distance d above the liquid surface as shown in Fig. 2.9, we substitute $x_1 = d$, $p_1 = p$, $x_2 = 0$, $p_2 = p_0$ and $\rho = \rho_{\text{air}}$ in Eq. (2.6) we get,

$$p = p_0 - d\rho_{\text{air}}g \quad \text{--- (2.9)}$$

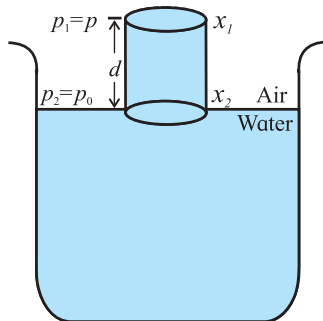
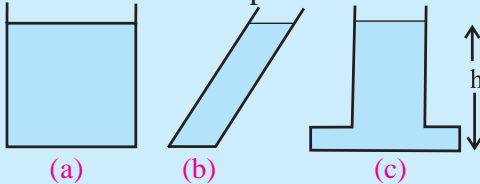

Fig. 2.9: Change of atmospheric pressure with height.



Can you tell?

The figures show three containers filled with the same oil. How will the pressures at the reference line compare?



2.3.4 Hydrostatic Paradox:

Consider the inter connected vessels as shown in Fig. 2.10 (a). When a liquid is poured in any one of the vessels, it is noticed that the level of liquids in all the vessels is the same. This observation is somewhat puzzling. It was called 'hydrostatics paradox' before the principle of hydrostatics were completely understood.

One can feel that the pressure of the base of the vessel C would be more than that at the

base of the vessel B and the liquid from vessel C would rise into the vessel B. However, it is never observed. Equation 2.2 tells that the pressure at a point depends only on the height of the liquid column above it. It does not depend on the shape of the vessel. In this case, height of the liquid column is the same for all the vessels. Therefore, the pressure of liquid column in each vessel is the same and the system is in equilibrium. That means the liquid in vessel C does not rise into vessel B.

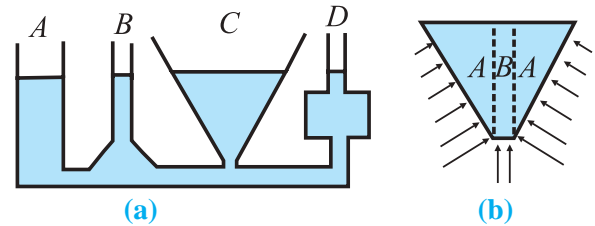

Fig. 2.10: Hydrostatic paradox.

Consider Fig. 2.10 (b). The arrows indicate the forces exerted against the liquid by the walls of the vessel. These forces are perpendicular to walls of the vessel at each point. These forces can be resolved into vertical and horizontal components. The vertical components act in the upward direction. Weight of the liquid in section B is not balanced and contributes the pressure at the base. Thus, it is no longer a paradox!

2.3.5 Pascal's Law:

Pascal's law states that the pressure applied at any point of an enclosed fluid at rest is transmitted equally and undiminished to every point of the fluid and also on the walls of the container, provided the effect of gravity is neglected.

Experimental proof of Pascal's principle.

Consider a vessel with four arms A, B, C, and D fitted with frictionless, water tight pistons and filled with incompressible fluid as shown in the figure given. Let the area of cross sections of A, B, C, and D be a , $2a$, $3a$, and $a/2$ respectively. If a force F is applied on the piston A, the pressure exerted on the liquid is $p = F/a$. It is observed that the other three pistons B, C, and D move outward. In order to keep these three pistons B, C,

and D in their original positions, forces $2F$, $3F$, and $F/2$ respectively are required to be applied on the pistons. Therefore, pressure on the pistons B, C, and D is:

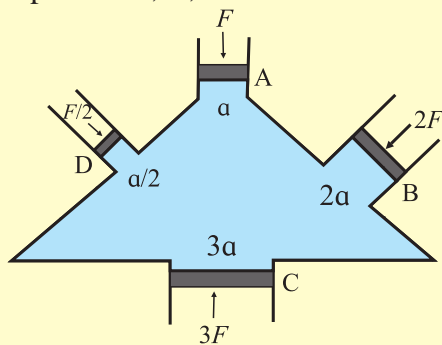

on B, $p_B = \frac{2F}{2a} = \frac{F}{a}$

on C, $p_C = \frac{3F}{3a} = \frac{F}{a}$ and

on D, $p_D = \frac{F/2}{a/2} = \frac{F}{a}$

i.e. $p_B = p_C = p_D = p$, this indicates that the pressure applied on piston A is transmitted equally and undiminished to all parts of the fluid and the walls of the vessel.

Applications of Pascal's Law:

i) Hydraulic lift: Hydraulic lift is used to lift a heavy object using a small force. The working of this machine is based on Pascal's law.

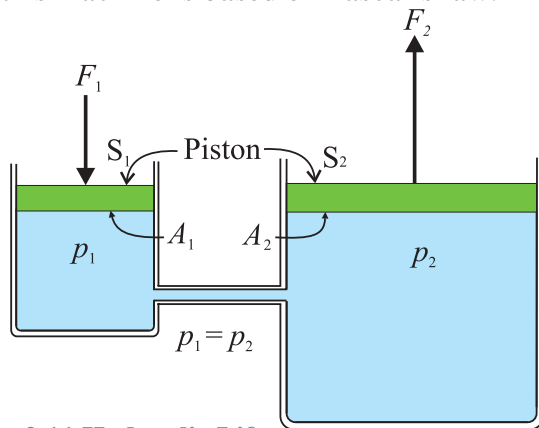

Fig. 2.11 Hydraulic Lift.

As shown in Fig. 2.11, a tank containing a fluid is fitted with two pistons S_1 and S_2 . S_1 has a smaller area of cross section, A_1 while S_2 has a much larger area of cross section, A_2 ($A_2 \gg A_1$). If we apply a force F_1 on the smaller piston S_1 in the downward direction it will generate pressure $p = (F_1/A_1)$ which will be

transmitted undiminished to the bigger piston S_2 . A force $F_2 = pA_2$ will be exerted upwards on it.

$$F_2 = F_1 \left(\frac{A_2}{A_1} \right) \quad \text{--- (2.10)}$$

Thus, F_2 is much larger than F_1 . A heavy load can be placed on S_2 and can be lifted up or moved down by applying a small force on S_1 . This is the principle of a hydraulic lift.



Observe and discuss

Blow air in to a flat balloon using a cycle pump. Discuss how Pascal's principle is applicable here.

ii) Hydraulic brakes: Hydraulic brakes are used to slow down or stop vehicles in motion. It is based on the same principle as that of a hydraulic lift.

Figure 2.12 shows schematic diagram of a hydraulic brake system. By pressing the brake pedal, the piston of the master cylinder is pushed in forward direction. As a result, the piston in the slave cylinder which has a much larger area of cross section as compared to that of the master cylinder, also moves in forward direction so as to maintain the volume of the oil constant. The slave piston pushes the friction pads against the rotating disc, which is connected to the wheel. Thus, causing a moving vehicle to slow down or stop.

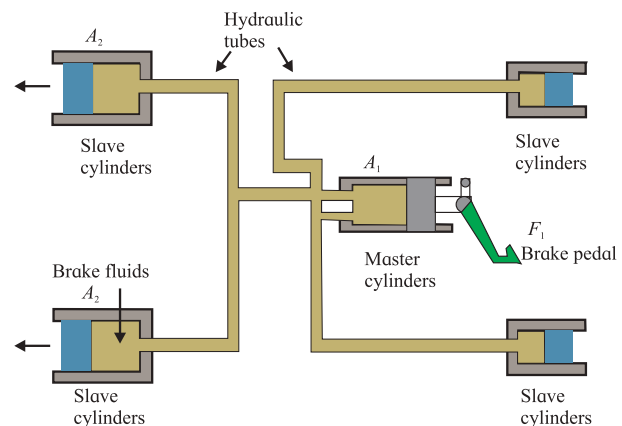

Fig. 2.12 Hydraulic brake system (schematic).

The master cylinder has a smaller area of cross section A_1 compared to the area A_2 of the slave cylinder. By applying a small force F_1

to the master cylinder, we generate pressure $p = (F_1/A_1)$. This pressure is transmitted undiminished throughout the system. The force F_2 on slave cylinder is then,

$$F_2 = pA_2 = \frac{F_1}{A_1} \times A_2 = F_1 \left(\frac{A_2}{A_1} \right)$$

This is similar to the principle used in hydraulic lift. Since area A_2 is greater than A_1 , F_2 is also greater than F_1 . Thus, a small force applied on the brake pedal gets converted into large force and slows down or stops a moving vehicle.

Example 2.3: A hydraulic brake system of a car of mass 1000 kg having speed of 50 km/h, has a cylindrical piston of radius of 0.5 cm. The slave cylinder has a radius of 2.5 cm. If a constant force of 100 N is applied on the brake pedal what distance the car will travel before coming to stop?

Solution: Given,

$$F_1 = 100 \text{ N}, A_1 = \pi (0.5 \times 10^{-2})^2 \text{ m}^2,$$

$$A_2 = \pi (2.5 \times 10^{-2})^2 \text{ m}^2, F_2 = ?$$

By Pascal's Principle,

$$\frac{F_2}{A_2} = \frac{F_1}{A_1}$$

$$F_2 = \frac{100 \times \pi (2.5 \times 10^{-2})^2}{\pi (0.5 \times 10^{-2})^2} = 2500 \text{ N}$$

Acceleration of the car =

$$a = F_2 / m = 2500/1000 = 2.5 \text{ m/s}^2. \text{ Using Newton's equation of motion,}$$

$$v^2 = u^2 - 2as \text{ where final velocity } v = 0, u = 50 \text{ km/h}$$

$$s = \left(\frac{50 \times 1000}{3600} \right)^2 \times \frac{1}{(2 \times 2.5)} = 38.58 \text{ m}$$

2.3.6 Measurement of Pressure:

Instruments used to measure pressure are called pressure meters or pressure gauges or vacuum gauges. Below we will describe two instruments which are commonly used to measure pressure.

Caution:

Use of mercury is not advised in a laboratory because mercury vapours are hazardous for life and for environment.

i) Mercury Barometer: An instrument that measures atmospheric pressure is called a *barometer*. One of the first barometers was by Italian scientist Torricelli. The barometer is in the form of a glass tube completely filled with mercury and placed upside down in a small dish containing mercury. Its schematic diagram is shown in Fig. 2.13.

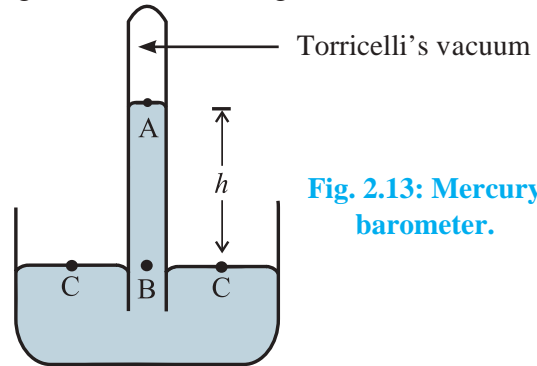

Fig. 2.13: Mercury barometer.

1. A glass tube of about 1 meter length and a diameter of about 1 cm is filled with mercury up to its brim. It is then quickly inverted into a small dish containing mercury. The level of mercury in the glass tube lowers as some mercury spills in the dish. A gap is created between the surface of mercury in the glass tube and the closed end of the glass tube. The gap does not contain any air and it is called *Torricelli's vacuum*. It does not contain some mercury vapors.
2. Thus, the pressure at the upper end of the mercury column inside the tube is zero, i.e. pressure at point such as A is $p_A = \text{zero}$.
3. Let us consider a point C on the mercury surface in the dish and another point B inside the tube at the same horizontal level as that of the point C.
4. The pressure at C is equal to the atmospheric pressure p_0 because it is open to atmosphere. As points B and C are at the same horizontal level, the pressure at B is also equal to the atmospheric pressure p_0 , i.e. $p_B = p_0$.
5. Suppose the point B is at a depth h below the point A and ρ is the density of mercury then,

$$P_B = P_A + h\rho g \quad \text{--- (2.11)}$$

$p_A = 0$ (there is vacuum above point A) and $p_B = p_0$, therefore, $p_0 = h\rho g$, where h is the length of mercury column in the mercury barometer.



Remember this

The atmospheric pressure is generally expressed as the length of mercury column in a mercury barometer.

$$p_{\text{atm}} = 76 \text{ cm of Hg} = 760 \text{ mm of Hg}$$

Another unit for measuring pressure is torr. One torr = 1 mm of Hg



Can you tell?

What will be the normal atmospheric pressure in bar and also in torr?

ii) Open tube manometer: A manometer consists of a U-shaped tube partly filled with a low density liquid such as water or kerosene. This helps in having a larger level difference between the level of liquid in the two arms of the manometer. Figure 2.14 shows an open tube manometer. One arm of the manometer is open to the atmosphere and the other is connected to the container D of which the pressure p is to be measured.

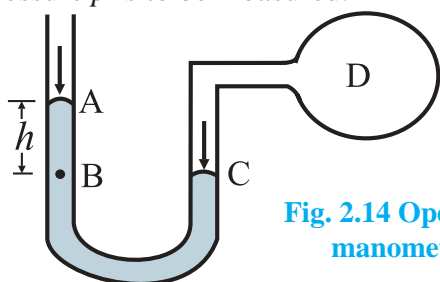

Fig. 2.14 Open tube manometer.

The pressure at point A is atmospheric pressure p_0 because this arm is open to atmosphere. To find the pressure at point C, which is exposed to the pressure of the gas in the container, we consider a point B in the open arm of the manometer at the same level as point C. The pressure at the points B and C is the same, i.e.,

$$p_C = p_B \quad \text{--- (2.12)}$$

The pressure at point B is,

$$p_B = p_0 + h\rho g \quad \text{--- (2.13)}$$

where, ρ is the density of the liquid in the manometer, h is the height of the liquid column above point B, and g is the acceleration due to gravity. According to Pascal's principle,

pressure at C is the same as at D, i.e., inside the chamber. Therefore, the pressure p in the container is,

$$p = p_C$$

Using Eq. (2.12) and Eq. (2.13) we can write,

$$p = p_0 + h\rho g \quad \text{--- (2.14)}$$

As the manometer measures the gauge pressure of the gas in the container D, we can write the gauge pressure in the container D as

$$p - p_0 = h\rho g$$



Can you recall?

1. You must have blown soap bubbles in your childhood. What is their shape?
2. Why does a greased razor blade float on the surface of water?
3. Why can a water spider walk comfortably on the surface of still water?
4. Why are free liquid drops and bubbles always spherical in shape?

2.4 Surface Tension:

A liquid at rest shows a very interesting property called *surface tension*. We have seen that water spider walks on the surface of steady water, greased needle floats on the steady surface of water, rain drops and soap bubbles always take spherical shape, etc. All these phenomena arise due to surface tension. Surface tension is one of the important properties of liquids.



Do you know?

1. When we write on paper, the ink sticks to the paper.
2. When teacher writes on a board, chalk particles stick to the board.
3. Mercury in a glass container does not wet its surface, while water in a glass container wets it.

2.4.1 Molecular Theory of Surface Tension:

All the above observations can be explained on the basis of different types of forces coming into play in all these situations. We will try to understand the effect of these forces and their relation to the surface tension in liquids.

To understand surface tension, we need to know some terms in molecular theory that explain the behaviour of liquids at their surface.

a) Intermolecular force: Matter is made up of molecules. Any two molecules attract each other. *This force between molecules is called intermolecular force.* There are two types of intermolecular forces - i) Cohesive force and ii) Adhesive force.

i) Cohesive force: The force of attraction between the molecules of the same substance is called cohesive force or force of cohesion. The force of attraction between two air molecules or that between two water molecules is a cohesive force. Cohesive force is strongest in solids and weakest in gases. This is the reason why solids have a definite shape and gases do not. Small droplets of liquid coalesce into one and form a drop due to this force.

ii) Adhesive force: The force of attraction between the molecules of different substances is called adhesive force or force of adhesion. The force of attraction between glass and water molecule is a force of adhesion.

b) Range of molecular force: The maximum distance from a molecule up to which the molecular force is effective is called the range of molecular force. Intermolecular forces are effective up to a distance of the order of few nanometer (10^{-9} m) in solids and liquids. Therefore, they are short range forces.

c) Sphere of influence: An imaginary sphere with a molecule at its center and radius equal to the molecular range is called the sphere of influence of the molecule. The spheres around molecules A, B or C are shown in Fig. 2.15 (a) and (b). *The intermolecular force is effective only within the sphere of influence.*

d) Surface film: The surface layer of a liquid with thickness equal to the range of intermolecular force is called the surface film. This is the layer shown between XY and X'Y' in Fig. 2.15 (b).

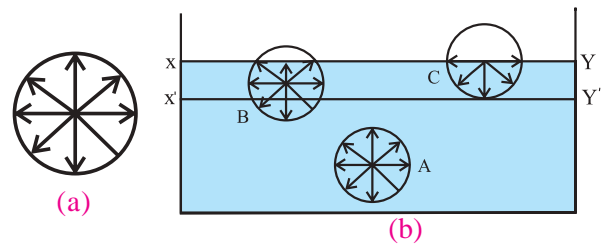

Fig. 2.15: (a) sphere of influence and (b) surface film.

(e) Free surface of a liquid: It is the surface of a fluid which does not experience any shear stress. For example, the interface between liquid water and the air above. In Fig. 2.15 (b), XY is the free surface of the liquid.



Remember this

While studying pressure, we considered both liquids and gases. But as gases do not have a free surface, they do not exhibit surface tension.

(f) Surface tension on the basis of molecular theory: As shown in Fig. 2.15 (b), XY is the free surface of liquid and X'Y' is the inner layer parallel to XY at distance equal to the range of molecular force. Hence, the section XX'-Y'Y near the surface of the liquid acts as the surface film. Consider three molecules A, B, and C such that molecule A is deep inside the liquid, molecule B within surface film and molecule C on the surface of the liquid.

As molecule A is deep inside the liquid, its sphere of influence is also completely inside the liquid. As a result, molecule A is acted upon by equal cohesive forces in all directions. *Thus, the net cohesive force acting on molecule A is zero.*

Molecule B lies within the surface layer and below the free surface of the liquid. A larger part of its sphere of influence is inside the liquid and a smaller part is in air. Due to this, a strong downward cohesive force acts on the liquid molecule. The adhesive force acting on molecule B due to air molecules above it and within its sphere of influence is weak. It points upwards. As a result, the molecule B gets attracted inside the liquid.

The same holds for molecule C which lies exactly on the free surface of the liquid. Half of the sphere of influence is in air and half in the liquid. The number of air molecules within the sphere of influence of the molecule C, above the free surface of the liquid is much less than the number of liquid molecules within the sphere of influence that lies within the liquid. This is because, the density of air is less than that of a liquid. The adhesive force trying to pull the molecule above the liquid surface is much weaker than the cohesive force that tries to pull the molecule inside the liquid surface. As a result, the molecule C also gets attracted inside the liquid.

Thus, all molecules in the surface film are acted upon by an unbalanced net cohesive force directed into the liquid. Therefore, the molecules in the surface film are pulled inside the liquid. This minimizes the total number of molecules in the surface film. As a result, the surface film remains under tension. The surface film of a liquid behaves like a stretched elastic membrane. This tension is known as surface tension. *The force due to surface tension acts tangential to the free surface of a liquid.*

2.4.2 Surface Tension and Surface Energy:

a) Surface Tension: As seen previously, the free surface of a liquid in a container acts as a stretched membrane and all molecules on the surface film experience a stretching force. Imagine a line PQ of length L drawn tangential to the free surface of the liquid, as shown in Fig. 2.16.

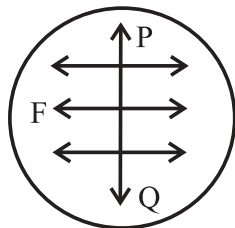

Fig. 2.16: Force of surface tension.

All the molecules on this line experience equal and opposite forces tangential to surface as if they are tearing the surface apart due to the cohesive forces of molecules lying on either side.

This force per unit length is the surface tension. *Surface tension T is defined as, the tangential force acting per unit length on both sides of an imaginary line drawn on the free surface of liquid.*

$$T = \frac{F}{L} \quad \text{--- (2.15)}$$

SI unit of surface tension is N/m. Its Dimension are, $[L^0M^1T^{-2}]$.



Use your brain power

Prove that, equivalent S.I. unit of surface tension is J/m^2 .

Example 2.4: A beaker of radius 10 cm is filled with water. Calculate the force of surface tension on any diametrical line on its surface. Surface tension of water is 0.075 N/m.

Solution: Given,

$$L = 2 \times 10 = 20 \text{ cm} = 0.2 \text{ m}$$

$$T = 0.075 \text{ N/m}$$

We have,

$$T = \frac{F}{L}$$

$$\begin{aligned} \therefore F &= TL = 0.075 \times 0.2 = 0.015 \\ &= 1.5 \times 10^{-2} \text{ N} \end{aligned}$$

Table 2.1 – Surface tension of some liquids at 20°C.

Sr. No.	Liquid	S.T. (N/m)	S.T. (dyne/cm)
1	Water	0.0727	72.7
2	Mercury	0.4355	435.5
3	Soap solution	0.025	25
4	Glycerin	0.0632	63.2

b) Surface Energy: We have seen that a molecule inside the volume of a liquid (like molecule A in Fig 2.15) experiences more cohesive force than a molecule like molecules B and C in the surface film of the liquid in that figure. Thus, work has to be done to bring any molecule from inside the liquid into the surface film. Clearly, the surface molecules possess extra potential energy as compared to the molecules inside the liquid. The extra

energy of the molecules in the surface layer is called the *surface energy* of the liquid. As any system always tries to attain a state of minimum potential energy, the liquid tries to reduce the area of its surface film. Energy has to be spent in order to increase the surface area of a liquid.



Remember this

- 1) Molecules on the liquid surface experience net inward pull. In spite of this if they remain at the surface, they possess higher potential energy. As a universal property, any system tries to minimize its potential energy. Hence liquid surface tries to minimize its surface area.
- 2) When a number of droplets coalesce and form a drop, there is reduction in the total surface area. In this case, energy is released to the surrounding.

c) Relation between the surface energy and surface tension: Consider a rectangular frame of wire P'PSS'. It is fitted with a movable arm QR as shown in Fig. 2.17. This frame is dipped in a soap solution and then taken out. A film of soap solution will be formed within the boundaries PQRS of the frame.

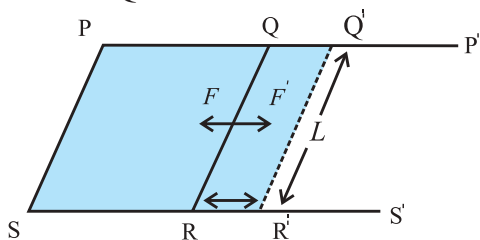

Fig. 2.17: Surface energy of a liquid

Each arm of the frame experiences an inward force due to the film. Under the action of this force, the movable arm QR moves towards side PS so as to decrease the area of the film. If the length of QR is L , then this inward force F acting on it is given by

$$F = (T) \times (2L) \quad \text{--- (2.16)}$$

Since the film has two surfaces, the upper surface and the lower surface, the total length over which surface tension acts on QR is $2L$. Imagine an external force F' (equal and

opposite to F) applied isothermally (gradually and at constant temperature), to the arm QR, so that it pulls the arm away and tries to increase the surface area of the film. The arm QR moves to Q'R' through a distance dx . Therefore, the work done against F , the force due to surface tension, is given by

$$dw = F'dx$$

Using Eq. (2.16),

$$dw = T(2Ldx)$$

But, $2Ldx = dA$, increase in area of the two surfaces of the film. Therefore, $dw = T(dA)$.

This work done in stretching the film is stored in the area dA of the film as its potential energy. *This energy is called surface energy.*

$$\therefore \text{Surface energy} = T(dA) \quad \text{--- (2.17)}$$

Thus, surface tension is also equal to the surface energy per unit area.

Example 2.5: Calculate the work done in blowing a soap bubble to a radius of 1 cm. The surface tension of soap solution is 2.5×10^{-2} N/m.

Solution: Given

$$T = 2.5 \times 10^{-2} \text{ N/m}$$

Initial radius of bubble = 0 cm

Final radius of bubble, $r = 1 \text{ cm} = 0.01 \text{ m}$

Initial surface area of soap bubble = 0

(A soap bubble has two surfaces, outer surface and inner surface).

Final surface area of soap bubble is,

$$A = 2 \times (4\pi r^2) = 8\pi r^2$$

$$\therefore \text{change in area} = dA = A - 0 = 8\pi r^2 = 0.00251 \text{ m}^2$$

$$\begin{aligned} \therefore \text{work done} &= T \times dA \\ &= 2.5 \times 10^{-2} \times 0.00251 \times 10^2 \\ &= 6.275 \times 10^{-5} \text{ J} \end{aligned}$$



Try this

Take a ring of about 5 cm in diameter. Tie a thin thread along the diameter of the ring. Keep the thread slightly loose. Dip the ring in a soap solution and take it out. A soap film is formed on either side of thread. Break the film on any one side of the thread. Discuss the result.

**Remember this**

The work done, under isothermal condition, against the force of surface tension to change the surface area of a liquid is stored as surface energy of liquid.

2.4.3 Angle of Contact:

When a liquid surface comes in contact with a solid surface, it forms a meniscus, which can be either convex (mercury-glass) or concave (water glass), as shown in Fig. 2.18. The angle of contact, θ , between a liquid and a solid surface is defined as the angle between the tangents drawn to the free surface of the liquid and surface of the solid at the point of contact, measured within the liquid.

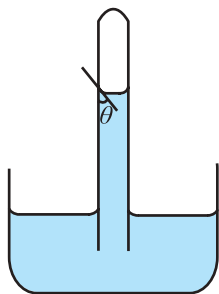

Fig. 2.18 (a): Concave meniscus due to liquids which partially wet a solid surface.

When the angle of contact is acute, the liquid forms a concave meniscus Fig. 2.18 (a) at the point of contact. When the angle of contact is obtuse, it forms a convex meniscus Fig. 2.18 (b). For example, water-glass interface forms a concave meniscus and mercury-glass interface forms a convex meniscus.

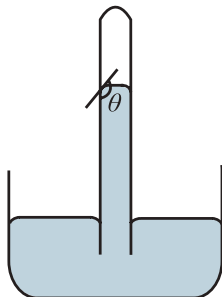

Fig. 2.18 (b): Convex meniscus due to liquids which do not wet a solid surface.

This difference between the shapes of menisci is due to the net effect of the cohesive forces between liquid molecules and adhesive forces between liquid and solid molecules as discussed below.

**Do you know?**

- when we observe the level of water in a capillary, we note down the level of the tangent to the meniscus inside the water.
- When we observe the level of mercury in a capillary we note down the level of the tangent to the meniscus above the mercury column.

a) Shape of meniscus:**i) Concave meniscus - acute angle of contact:**

Fig. 2.19 (a): Acute angle of contact.

Figure 2.19 (a) shows the acute angle of contact between a liquid surface (e.g., kerosene in a glass bottle). Consider a molecule such as A on the surface of the liquid near the wall of the container. The molecule experiences both cohesive as well as adhesive forces. In this case, since the wall is vertical, the net adhesive force (\overline{AP}) acting on the molecule A is horizontal, Net cohesive force (\overline{AC}) acting on molecule is directed at nearly 45° to either of the surfaces. Magnitude of adhesive force is so large that the net force (\overline{AR}) is directed inside the solid.

For equilibrium or stability of a liquid surface, the net force (\overline{AR}) acting on the molecule A must be normal to the liquid surface at all points. For the resultant force \overline{AR} to be normal to the tangent, the liquid near the wall should pile up against the solid boundary so that the tangent AT to the liquid surface is perpendicular to AR. Thus, this makes the meniscus concave. Obviously, such liquid wets that solid surface.

ii) Convex meniscus - obtuse angle of contact:

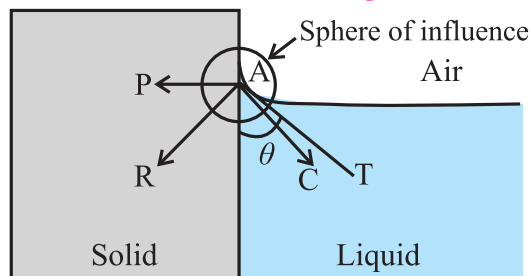
Figure 2.19 (b) shows the obtuse angle of contact between a liquid and a solid (e.g., mercury in a glass bottle). Consider a molecule such as A on the surface of the liquid

near the wall of the container. The molecule experiences both cohesive as well as adhesive forces. In this case also, the net adhesive force (\overline{AP}) acting on the molecule A is horizontal since the wall is vertical. Magnitude of cohesive force is so large that the net force (\overline{AR}) is directed inside the liquid.

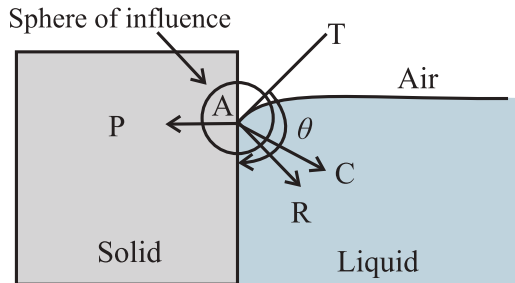

Fig. 2.19 (b): Obtuse angle of contact.

For equilibrium or stability of a liquid surface, the net force (\overline{AR}) acting on all molecules similar to molecule A must be normal to the liquid surface at all points. The liquid near the wall should, therefore, creep inside against the solid boundary. This makes the meniscus convex so that its tangent AT is normal to AR. Obviously, such liquid does not wet that solid surface.

iii) Zero angle of contact :

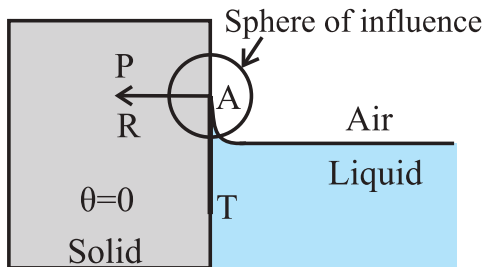

Fig. 2.19 (c): Angle of contact equal to zero.

Figure 2.19 (c) shows the angle of contact between a liquid (e.g. highly pure water) which completely wets a solid (e.g. clean glass) surface. The angle of contact in this case is almost zero (i.e., $\theta \rightarrow 0^\circ$). In this case, the liquid molecules near the contact region, are so less in number that the cohesive force is negligible, i.e., $\overline{AC} = 0$ and the net adhesive force itself is the resultant force, i.e., $\overline{AP} = \overline{AR}$. Therefore, the tangent AT is along the wall within the liquid and the angle of contact is zero.

iv) Angle of contact 90° and conditions for convexity and concavity:

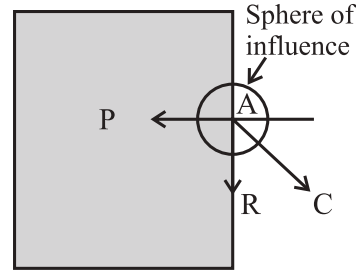

Fig. 2.19 (d): Acute angle equal to 90° .

Consider a hypothetical liquid having angle of contact 90° with a given solid container, as shown in the Fig. 2.19 (d). In this case, the net cohesive force \overline{AC} is exactly at 45° with either of the surfaces and the resultant force \overline{AR} is exactly vertical (along the solid surface).

For this to occur, $\overline{AP} = \frac{AC}{\sqrt{2}}$ where, AR is the magnitude of the net force. From this we can write the conditions for acute and obtuse angles of contact:

For acute angle of contact, $\overline{AP} > \frac{AC}{\sqrt{2}}$, and for obtuse angle of contact, $\overline{AP} < \frac{AC}{\sqrt{2}}$.

Can you tell?
How does a water proofing agent work?

b) Shape of liquid drops on a solid surface:

When a small amount of a liquid is dropped on a plane solid surface, the liquid will either spread on the surface or will form droplets on the surface. Which phenomenon will occur depends on the surface tension of the liquid and the angle of contact between the liquid and the solid surface. The surface tension between the liquid and air as well as that between solid and air will also have to be taken in to account.

Let θ be the angle of contact for the given solid-liquid pair.

T_1 = Force due to surface tension at the liquid-solid interface,

T_2 = Force due to surface tension at the air-solid interface,

T_3 = Force due to surface tension at the air-liquid interface.

As the force due to surface tension is tangential to the surfaces in contact, directions of T_1 , T_2 and T_3 are as shown in the Fig. 2.20. For equilibrium of the drop,

$$T_2 = T_1 + T_3 \cos \theta, \cos \theta = \frac{T_2 - T_1}{T_3} \quad \text{--- (2.18)}$$

From this equation we get the following cases:

- 1) If $T_2 > T_1$ and $(T_2 - T_1) < T_3$, $\cos \theta$ is positive and the angle of contact θ is acute as shown in Fig. 2.20 (a).

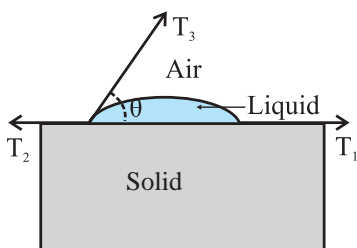

Fig. 2.20 (a): Acute angle.

- 2) If $T_2 < T_1$ and $(T_1 - T_2) < T_3$, $\cos \theta$ is negative, and the angle of contact θ is obtuse as shown in Fig. 2.20(b).

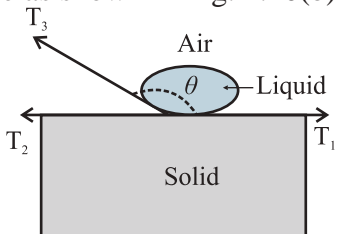

Fig. 2.20 (b): Obtuse angle.

- 3) If $(T_2 - T_1) = T_3$, $\cos \theta = 1$ and θ is nearly equal to zero.
- 4) If $(T_2 - T_1) > T_3$ or $T_2 > (T_1 + T_3)$, $\cos \theta > 1$ which is impossible. The liquid spreads over the solid surface and drop will not be formed.

c) Factors affecting the angle of contact:

The value of the angle of contact depends on the following factors,

- i) The nature of the liquid and the solid in contact.
- ii) Impurity : Impurities present in the liquid change the angle of contact.
- iii) Temperature of the liquid : Any increase in the temperature of a liquid decreases its angle of contact. *For a given solid-liquid surface, the angle of contact is constant at a given temperature.*

Table 2.2 – Angle of contact for pair of liquid - solid in contact.

Sr. No.	Liquid - solid in contact	Angle of contact
1	Pure water and clean glass	0°
2	Chloroform with clean glass	0°
3	Organic liquids with clean glass	0°
4	Ether with clean glass	16°
5	Kerosene with clean glass	26°
6	Water with paraffin	107°
7	Mercury with clean glass	140°

2.4.4 Effect of impurity and temperature on surface tension:

a) Effect of impurities:

- i) When soluble substance such as common salt (i.e., sodium chloride) is dissolved in water, the surface tension of water increases.
- ii) When a sparingly soluble substance such as phenol or a detergent is mixed with water, surface tension of water decreases. For example, a detergent powder is mixed with water to wash clothes. Due to this, the surface tension of water decreases and water makes good contact with the fabric and is able to remove tough stains.
- iii) When insoluble impurity is added into water, surface tension of water decreases. When impurity gets added to any liquid, the cohesive force of that liquid decreases which affects the angle of contact and hence the shape of the meniscus. If mercury gathers dust then its surface tension is reduced. It does not form spherical droplets unless the dust is completely removed.

b) Effect of temperature: In most liquids, as temperature increases surface tension decreases. For example, it is suggested that new cotton fabric should be washed in cold water. In this case, water does not make good contact with the fabric due to its higher surface tension. The fabric does not lose its colour because of this.

Hot water is used to remove tough stains on fabric because of its lower surface tension.

In the case of molten copper or molten cadmium, the surface tension increases with increase in its temperature.

The surface tension of a liquid becomes zero at critical temperature.

2.4.5 Excess pressure across the free surface of a liquid:

Every molecule on a liquid surface experiences forces due to surface tension which are tangential to the liquid surface at rest. The direction of the resultant force of surface tension acting on a molecule on the liquid surface depends upon the shape of that liquid surface. This force also contributes in deciding the pressure at a point just below the surface of a liquid.

Figures 2.21 (a), (b) and (c) show surfaces of three liquids with different shapes and their menisci. Let \vec{f}_A be the downward force due to the atmospheric pressure. All the three figures show two molecules A and B. The molecule A is just above, and the molecule B is just below it (inside the liquid). Level difference between A and B is almost zero, so that it does not contribute anything to the pressure difference. In all the three figures, the pressure at the point A is the atmospheric pressure p .

a) Plane liquid surface:

Figure 2.21 (a) shows planar free surface of the liquid. In this case, the resultant force due to surface tension, \vec{f}_T on the molecule at B is zero. The force \vec{f}_A itself decides the pressure and the pressure at A and B is the same.

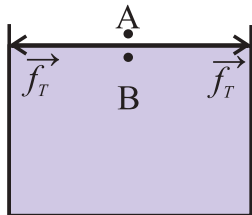

Fig. 2.21 (a): Plane surface.

b) Convex liquid surface:

Surface of the liquid in the Fig.2.21 (b) is upper convex. (Convex, when seen from above). In this case, the resultant force due to surface tension, \vec{f}_T on the molecule at B is vertically downwards and adds up to the

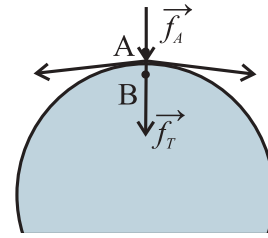

Fig. 2.21 (b) : Convex surface.

downward force \vec{f}_A . This develops greater pressure at point B, which is inside the liquid and on the concave side of the meniscus. Thus, the pressure on the concave side i.e., inside the liquid is greater than that on the convex side i.e., outside the liquid.

c) Concave liquid surface:

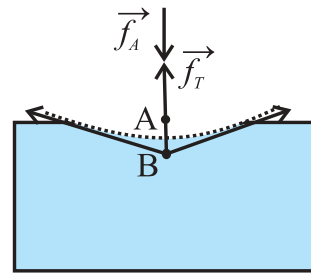

Fig. 2.21 (c): Concave Surface.

Surface of the liquid in the Fig. 2.21 (c) is upper concave (concave, when seen from above). In this case, the force due to surface tension \vec{f}_T , on the molecule at B is vertically upwards. The force \vec{f}_A due to atmospheric pressure acts downwards. Forces \vec{f}_A and \vec{f}_T thus, act in opposite direction. Therefore, the net downward force responsible for the pressure at B is less than \vec{f}_A . This develops a lesser pressure at point B, which is inside the liquid and on the convex side of the meniscus. Thus, the pressure on the concave side i.e., outside the liquid, is greater than that on the convex side, i.e., inside the liquid.

2.4.6 Explanation of formation of drops and bubbles:

Liquid drops and small bubbles are spherical in shape because the forces of surface tension dominate the gravitational force. These force always try to minimize the surface area of the liquid. A bubble or drop does not collapse because the resultant of the external pressure and the force of surface tension is smaller than the pressure inside a bubble or inside a liquid drop.

Consider a spherical drop as shown in Fig. 2.22. Let p_i be the pressure inside the drop and p_o be the pressure outside it. As the drop is spherical in shape, the pressure, p_i , inside the drop is greater than p_o , the pressure outside. Therefore, the excess pressure inside the drop is $p_i - p_o$.

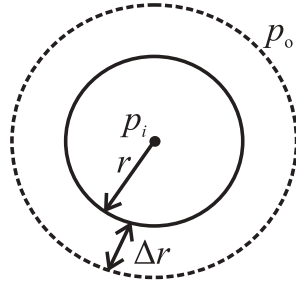

Fig. 2.22. Excess pressure inside a liquid drop.

Let the radius of the drop increase from r to $r + \Delta r$, where Δr is very small, so that the pressure inside the drop remains almost constant.

Let the initial surface area of the drop be $A_1 = 4\pi r^2$, and the final surface area of the drop be $A_2 = 4\pi (r + \Delta r)^2$.

$$\therefore A_2 = 4\pi(r^2 + 2r\Delta r + \Delta r^2)$$

$$\therefore A_2 = 4\pi r^2 + 8\pi r\Delta r + 4\pi\Delta r^2$$

As Δr is very small, Δr^2 can be neglected,

$$\therefore A_2 = 4\pi r^2 + 8\pi r\Delta r$$

Thus, increase in the surface area of the drop is

$$dA = A_2 - A_1 = 8\pi r\Delta r \quad \text{--- (2.19)}$$

Work done in increasing the surface area by dA is stored as excess surface energy.

$$\therefore dW = TdA = T(8\pi r\Delta r) \quad \text{--- (2.20)}$$

This work done is also equal to the product of the force F which causes increase in the area of the bubble and the displacement Δr which is the increase in the radius of the bubble.

$$\therefore dW = F\Delta r \quad \text{--- (2.21)}$$

The excess force is given by,

(Excess pressure) \times (Surface area)

$$\therefore F = (p_i - p_o) 4\pi r^2 \quad \text{--- (2.22)}$$

Equating Eq. (2.20) and Eq. (2.21), we get,

$$T(8\pi r\Delta r) = (p_i - p_o) 4\pi r^2\Delta r$$

$$\therefore (p_i - p_o) = \frac{2T}{r} \quad \text{--- (2.23)}$$

This equation gives the excess pressure inside a drop. This is called Laplace's law of a spherical membrane.

In case of a soap bubble there are two free surfaces in contact with air, the inner

surface and the outer surface. For a bubble, Eq. (2.19) changes to $dA = 2(8\pi r\Delta r)$. Hence, total increase in the surface area of a soap bubble, while increasing its radius by Δr , is $2(8\pi r\Delta r)$

The work done by this excess pressure is

$$dW = (p_i - p_o) 4\pi r^2\Delta r = T(16\pi r\Delta r)$$

$$\therefore (p_i - p_o) = \frac{4T}{r} \quad \text{--- (2.24)}$$



Remember this

The gravitational force acting on a molecule, which is its weight, is also one of the forces acting within the sphere of influence near the contact region. However, within the sphere of influence, the cohesive and adhesive forces are so strong that the gravitational force can be neglected in the above explanation.

Brain teaser:

1. Can you suggest any method to measure the surface tension of a soap solution? Will this method have any commercial application?
2. What happens to surface tension under different gravity (e.g. Space station or lunar surface)?

Example 2.6: What should be the diameter of a water drop so that the excess pressure inside it is 80 N/m^2 ? (Surface tension of water = $7.27 \times 10^{-2} \text{ N/m}$)

Solution: Given

$$p_i - p_o = 80 \text{ N/m}^2$$

$$T = 7.27 \times 10^{-2} \text{ N/m}$$

We have,

$$(p_i - p_o) = \frac{2T}{r}$$

$$\therefore r = \frac{2T}{p_i - p_o} = \frac{2 \times 7.27 \times 10^{-2}}{80} = 1.8 \times 10^{-3} \text{ m}$$

$$\therefore d = 2r = 3.6 \text{ mm}$$

2.4.7 Capillary Action:

A tube having a very fine bore ($\sim 1 \text{ mm}$) and open at both ends is called a capillary tube. If one end of a capillary tube is dipped in a liquid which partially or completely wets the surface of the capillary (like water in glass) the level of liquid in the capillary rises. On the

other hand, if the capillary tube is dipped in a liquid which does not wet its surface (like mercury in glass) the level of liquid in the capillary drops.

The phenomenon of rise or fall of a liquid inside a capillary tube when it is dipped in the liquid is called *capillarity*. Capillarity is in action when,

- Oil rises up the wick of a lamp.
- Cloth rag sucks water.
- Water rises up the crevices in rocks.
- Sap and water rise up to the top most leaves in a tree.
- Blotting paper absorbs ink.

When a capillary is dipped in a liquid, two effects can be observed, a) The liquid level can rise in the capillary (water in a glass capillary), or b) The liquid level can fall in the capillary (mercury in glass capillary). Here we discuss a qualitative argument to explain the capillary fall.

a) Capillary fall:

Consider a capillary tube dipped in a liquid which does not wet the surface, for example, in mercury. The shape of mercury meniscus in the capillary is upper convex. Consider the points A, B, C, and D such that, (see Fig. 2.23 (a)).

- Point A is just above the convex surface and inside the capillary.
- Point B is just below the convex surface inside the capillary.
- Point C is just above the plane surface outside the capillary.
- Point D is just below the plane surface and outside the capillary, and below the point C.

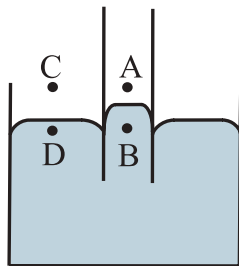

Fig. 2.23 (a) : Capillary in mercury before drop in level.

Let p_A , p_B , p_C , and p_D be the values of the pressures at the points A, B, C, and D respectively. As discussed previously, the pressure on the concave side is always greater

than that on the convex side.

$$\therefore p_B > p_A$$

As the points A and C are at the same level, the pressure at both these points is the same, and it is the atmospheric pressure.

$$\therefore p_A = p_C \quad \text{--- (2.25)}$$

Between the points C and D, the surface is plane.

$$\therefore p_C = p_D = p_A \quad \text{--- (2.26)}$$

$\therefore p_B > p_D$. But the points B and D are at the same horizontal level. Thus, in order to maintain the same pressure, the mercury in the capillary rushes out of the capillary. Because of this, there is a drop in the level of mercury inside the capillary as shown in Fig. 2.23 (b).

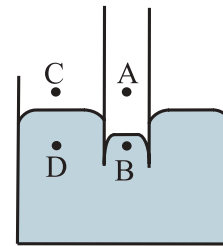

Fig. 2.23 (b) : Capillary in mercury, drop in level.

b) Capillary rise:

Refer to Fig. 2.24 (a) and Fig. 2.24 (b) and explain the rise of a liquid inside a capillary.

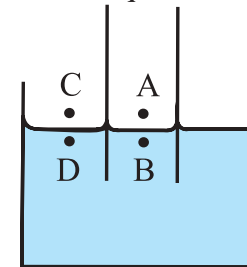

Fig. 2.24 (a) : Capillary just immersed in water.

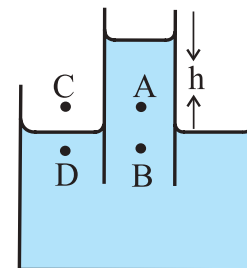

Fig. 2.24 (b) : Capillary in water after rise in level.

Expression for capillary rise or fall:

Method (I): Using pressure difference

The pressure due to the liquid (water) column of height h must be equal to the pressure difference $2T/R$ due to the concavity.

$$\therefore h\rho g = \frac{2T}{R} \quad \text{--- (2.27)}$$

where, ρ is the density of the liquid and g is acceleration due to gravity.

Let r be the radius of the capillary tube and θ be the angle of contact of the liquid as shown in Fig. 2.25 (a).



Fig. 2.25 (a): Forces acting at the point of contact.

Then radius of curvature R of the meniscus is given by $R = \frac{r}{\cos\theta}$

$$\begin{aligned} \therefore h\rho g &= \frac{2T\cos\theta}{r} \\ \therefore h &= \frac{2T\cos\theta}{r\rho g} \quad \text{--- (2.28)} \end{aligned}$$

The above equation gives the expression for capillary rise (or fall) for a liquid. Narrower the tube, the greater is the height to which the liquid rises (or falls).

If the capillary tube is held vertical in a liquid that has a convex meniscus, then the angle of contact θ is obtuse. Therefore, $\cos\theta$ is negative and so is h . This means that the liquid will suffer capillary fall or depression.

b) (Method II): Using forces:

Rise of water inside a capillary is against gravity. Hence, weight of the liquid column must be equal and opposite to the proper component of force due to surface tension at the point of contact.

The length of liquid in contact inside the

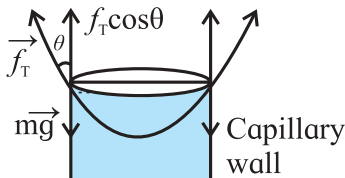

Fig 2.25 (b): Forces acting on liquid inside a capillary.

capillary is the circumference $2\pi r$. Thus, the force due to surface tension is given by, $f_T = (\text{surface tension}) \times (\text{length in contact}) = T \times 2\pi r$

Direction of this force is along the tangent, as shown in the Fig. 2.25 (b).

Vertical component of this force is

$$(f_T)_v = T \times 2\pi r \times \cos\theta \quad \text{--- (2.29)}$$

Ignoring the liquid in the concave meniscus, the volume of the liquid in the capillary rise is $V = \pi r^2 h$.

\therefore Mass of the liquid in the capillary rise,

$$m = \pi r^2 h \rho$$

\therefore Weight of the liquid in the capillary (rise or fall), $w = \pi r^2 h \rho g$ --- (2.30)

This must be equal and opposite to the vertical component of the force due to surface tension. Thus, equating right sides of equations (2.29) and (2.30), we get,

$$\pi r^2 h \rho g = T \times 2\pi r \times \cos\theta$$

$$\therefore h = \frac{2T\cos\theta}{r\rho g}$$

In terms of capillary rise, the expression for surface tension is,

$$T = \frac{r h \rho g}{2 \cos\theta} \quad \text{--- (2.31)}$$

The same expression is also valid for capillary fall discussed earlier.

Example 2.7: A capillary tube of radius 5×10^{-4} m is immersed in a beaker filled with mercury. The mercury level inside the tube is found to be 8×10^{-3} m below the level of reservoir. Determine the angle of contact between mercury and glass. Surface tension of mercury is 0.465 N/m and its density is 13.6×10^3 kg/m³. ($g = 9.8$ m/s²)

Solution: Given,

- $r = 5 \times 10^{-4}$ m
- $h = -8 \times 10^{-3}$ m
- $T = 0.465$ N/m
- $g = 9.8$ m/s²
- $\rho = 13.6 \times 10^3$ kg/m³

we have,

$$T = \frac{h r \rho g}{2 \cos\theta}$$

$$\therefore 0.465$$

$$= \frac{-8 \times 10^{-3} \times 5 \times 10^{-4} \times 13.6 \times 10^3 \times 9.8}{2 \cos\theta}$$

$$\therefore \cos\theta = \frac{-40 \times 9.8 \times 13.6 \times 10^{-4}}{2 \times 0.465}$$

$$\therefore -\cos\theta = 0.5732$$

$$\therefore \cos(\pi - \theta) = 0.5732$$

$$\therefore 180^\circ - \theta = 55^\circ 2'$$

$$\therefore \theta = 124^\circ 58'$$

**Do you know?**

Einstein's first ever published scientific article deals with capillary action? Published in German in 1901, it was entitled *Folegerungen aus den capillaritatserscheinungen* (conclusions drawn from the phenomena of capillarity).

2.5 Fluids in Motion:

We come across moving fluids in our day to day life. The flow of water through our taps, the flow of cooking gas through tubes, or the flow of water through a river or a canal can be understood using the concepts developed in this section.

The branch of Physics which deals with the study of properties of fluids in motion is called *hydrodynamics*. As the study of motion of real fluid is very complicated, we shall limit our study to the motion of an ideal fluid. We have discussed an ideal fluid in the beginning of this Chapter. Study of a fluid in motion is very important.

Consider Fig. 2.26 which shows a pipe whose direction and cross sectional area change arbitrarily. The direction of flow of the fluid in pipe is as shown. We assume an ideal fluid to flow through the pipe. We define a few terms used to describe flow of a fluid.

Steady flow: Measurable property, such as pressure or velocity of the fluid at a given point is constant over time.

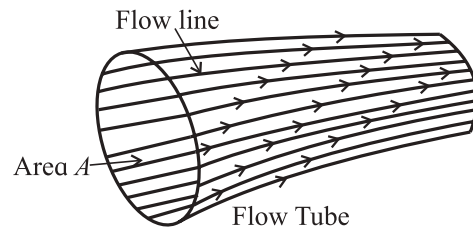
**Fig. 2.26: Flow lines and flow tube.**

Flow line: It is the path of an individual particle in a moving fluid as shown in Fig. 2.26.

Streamline: It is a curve whose tangent at any point in the flow is in the direction of the velocity of the flow at that point. *Streamlines and flow lines are identical for a steady flow.*

Flow tube: It is an imaginary bundle of flow lines bound by an imaginary wall. For a steady flow, the fluid cannot cross the walls of a flow tube. *Fluids in adjacent flow tubes cannot mix.*

Laminar flow/Streamline flow: It is a steady flow in which adjacent layers of a fluid move smoothly over each other as shown in Fig. 2.27 (a). A steady flow of river can be assumed to be a laminar flow.

Turbulent flow: It is a flow at a very high flow rate so that there is no steady flow and the flow pattern changes continuously as shown in Fig. 2.27 (b). A flooded river flow or a tap running very fast is a turbulent flow.

Table 2.3 Streamline Flow and Turbulent Flow

Streamline flow	Turbulent flow
1) The smooth flow of a fluid, with velocity smaller than certain critical velocity (limiting value of velocity) is called streamline flow or laminar flow of a fluid.	1) The irregular and unsteady flow of a fluid when its velocity increases beyond critical velocity is called turbulent flow.
2) In a streamline flow, velocity of a fluid at a given point is always constant.	2) In a turbulent flow, the velocity of a fluid at any point does not remain constant.
3) Two streamlines can never intersect, i.e., they are always parallel.	3) In a turbulent flow, at some points, the fluid may have rotational motion which gives rise to eddies.
4) Streamline flow over a plane surface can be assumed to be divided into a number of plane layers. In a flow of liquid through a pipe of uniform cross sectional area, all the streamlines will be parallel to the axis of the tube.	4) A flow tube loses its order and particles move in random direction.

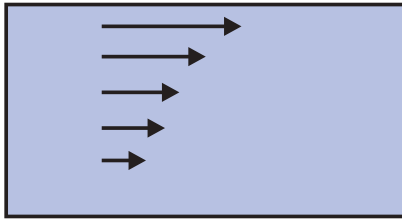

Fig. 2.27 (a): Streamline flow.

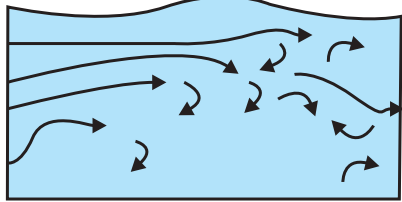

Fig. 2.27 (b): Turbulent flow.

**Can you tell?**

What would happen if two streamlines intersect?

**Activity**

Identify some examples of streamline flow and turbulent flow in every day life. How would you explain them? When would you prefer a stream line flow?

2.6 Critical Velocity and Reynolds number:

The flow of a fluid, whether streamline or turbulent, is differentiated on the basis of velocity of the flow. The velocity beyond which a streamline flow becomes turbulent is called *critical velocity*.

According to Osborne Reynolds (1842 - 1912), critical velocity is given by

$$v_c = \frac{R_n \eta}{\rho d}, \quad \text{--- (2.32)}$$

where,

v_c = critical velocity of the fluid

R_n = Reynolds number

η = coefficient of viscosity

ρ = density of fluid

d = diameter of tube

From Eq. (2.32) equation for Reynolds number can be written as,

$$R_n = \frac{v_c \rho d}{\eta} \quad \text{--- (2.33)}$$

Reynolds number is a pure number. It has no unit and dimensions. It is found that for R_n

less than 1000, the flow of a fluid is streamline while for R_n greater than 2000, the flow of fluid is turbulent. When R_n is between 1000 and 2000, the flow of fluid becomes unsteady, i.e., it changes from a streamline flow to a turbulent flow.

2.6.1 Viscosity:

When we pour water from a glass, it flows freely and quickly. But when we pour syrup or honey, it flows slowly and sticks to the container. The difference is due to fluid friction. This friction is both within the fluid itself and between the fluid and its surroundings. This property of fluids is called *viscosity*. Water has low viscosity, whereas syrup or honey has high viscosity. Figure 2.28 shows a schematic section of viscous flow and Fig. 2.29 that of a non viscous flow. Note that there is no dragging force in the non-viscous flow, and all layers are moving with the same velocity.

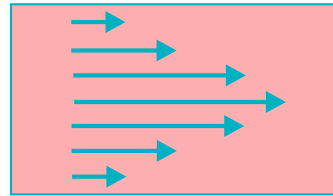

Fig. 2.28: Viscous flow. Different layers flow with different velocities. The central layer flows the fastest and the outermost layers flow the slowest.

Viscosity of such fluid is zero. The only fluid that is almost non-viscous is liquid helium at about 2K. In this section, we will study viscosity of a fluid and how it affects the flow of a fluid.

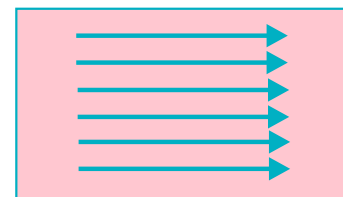

Fig. 2.29: Non-viscous flow. Different layers flow with the same velocity.

If we observe the flow of river water, it is found that the water near both sides of the river bank flows slow and as we move towards the center of the river, the water flows faster gradually. At the centre, the flow is the fastest. From this observation it is clear that there is some opposing force between two adjacent layers of fluids which affects their relative motion.

Viscosity is that property of fluid, by virtue of which, the relative motion between different layers of a fluid experience a dragging force. This force is called the viscous drag. This is shown schematically in Fig. 2.30.

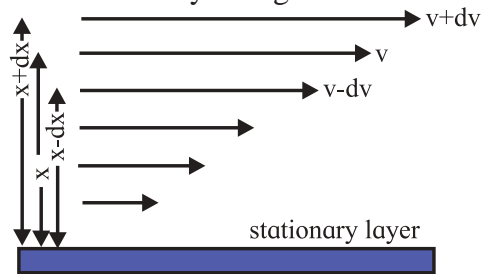

Fig. 2.30: Change in velocity of layer as its distance from a referee layer changes.

In liquids, the viscous drag is due to short range molecular cohesive forces, and in gases it is due to collisions between fast moving molecules. In both liquids and gases, as long as the relative velocity between the layers is small, the viscous drag is proportional to the relative velocity. However, in a turbulent flow, the viscous drag increases rapidly and is not proportional to relative velocity but proportional to higher powers of relative velocity.

Velocity gradient: The rate of change of velocity (dv) with distance (dx) measured from a stationary layer is called velocity gradient (dv/dx).

2.6.2 Coefficient of viscosity:

According to Newton’s law of viscosity, for a streamline flow, viscous force (f) acting on any layer is directly proportional to the area (A) of the layer and the velocity gradient (dv/dx) i.e.,

$$f \propto A \left(\frac{dv}{dx} \right)$$

$$\therefore f = \eta A \left(\frac{dv}{dx} \right) \quad \text{--- (2.34)}$$

where η is a constant, called coefficient of viscosity of the liquid. From Eq. (2.34) we can write,

$$\eta = \frac{f}{A \left(\frac{dv}{dx} \right)} \quad \text{--- (2.35)}$$

Note: ‘ A ’ in this expression is not the cross sectional area, it is the area of the layer, parallel to the direction of the flow.

The coefficient of viscosity can be defined as the viscous force per unit area per unit velocity gradient. S.I. unit of viscosity is Ns/m^2 .



Use your brain power

CGS unit of viscosity is Poise. Find the relation between Poise and the SI unit of viscosity.

A Microscopic View of Viscosity:

Viscosity of a fluid can be explained on the basic of molecular motion as follow. Consider the laminar flow between plates X and Y as shown in the figure. Plate X is stationary and plate Y moves with a velocity v_0 . Layers a, b, and c move with velocity, $v-dv$, v , and $v + dv$ respectively. Consider two adjacent layers, b and c. The velocity of the fluid is equal to mean velocity of the molecules contained in that layer. Thus, the mean velocity of the molecules in layer b is v , while the molecules in layers c have a slightly greater mean velocity $v + dv$. As you will learn in the next chapter, each molecule possesses a random velocity whose magnitude is usually larger than that of the mean velocity. As a result, molecules are continually transferred in large numbers between the two layers. On the average, molecules passing from layer

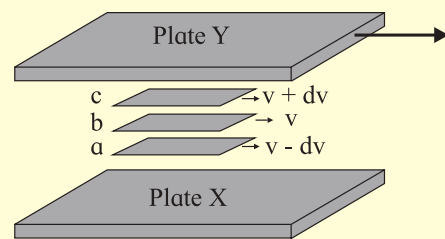

c to layer b will be moving too fast for their 'new' layer by an amount dv and will slow down as a result of collisions with the molecules in layer b. The result is a transfer of momentum from faster-moving layers c to their neighboring slower-moving layers such as b and thus eventually to plate X. Because the original source of this transfer of momentum is plate Y, the overall result is a transfer of momentum from plate Y

to plate X. If there are no external forces applied, this momentum transfer would reduce speed of the plate Y to zero with respect to the plate X.

Reduction in the velocity of the molecules in the direction of laminar flow is due to the fact that their directions after collision are random. This randomness, to be discussed in Chapter 3, results in an increase in the thermal energy of the fluid at the cost of its macroscopic kinetic energy. *That is, the process is dissipative, or frictional.*

In liquids there is an additional, stronger interaction between molecules in adjacent layers, due to the intermolecular forces that distinguish liquid from gases. As a result, there is a transfer of momentum from faster-moving layers to slower-moving layers, which results in a viscous drag.



Remember this

Coefficient of viscosity of a fluid changes with change in its temperature. For most liquids, the coefficient of viscosity decreases with increase in their temperature. It probably depends on the fact that at higher temperatures, the molecules are farther apart and the cohesive forces or inter-molecular forces are, therefore, less effective. Whereas, in gases, the coefficient of viscosity increases with the increase in temperature. This is because, at high temperatures, the molecules move faster and collide more often with each other, giving rise to increased internal friction.

Table 2.4 Coefficient of viscosity at different temperatures.

Fluid	Temperature	Coefficient of Viscosity Ns/m ²
Air	0°C	0.017 × 10 ⁻³
	40°C	0.019 × 10 ⁻³
Water	20°C	1 × 10 ⁻³
	100°C	0.3 × 10 ⁻³
Machine oil	16°C	0.113 × 10 ⁻³
	38°C	0.034 × 10 ⁻³

2.7 Stokes' Law:

In 1845, Sir George Gabriel Stokes (1819-1903) stated the law which gives the viscous force acting on a spherical object falling through a viscous medium (see Fig. 2.31).

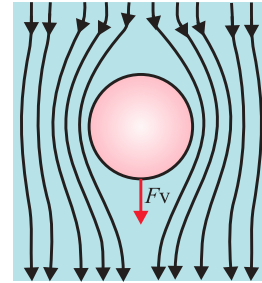

Fig 2.31: Spherical object moving through a viscous medium.

The law states that, “The viscous force (F_v) acting on a small sphere falling through a viscous medium is directly proportional to the radius of the sphere (r), its velocity (v) through the fluid, and the coefficient of viscosity (η) of the fluid”.

$$\therefore F_v \propto \eta r v$$

The empirically obtained constant of proportionality is 6π .

$$\therefore F_v = 6\pi\eta r v \quad \text{--- (2.36)}$$

This is the expression for viscous force acting on a spherical object moving through a viscous medium. The above formula can be derived using dimensional analysis.

Example 2.8: A steel ball with radius 0.3 mm is falling with velocity of 2 m/s at a time t , through a tube filled with glycerin, having coefficient of viscosity 0.833 Ns/m². Determine viscous force acting on the steel ball at that time.

Solution: Given

$$r = 0.3 \text{ mm} = 0.3 \times 10^{-3} \text{ m}, v = 2 \text{ m/s}, \eta = 0.833 \text{ Ns/m}^2.$$

We have, $F = 6\pi\eta r v$

$$F = 6 \times 3.142 \times 0.833 \times 0.3 \times 10^{-3} \times 2$$

Therefore, $F = 9.422 \times 10^{-3} \text{ N}$

2.7.1 Terminal Velocity:

Consider a spherical object falling through a viscous fluid. Forces experienced by it during its downward motion are,

1. Viscous force (F_v), directed upwards. Its magnitude goes on increasing with increase in its velocity.

- Gravitational force, or its weight (F_g), directed downwards, and
- Buoyant force or upthrust (F_u), directed upwards.

Net downward force given by $f = F_g - (F_v + F_u)$, is responsible for initial increase in the velocity. Among the given forces, F_g and F_u are constant while F_v increases with increase in velocity. Thus, a stage is reached when the net force f becomes zero. At this stage, $F_g = F_v + F_u$. After that, the downward velocity remains constant. This constant downward velocity is called *terminal velocity*. Obviously, now onwards, the viscous force F_v is also constant. *The entire discussion necessarily applies to streamline flow only.*

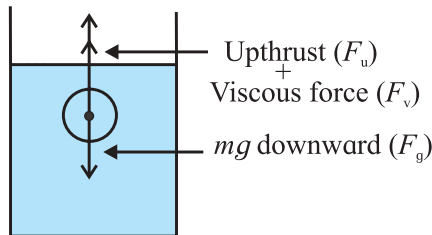

Fig. 2.32: Forces acting on object moving through a viscous medium.

Consider a spherical object falling under gravity through a viscous medium as shown in Fig. 2.32. Let the radius of the sphere be r , its mass m and density ρ . Let the density of the medium be σ and its coefficient of viscosity be η . When the sphere attains the terminal velocity, the total downward force acting on the sphere is balanced by the total upward force acting on the sphere.

Total downward force = Total upward force
 weight of sphere (mg) =
 viscous force + buoyant force due to the medium

$$\frac{4}{3}\pi r^3 \rho g = 6\pi\eta r v + \frac{4}{3}\pi r^3 \sigma g$$

$$6\pi\eta r v = \left(\frac{4}{3}\pi r^3 \rho g\right) - \left(\frac{4}{3}\pi r^3 \sigma g\right)$$

$$6\pi\eta r v = \left(\frac{4}{3}\right)\pi r^3 g (\rho - \sigma)$$

$$v = \left(\frac{4}{3}\right)\pi r^3 g (\rho - \sigma) \times \frac{1}{6\pi\eta r}$$

$$v = \left(\frac{2}{9}\right) \frac{r^2 g (\rho - \sigma)}{\eta} \quad \text{--- (2.37)}$$

This is the expression for the terminal velocity of the sphere. From Eq. (2.37) we can also write,

$$\eta = \frac{2}{9} \frac{r^2 (\rho - \sigma) g}{v} \quad \text{--- (2.38)}$$

The above equation gives coefficient of viscosity of a fluid.

Example 2.9: A spherical drop of oil falls at a constant speed of 4 cm/s in steady air. Calculate the radius of the drop. The density of the oil is 0.9 g/cm³, density of air is 1.0 g/cm³ and the coefficient of viscosity of air is 1.8×10^{-4} poise, ($g = 980$ cm/s²)

Solution: Given,

$$v = 4 \text{ cm/s}$$

$$\eta = 1.8 \times 10^{-4} \text{ Poise}$$

$$\sigma = 0.9 \text{ g/cm}^3$$

$$\rho = 1 \text{ g/cm}^3$$

We have,

$$\eta = \frac{2}{9} \frac{r^2 (\rho - \sigma) g}{v}$$

$$r = \sqrt{\frac{9\eta v}{2(\rho - \sigma) g}}$$

$$r = \sqrt{\frac{9 \times 1.8 \times 10^{-4} \times 4}{2 \times (1 - 0.9) \times 980}}$$

$$r = 0.574 \text{ cm}$$



Remember this

The velocity with which an object can move through a viscous fluid is always less than or equal to the terminal velocity in that fluid for that object.

2.8 Equation of Continuity:

Consider a steady flow of an incompressible fluid as shown in Fig. 2.33. For a steady flow, the velocity of a particle remains constant at a given point but it can vary from point to point. For example, consider section A_1 and A_2 in Fig. 2.33. Section A_1 has larger cross sectional area than the section A_2 . Let v_1 and v_2 be the velocities of the fluid at sections A_1 and A_2 respectively.

This is because, a particle has to move faster in the narrower section (where there is

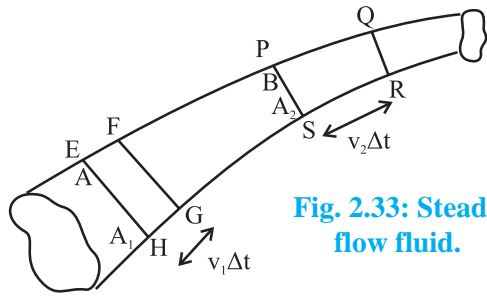

Fig. 2.33: Steady flow fluid.

less space) to accommodate particles behind it hence its velocity increases. When a particle enters a wider section, it slows down because there is more space. *Because the fluid is incompressible, the particles moves faster through a narrow section and slow down while moving through wider section.* If the fluid does not move faster in a narrow regain, it will be compressed to fit into the narrow space.

Consider a tube of flow as shown in Fig. 2.33. All the fluid that passes through a tube of flow must pass through any cross section that cuts the tube of flow. We know that all the fluid is confined to the tube of flow. Fluid can not leave the tube or enter the tube.

Consider section A_1 and A_2 located at points A and B respectively as shown in Fig. 2.33. Matter is neither created nor destroyed within the tube enclosed between section A_1 and A_2 . Therefore, the mass of the fluid within this region is constant over time. That means, if mass m of the fluid enters the section A_1 then equal mas of fluid should leave the section A_2 .

Let the speed of the fluid which crosses the section EFGH at point A in time interval Δt be v_1 . Thus, the volume of the fluid entering the tube through the cross section at point A is $\rho A_1 v_1 \Delta t$. Similarly, let the speed of the fluid be v_2 at point B. The fluid crosses the section PQRS of area A_2 in time interval Δt . Thus, the mass of the fluid leaving the tube through the cross section at B is $\rho A_2 v_2 \Delta t$.

As fluid is incompressible, the mass of the fluid entering the tube at point A is the same as the mass leaving the tube at B.

Mass of the fluid in section EFGH = mass of fluid in section PQRS

$$\rho A_1 v_1 \Delta t = \rho A_2 v_2 \Delta t \quad \text{--- (2.39)}$$

$$A_1 v_1 = A_2 v_2 \text{ or, } Av = \text{constant} \quad \text{--- (2.40)}$$

Av is the volume rate of flow of a fluid, i.e.,

$Av = \frac{dV}{dt}$. The quantity $\frac{dV}{dt}$ is the volume of a fluid per unit time passing through any cross section of the tube of flow. *It is called the volume flux.* Similarly, $\rho dV/dt = dm/dt$ is called mass flux.

Equation (2.40) is called the equation of continuity in fluid dynamics. The continuity equation says that the volume rate of flow of an incompressible fluid for a steady flow is the same throughout the flow.



Do you know?

When water is released from a dam, the amount of water is mentioned in terms of Thousand Million Cubic feet (TMC). One TMC is 10^9 cubic feet of water per second. Basic unit of measuring flow is cusec. One cusec is one cubic feet per sec (28.317 lit per sec).

Example 2.11: As shown in the given figure, a piston of cross sectional area 2 cm^2 pushes the liquid out of a tube whose area at the outlet is 40 mm^2 . The piston is pushed at a rate of 2 cm/s . Determine the speed at which the fluid leaves the tube.

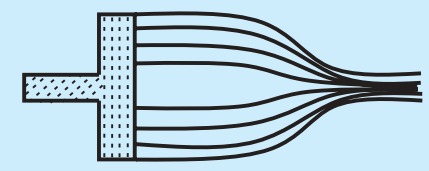

Solution: Given,
 $A_1 = 2 \text{ cm}^2 = 2 \times 10^{-4} \text{ m}^2$
 $v_1 = 2 \text{ cm/s} = 2 \times 10^{-2} \text{ m/s}$
 $A_2 = 40 \text{ mm}^2 = 40 \times 10^{-6} \text{ m}^2$
 From equation of continuity, $A_1 v_1 = A_2 v_2$
 Therefore,

$$v_2 = \frac{A_1 v_1}{A_2} = \frac{2 \times 10^{-4} \times 2 \times 10^{-2}}{40 \times 10^{-6}} = 0.1 \text{ m/s}$$



Use your brain power

A water pipe with a diameter of 5.0 cm is connected to another pipe of diameter 2.5 cm. How would the speeds of the water flow compare?

**Do you know?**

1. How does an aeroplane take off?
2. Why do racer cars and birds have typical shape?
3. Have you experienced a sideways jerk while driving a two wheeler when a heavy vehicle overtakes you?
4. Why does dust get deposited only on one side of the blades of a fan?
5. Why helmets have specific shape?

2.9 Bernoulli Equation:

On observing a river, we notice that the speed of the water decreases in wider region whereas the speed of water increases in the regions where the river is narrow. From this we might think that the pressure in narrower regions is more than that in the wider region. However, the pressure within the fluid in the narrower parts is less while that in wider parts is more.

Swiss scientist Daniel Bernoulli (1700-1782), while experimenting with fluid inside pipes led to the discovery of the concept mentioned above. He observed, in his experiment, that the speed of a fluid in a narrow region increases but the internal pressure of a fluid in the same narrow region decreases. This phenomenon is called *Bernoulli's principle*.

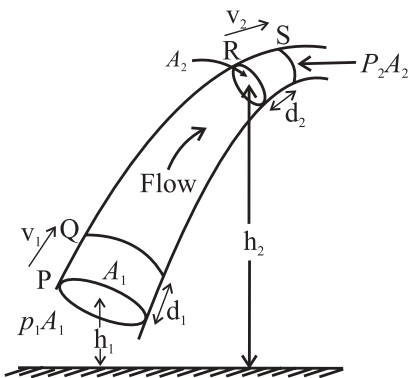

Fig. 2.34: Flow of fluid through a tube of varying cross section and height.

Bernoulli's equation relates the speed of a fluid at a point, the pressure at that point and the height of that point above a reference level. It is an application of work – energy theorem for a fluid in flow. While deriving Bernoulli's equation, we will prove that the net work done on a fluid element by the pressure of the

surrounding fluid is equal to the sum of the change in the kinetic energy and the change in the gravitational potential energy.

Figure 2.34 shows flow of an ideal fluid through a tube of varying cross section and height. Consider an element of fluid that lies between cross sections P and R.

Let,

- v_1 and v_2 be the speed the fluid at the lower end P and the upper end R respectively.
- A_1 and A_2 be the cross section area of the fluid at the lower end P and the upper end R respectively.
- p_1 and p_2 be the pressures of the fluid at the lower end P and the upper R respectively.
- d_1 and d_2 be the distances travelled by the fluid at the lower and P and the upper and R during the time interval dt with velocities v_1 and v_2 respectively.
- $p_1 A_1$ and $p_2 A_2$ be the forces acting on the equation of continuity, (Eq. 2.40), the volume dV of the fluid passing through any cross section during time interval dt is the same; i.e.,

$$dV = A_1 d_1 = A_2 d_2 \quad \text{--- (2.41)}$$

There is no internal friction in the fluid as the fluid is ideal. In practice also, for a fluid like water, the loss in energy due to viscous force is negligible. So the only *non-gravitational* force that does work on the fluid element is due to the pressure of the surrounding fluid. Therefore, the net work, W , done on the element by the surrounding fluid during the flow from P to R is,

$$W = p_1 A_1 d_1 - p_2 A_2 d_2$$

The second term in the above equation has a negative sign because the force at R opposes the displacement of the fluid. From Eq. (2.41) the above equation can be written as,

$$W = p_1 dV - p_2 dV$$

$$\therefore W = (p_1 - p_2) dV \quad \text{--- (2.42)}$$

As the work W is due to forces other than the conservative force of gravity, it equals the change in the total mechanical energy i.e., kinetic energy plus gravitational potential energy associated with the fluid element.

$$\text{i.e., } W = \Delta K.E. + \Delta P.E. \quad \text{--- (2.43)}$$

The mechanical energy for the fluid between sections Q and R does not change.

At the beginning of the time interval dt , the mass and the kinetic energy of the fluid between P and Q is, $\rho A_1 d_1$, and $\frac{1}{2} \rho (A_1 d_1) v_1^2$ respectively. At the end of the time interval dt , the kinetic energy of the fluid between section R and S is $\frac{1}{2} \rho (A_2 d_2) v_2^2$. Therefore, the net change in the kinetic energy, $\Delta K.E.$, during time interval dt is,

$$\Delta K.E. = \frac{1}{2} \rho (A_2 d_2) v_2^2 - \frac{1}{2} \rho (A_1 d_1) v_1^2$$

$$\Delta K.E. = \frac{1}{2} \rho dV v_2^2 - \frac{1}{2} \rho dV v_1^2$$

$$\Delta K.E. = \frac{1}{2} \rho dV (v_2^2 - v_1^2) \quad \text{--- (2.44)}$$

Also, at the beginning of the time interval dt , the gravitational potential energy of the mass m between P and Q is $mgh_1 = \rho dVgh_1$. At the end of the interval dt , the gravitational potential energy of the mass m between R and S is $mgh_2 = \rho dVgh_2$. Therefore, the net change in the gravitational potential energy, $\Delta P.E.$, during time interval dt is,

$$\Delta P.E. = \rho dVgh_2 - \rho dVgh_1$$

$$\Delta P.E. = \rho dVg (h_2 - h_1) \quad \text{--- (2.45)}$$

Substituting Eq. (2.42), (2.44) and (2.45) in Eq. (2.43) we get,

$$(p_1 - p_2) dV = \frac{1}{2} \rho dV (v_2^2 - v_1^2) + \rho dVg (h_2 - h_1)$$

$$\therefore (p_1 - p_2) = \frac{1}{2} \rho (v_2^2 - v_1^2) + \rho g (h_2 - h_1) \quad \text{--- (2.46)}$$

This is Bernoulli's equation. It states that **the work done per unit volume of a fluid by the surrounding fluid is equal to the sum of the changes in kinetic and potential energies per unit volume that occur during the flow.** Equation (2.46) can also be written as,

$$p_1 + \frac{1}{2} \rho v_1^2 + \rho gh_1 = p_2 + \frac{1}{2} \rho v_2^2 + \rho gh_2 \quad \text{--- (2.47)}$$

or, $p + \frac{1}{2} \rho v^2 + \rho gh = \text{constant} \quad \text{--- (2.48)}$

A different way of interpreting the Bernoulli's equation:

$$(p_1 - p_2) = \frac{1}{2} \rho (v_2^2 - v_1^2) + \rho g (h_2 - h_1)$$

Dimensionally, pressure is energy per unit volume. Both terms on the right side of the above equation have dimensions of energy per unit volume. Hence, quite often, the left side is referred to as pressure energy per unit volume. The left side of equation is called pressure head. The first term on the right side is called the velocity head and the second term is called the potential head.

In other words, the Bernoulli's principle is thus consistent with the principle of conservation of energy.

Example 2.12: The given figure shows a streamline flow of a non-viscous liquid having density 1000 kg/m^3 . The cross sectional area at point A is 2 cm^2 and at point B is 1 cm^2 . The speed of liquid at the point A is 5 cm/s . Both points A and B are at the same horizontal level. Calculate the difference in pressure at A and B.



Solution: Given,
 $\rho = 1000 \text{ kg/m}^3$, $A_1 = 2 \text{ cm}^2 = 2 \times 10^{-2} \text{ m}^2$
 $A_2 = 1 \text{ cm}^2 = 10^{-2} \text{ m}^2$, $v_1 = 5 \text{ cm/s} = 5 \times 10^{-2} \text{ m/s}$ and $h_1 = h_2$
 From the equation of continuity,

$$A_1 v_1 = A_2 v_2$$

$$\therefore v_2 = \frac{A_1 v_1}{A_2} = \frac{2 \times 5 \times 10^{-2}}{10^{-2}} = 10 \text{ m/s}$$

By Bernoulli's equation,

$$(p_1 - p_2) dV = \frac{1}{2} \rho dV (v_2^2 - v_1^2) + \rho dVg (h_2 - h_1)$$

(since, $h_2 - h_1 = 0$)

$$(p_1 - p_2) dV = \frac{1}{2} \rho dV (v_2^2 - v_1^2)$$

$$= \frac{1}{2} \times 1000 \times (100 - 0.0025)$$

$$= 500 \times 99.99$$

$$p_1 - p_2 = 49998.75, \text{ Pa} = 4.99 \times 10^5 \text{ Pa}$$



Use your brain power

Does the Bernoulli's equation change when the fluid is at rest? How?

Applications of Bernoulli's equation:

a) Speed of efflux:

The word efflux means fluid out flow. Torricelli discovered that the speed of efflux from an open tank is given by a formula identical to that of a freely falling body.

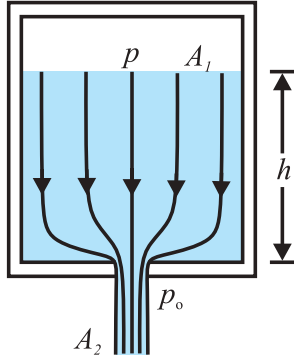

Fig. 2.35: Efflux of fluid from an orifice.

Consider a liquid of density 'ρ' filled in a tank of large cross-sectional area A_1 having an orifice of cross-sectional area A_2 at the bottom as shown in Fig. 2.35. Let $A_2 \ll A_1$. The liquid flows out of the tank through the orifice. Let v_1 and v_2 be the speeds of the liquid at A_1 and A_2 respectively. As both, inlet and outlet, are exposed to the atmosphere, the pressure at these position equals the atmosphere pressure p_0 . If the height of the free surface above the orifice is h , Bernoulli's equation gives us,

$$p_0 + \frac{1}{2} \rho v_1^2 + \rho gh = p_0 + \frac{1}{2} \rho v_2^2 \quad \text{--- (2.49)}$$

Using equation the of continuity we can write,

$$v_1 = \frac{A_2}{A_1} v_2$$

Substituting v_1 in Eq.(2.49) we get,

$$\frac{1}{2} \rho \left(\frac{A_2}{A_1} \right)^2 v_2^2 + \rho gh = \frac{1}{2} \rho v_2^2$$

$$\left(\frac{A_2}{A_1} \right)^2 v_2^2 + 2gh = v_2^2$$

$$2gh = v_2^2 - \left(\frac{A_2}{A_1} \right)^2 v_2^2$$

$$\therefore \left[1 - \left(\frac{A_2}{A_1} \right)^2 \right] v_2^2 = 2gh$$

If $A_2 \ll A_1$, the above equation reduces to,

$$v_2 = \sqrt{2gh} \quad \text{--- (2.50)}$$

This is the equation of the speed of a liquid flowing out through an orifice at a depth 'h' below the free surface. It is the same as that of a particle falling freely through the height 'h' under gravity.

Example 2.13: Doors of a dam are 20 m below the surface of water in the dam. If one door is opened, what will be the speed of the water that flows out of the door? ($g = 9.8 \text{ m/s}^2$)

Solution: Given, $h = 20 \text{ m}$

From Toricelli's law,

$$v = \sqrt{2gh} = \sqrt{2 \times 9.8 \times 20} = \sqrt{392} = 19.79 \text{ m/s}$$

b) Ventury tube:

A ventury tube is used to measure the speed of flow of a fluid in a tube. It has a constriction in the tube. As the fluid passes through the constriction, its speed increases in accordance with the equation of continuity. The pressure thus decreases as required by the Bernoulli equation.

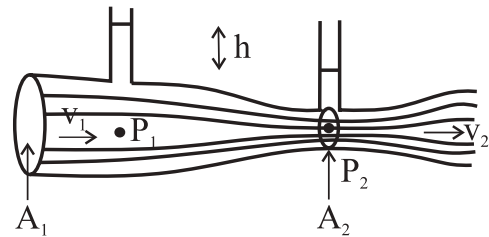

Fig. 2.36: Ventury tube.

The fluid of density ρ flows through the Ventury tube. The area of cross section is A_1 at wider part and A_2 at the constriction. Let the speeds of the fluid at A_1 and A_2 be v_1 and v_2 , and the pressures, be p_1 and p_2 respectively. From Bernoulli's equation,

$$p_1 + \frac{1}{2} \rho v_1^2 = p_2 + \frac{1}{2} \rho v_2^2$$

$$(p_1 - p_2) = \frac{1}{2} \rho (v_2^2 - v_1^2) \quad \text{--- (2.51)}$$

Figure 2.36 shows two vertical tubes connected

to the Ventury tube at A_1 and A_2 . If the difference in height of the liquid levels in the tubes is h , we have,

$$(p_1 - p_2) = \rho gh$$

Substituting above equation in Eq. (2.51) we get,

$$2gh = v_2^2 - v_1^2 \quad \text{--- (2.52)}$$

From the equation of continuity, $A_1 v_1 = A_2 v_2$, substituting v_1 in terms of v_2 or vice versa in Eq. (2.52) the rate of flow of liquid passing through a cross section can be calculated by knowing the areas A_1 and A_2 .

Example 2.13: Water flows through a tube as shown in the given figure. Find the difference in mercury level, if the speed of flow of water at point A is 2 m/s and at point B is 5 m/s. ($g = 9.8 \text{ m/s}$)

Solution: Given, $v_1 = 2 \text{ m/s}$, $v_2 = 5 \text{ m/s}$
We have,

$$2gh = v_2^2 - v_1^2$$

therefore,

$$h = \frac{v_2^2 - v_1^2}{2g} = \frac{25 - 4}{2 \times 9.8} = \frac{21}{19.6} = 1.07 \text{ m}$$

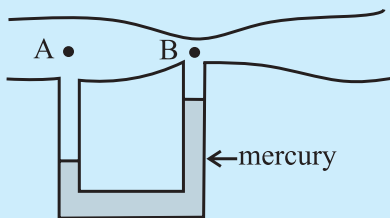

c) Lifting up of an aeroplane:

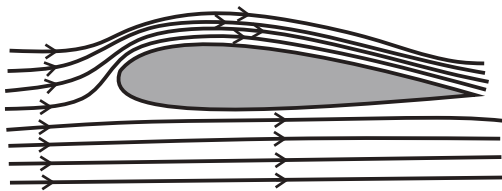

Fig. 2.37: Airflow along an aerofoil.

The shape of cross section of wings of an aeroplane is as shown in Fig. 2.37. When an aeroplane runs on a runway, due to aerodynamic shape of its wings, the streamlines of air are crowded above the wings compared to those below the wings. Thus, the air above the wings moves faster than that below the wings. According to the Bernoulli's principle, the pressure above the wings decreases and

that below the wings increases. Due to this pressure difference, an upward force called the *dynamic lift* acts on the bottom of the wings of a plane. When this force becomes greater than the weight of aeroplane, the aeroplane takes off.

d) Working of an atomizer:

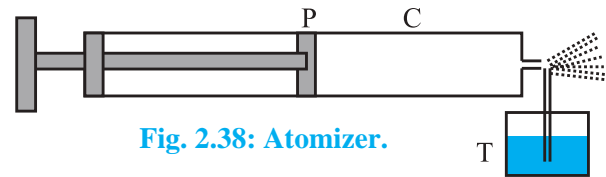

Fig. 2.38: Atomizer.

The action of the carburetor of an automobile engine, paint-gun, scent-spray or insect-sprayer is based on the Bernoulli's principle. In all these, a tube T is dipped in a liquid as shown in Fig. 2.38. Air is blown at high speed over the tip of this tube with the help of a piston P in the cylinder C. This high speed air creates low pressure over the tube, due to which the liquid rises in it and is then blown off in very small droplets with expelled air.

e) Blowing off of roofs by stormy wind:

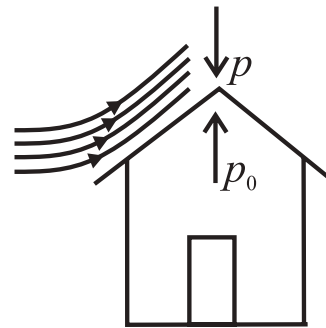

Fig. 2.39: Airflow along a roof.

When high speed, stormy wind blows over a roof top, it causes low pressure p above the roof in accordance with the Bernoulli's principle. However, the air below the roof (i.e. inside the room) is still at the atmospheric pressure p_0 . So, due to this difference in pressure, the roof is lifted up and is then blown off by the wind as shown in Fig. 2.39.



Observe and discuss

Observe the shape of blades of a fan and discuss the nature of the air flow when fan is switched on.

**Internet my friend**

- <http://hyperphysics.phy-astr.gsu.edu/hbase/pfric.html>
- <https://opentextbc.ca/physicstestbook2/chapter/chapter-1/>
- <https://opentextbc.ca/physicstestbook2/chapter/pressure/>
- <https://opentextbc.ca/physicstestbook2/chapter/bernoullis-equation/>
- <https://opentextbc.ca/physicstestbook2/chapter/viscosity-and-laminar-flow-poiseuilles-law/>
- <http://hyperphysics.phy-astr.gsu.edu/hbase/html>
- <http://hyperphysics.phy-astr.gsu.edu/hbase/pascon.html>
- <http://hyperphysics.phy-astr.gsu.edu/hbase/fluid.html#flucon>

**Exercises****1) Multiple Choice Questions**

- A hydraulic lift is designed to lift heavy objects of maximum mass 2000 kg. The area of cross section of piston carrying the load is $2.25 \times 10^{-2} \text{ m}^2$. What is the maximum pressure the smaller piston would have to bear?
(A) $0.8711 \times 10^6 \text{ N/m}^2$
(B) $0.5862 \times 10^7 \text{ N/m}^2$
(C) $0.4869 \times 10^5 \text{ N/m}^2$
(D) $0.3271 \times 10^4 \text{ N/m}^2$
- Two capillary tubes of radii 0.3 cm and 0.6 cm are dipped in the same liquid. The ratio of heights through which the liquid will rise in the tubes is
(A) 1:2 (B) 2:1 (C) 1:4 (D) 4:1
- The energy stored in a soap bubble of diameter 6 cm and $T = 0.04 \text{ N/m}$ is nearly
(A) $0.9 \times 10^{-3} \text{ J}$ (B) $0.4 \times 10^{-3} \text{ J}$
(C) $0.7 \times 10^{-3} \text{ J}$ (D) $0.5 \times 10^{-3} \text{ J}$
- Two hail stones with radii in the ratio of 1:4 fall from a great height through the atmosphere. Then the ratio of their terminal velocities is
(A) 1:2 (B) 1:12 (C) 1:16 (D) 1:8
- In Bernoulli's theorem, which of the following is conserved?
(A) linear momentum
(B) angular momentum
(C) mass
(D) energy

2) Answer in brief.

- Why is the surface tension of paints and lubricating oils kept low?
 - How much amount of work is done in forming a soap bubble of radius r ?
 - What is the basis of the Bernoulli's principle?
 - Why is a low density liquid used as a manometric liquid in a physics laboratory?
 - What is an incompressible fluid?
- Why two or more mercury drops form a single drop when brought in contact with each other?
 - Why does velocity increase when water flowing in broader pipe enters a narrow pipe?
 - Why does the speed of a liquid increase and its pressure decrease when a liquid passes through constriction in a horizontal pipe?
 - Derive an expression of excess pressure inside a liquid drop.
 - Obtain an expression for conservation of mass starting from the equation of continuity.
 - Explain the capillary action.
 - Derive an expression for capillary rise for a liquid having a concave meniscus.

10. Find the pressure 200 m below the surface of the ocean if pressure on the free surface of liquid is one atmosphere. (Density of sea water = 1060 kg/m^3)
[Ans. $21.789 \times 10^5 \text{ N/m}^2$]
11. In a hydraulic lift, the input piston had surface area 30 cm^2 and the output piston has surface area of 1500 cm^2 . If a force of 25 N is applied to the input piston, calculate weight on output piston.
[Ans. 1250 N]
12. Calculate the viscous force acting on a rain drop of diameter 1 mm, falling with a uniform velocity 2 m/s through air. The coefficient of viscosity of air is $1.8 \times 10^{-5} \text{ Ns/m}^2$.
[Ans. $3.393 \times 10^{-7} \text{ N}$]
13. A horizontal force of 1 N is required to move a metal plate of area 10^{-2} m^2 with a velocity of $2 \times 10^{-2} \text{ m/s}$, when it rests on a layer of oil $1.5 \times 10^{-3} \text{ m}$ thick. Find the coefficient of viscosity of oil.
[Ans. 7.5 Ns/m^2]
14. With what terminal velocity will an air bubble 0.4 mm in diameter rise in a liquid of viscosity 0.1 Ns/m^2 and specific gravity 0.9? Density of air is 1.29 kg/m^3 .
[Ans. $-0.782 \times 10^{-3} \text{ m/s}$, The negative sign indicates that the bubble rises up]
15. The speed of water is 2m/s through a pipe of internal diameter 10 cm. What should be the internal diameter of nozzle of the pipe if the speed of water at nozzle is 4 m/s?
[Ans. $7.07 \times 10^{-2} \text{ m}$]
16. With what velocity does water flow out of an orifice in a tank with gauge pressure $4 \times 10^5 \text{ N/m}^2$ before the flow starts? Density of water = 1000 kg/m^3 .
[Ans. 28.28 m/s]
17. The pressure of water inside the closed pipe is $3 \times 10^5 \text{ N/m}^2$. This pressure reduces to $2 \times 10^5 \text{ N/m}^2$ on opening the value of the pipe. Calculate the speed of water flowing through the pipe. (Density of water = 1000 kg/m^3).
[Ans. 14.14 m/s]
18. Calculate the rise of water inside a clean glass capillary tube of radius 0.1 mm, when immersed in water of surface tension $7 \times 10^{-2} \text{ N/m}$. The angle of contact between water and glass is zero, density of water = 1000 kg/m^3 , $g = 9.8 \text{ m/s}^2$.
[Ans. 0.142 m]
19. An air bubble of radius 0.2 mm is situated just below the water surface. Calculate the gauge pressure. Surface tension of water = $7.2 \times 10^{-2} \text{ N/m}$.
[Ans. 7200 N/m^2]
20. Twenty seven droplets of water, each of radius 0.1 mm coalesce into a single drop. Find the change in surface energy. Surface tension of water is 0.072 N/m .
[Ans. $1.628 \times 10^{-3} \text{ J}$]
21. A drop of mercury of radius 0.2 cm is broken into 8 droplets of the same size. Find the work done if the surface tension of mercury is 435.5 dyne/cm .
[Ans. $2.18 \times 10^{-5} \text{ J}$]
22. How much work is required to form a bubble of 2 cm radius from the soap solution having surface tension 0.07 N/m .
[Ans. $0.703 \times 10^{-3} \text{ J}$]
23. A rectangular wire frame of size $2 \text{ cm} \times 2 \text{ cm}$, is dipped in a soap solution and taken out. A soap film is formed, if the size of the film is changed to $3 \text{ cm} \times 3 \text{ cm}$, calculate the work done in the process. The surface tension of soap film is $3 \times 10^{-2} \text{ N/m}$.
[Ans. $3 \times 10^{-5} \text{ J}$]

3. Kinetic Theory of Gases and Radiation



Can you recall?

1. What are different states of matter?
2. How do you distinguish between solid, liquid and gaseous states?
3. What are gas laws?
4. What is absolute zero temperature?
5. What is Avogadro number? What is a mole?
6. How do you get ideal gas equation from the gas laws?
7. How is ideal gas different from real gases?
8. What is elastic collision of particles?
9. What is Dalton's law of partial pressures?

3.1. Introduction:

You have been introduced to the three common states of matter viz. solid, liquid and gas. You have also studied the gas laws: Boyle's law, Charles' law, and Gay-Lussac's law. The ideal gas equation can be obtained from the three gas laws.

The volume V of a gas is inversely proportional to the pressure P , temperature being held constant. Separately, volume V and pressure P are directly proportional to temperature. In a nut shell,

Boyle's law: $V \propto 1/P$ at constant T --- (3.1)

Charles' law $V \propto T$ at constant P --- (3.2)

Gay-Lussac's law: $P \propto T$ at constant V --- (3.3)

All the three laws apply to fixed mass m of an enclosed gas.

Combining the three laws into a single relation for a fixed mass of gas yields ideal gas equation. Thus,

$$PV \propto T, \text{ or } \frac{P_1 V_1}{T_1} = \frac{P_2 V_2}{T_2}$$

Expressing the fixed mass of gas in the above three laws in terms of number of moles n of gas, $PV \propto nT$, or $PV = nRT$,

where number of moles

$$n = \frac{\text{mass of the gas } (M)}{\text{molar mass } (M_0)} = \frac{N}{N_A}$$

(Molar mass is the mass of 1 mole of gas)

Here, proportionality constant R is the universal gas constant, having the same value $8.314 \text{ J mol}^{-1} \text{ K}^{-1}$, for all the gases, N is the number of molecules in the gas and N_A is the Avogadro number and is the number of molecules in one mole of gas.

Alternatively,

$$PV = Nk_B T, \quad \text{--- (3.4)}$$

where k_B is the Boltzmann constant. R and k_B are related by the following relation:

$$R = N_A k_B \quad \text{--- (3.5)}$$

The laws of Boyle, Charles, and Gay-Lussac are strictly valid for real gases, only if the pressure of the gas is not too high and the temperature is not close to the liquefaction temperature of the gas.

A gas obeying the equation of state $PV = nRT$ at all pressures, and temperatures is an ideal gas.

Equation of State: For a gas, its state is specified by a number of physical quantities such as pressure P , temperature T , volume V , internal energy E , etc. Hence, the equation relating these quantities is known as the *equation of state*.

3.2 Behaviour of a Gas:

A stone thrown upwards in air reaches a certain height and falls back to the ground. Its motion can be described well with the help of Newton's laws of motion. A gas enclosed in a container is characterized by its pressure, volume and, temperature. This is the macroscopic description of the gas. You know that the particles of the gas (molecules) are in constant motion. Unlike in the case of motion of the stone, it is very difficult to understand the behaviour of a gas in terms of motion of a single particle (molecule). The number of particles in the gas is itself so large ($\sim 10^{23}$ particles per m^3) that any attempt to relate the macroscopic parameters P , V , T and E with the motion of individual particles would be futile.

Hence, certain assumptions are made regarding the particles (molecules) of a gas, averages of physical quantities over the large number of particles involved are obtained and these averages are finally related to the macroscopic parameters of the gas. This is the approach of kinetic theory of gases.

3.3 Ideal Gas and Real Gas:

We know that a gas obeying ideal gas equation at all pressures and temperatures is an ideal gas. In an ideal gas intermolecular interactions are absent. Real gases are composed of atoms or molecules which do interact with each other. Hence, no real gas is truly ideal as defined here. If the atoms/molecules of a real gas are so far apart that there is practically no interatomic/intermolecular interaction, the real gas is said to be in the ideal state. This can happen at sufficiently low density of the real gas. At low pressures or high temperatures, the molecules are far apart and therefore molecular interactions are negligible. Under these conditions, behaviour of real gases is close to that of an ideal gas. Of course, the temperature of the real gas must be well above its liquefaction temperature. Ideal gas serves as a model to deduce certain properties of real gases at least when the real gas is in the ideal state. You have studied deviation of real gas from ideal gas behaviour in XIth Std. Chemistry.



Can you tell?

1. Why is the deviation of real gas from ideal gas behavior observed at high pressure and low temperature?
2. What is the effect of size of the molecules of a real gas, as against the ideal gas comprising point particles, on the properties of the gas ?
3. Does an ideal gas exist in reality?

3.4 Mean Free Path:

How do the molecules of an ideal gas move? These molecules are in continuous random motion such as Brownian motion you have studied in XIth Std. Chemistry.

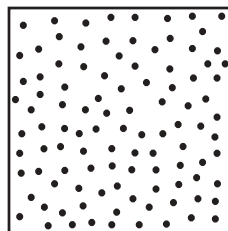

Fig. 3.1 (a): A gas with molecules dispersed in the container: A stop action photograph.

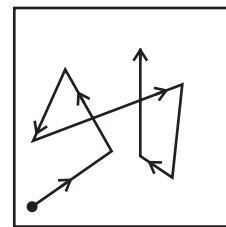

Fig. 3.1 (b): A typical molecule in a gas executing random motion.

The molecules of a gas are uniformly dispersed throughout the volume of the gas as shown in Fig 3.1(a). These molecules are executing random motion. Typical path of a molecule is shown in Fig. 3.1 (b). When a molecule approaches another molecule, there is a repulsive force between them, due to which the molecules behave as small hard spherical particles. This leads to elastic collisions between the molecules. Therefore, both the speed and the direction of motion of the molecules change abruptly. The molecules also collide with the walls of the container. Molecules exert force on each other only during collisions. Thus, in between two successive collisions the molecules move along straight paths with constant velocity. It is convenient and useful to define mean free path (λ), as the average distance traversed by a molecule with constant velocity between two successive collisions. The mean free path is expected to vary inversely with the density of the gas $\rho = \frac{N}{V}$, where N is the number of molecules enclosed in a volume V . Higher the density, more will be the collisions and smaller will be the mean free path λ . It is also seen that λ is inversely proportional to the size of the molecule, say the diameter d . Smaller the size of the molecule, less is the chance for collision and larger is the mean free path. Further, λ is inversely proportional to d^2 , not just d , because it depends on the cross section of a molecule. It can be shown that

$$\lambda = \frac{1}{\sqrt{2}\pi d^2(N/V)} \quad \text{--- (3.6)}$$

Example: 3.1 Obtain the mean free path of nitrogen molecule at 0 °C and 1.0 atm pressure. The molecular diameter of nitrogen is 324 pm (assume that the gas is ideal).

Solution: Given $T = 0\text{ }^\circ\text{C} = 273\text{ K}$, $P = 1.0\text{ atm} = 1.01 \times 10^5\text{ Pa}$ and $d = 324\text{ pm} = 324 \times 10^{-12}\text{ m}$.

For ideal gas $PV = Nk_B T$, $\therefore \frac{N}{V} = \frac{P}{k_B T}$.

Using Eq. (3.6), mean free path

$$\lambda = \frac{1}{\sqrt{2}\pi d^2 \left(\frac{N}{V}\right)} = \frac{k_B T}{\sqrt{2}\pi d^2 P}$$

$$= \frac{(1.38 \times 10^{-23}\text{ J/K})(273\text{ K})}{\sqrt{2}\pi (324 \times 10^{-12}\text{ m})^2 (1.01 \times 10^5\text{ Pa})}$$

$$= 0.8 \times 10^{-7}\text{ m}$$

Note that this is about 247 times molecular diameter.

If the pressure of a gas in an enclosure is reduced by evacuating it, the density of the gas decreases and the mean free path increases. You must have seen articles coated with metal films. The metals are heated and evaporated in an enclosure. The pressure in the enclosure is reduced so that the mean free path of air molecules is larger than the dimensions of the enclosure. The atoms in the metal vapour then do not collide with the air molecules. They reach the target and get deposited.

3.5 Pressure of Ideal Gas:

We now express pressure of an ideal gas as a kinetic theory problem. Let there be n moles of an ideal gas enclosed in a cubical box of volume $V (= L^3)$ with sides of the box parallel to the coordinate axes, as shown in Fig. 3.2. The walls of the box are kept at a constant temperature T . The question is: can we relate the pressure P of the gas with the molecular speeds? Here we will use the word molecular speed rather than molecular velocity since the kinetic energy of a molecule depends on the velocity irrespective of its direction.

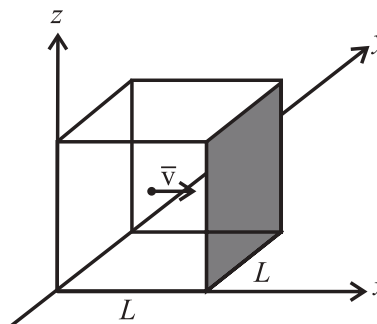
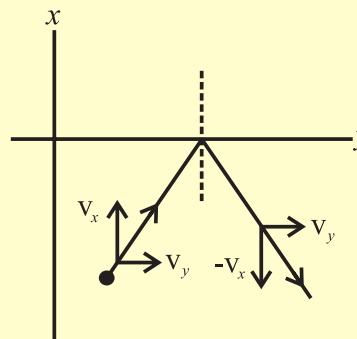

Fig. 3.2: A cubical box of side L . It contains n moles of an ideal gas. The figure shows a molecule of mass m moving towards the shaded wall of the cube with velocity \vec{v} .

The gas molecules are continuously moving randomly in various directions, colliding with each other and hitting the walls of the box and bouncing back. As a first approximation, we neglect intermolecular collisions and consider only elastic collisions with the walls. (It is not unphysical to assume this, because, as explained earlier, the mean free path increases as the pressure is reduced. Thus, pressure is so adjusted that the molecules do not collide with each other, but collide with the walls). A typical molecule is shown in the Fig. 3.2 moving with the velocity \vec{v} , about to collide with the shaded wall of the cube. The wall is parallel to yz -plane. As the collision is assumed to be elastic, during collision, the component v_x of the velocity will get reversed, keeping v_y and v_z components unaltered.

Consider two dimensional elastic collision of a particle with a wall along the y -axis as shown in the accompanying figure. It can be easily seen that the v_x component is reversed, v_y remaining unchanged.



Considering all the molecules, their average y and z components of the velocities are not changed by collisions with the shaded wall. This can be understood from the fact that the gas molecules remain evenly distributed throughout the volume and do not get any additional motion in $+y$ or $-y$ and $+z$ or $-z$ directions. Thus the y and z components remain unchanged during collision with the wall parallel to the yz -plane.

Hence the change in momentum of the particle is only in the x component of the momentum, Δp_x is given by

$$\begin{aligned}\Delta p_x &= \text{final momentum} - \text{initial momentum} \\ &= (-mv_x) - (mv_x) = -2mv_x \quad \text{--- (3.7)}\end{aligned}$$

Thus, the momentum transferred to the wall during collision is $+2mv_x$. The rebounded molecule then goes to the opposite wall and collides with it.

We now set the average force exerted by one molecule on the wall equal to the average rate of change of momentum during the time for one collision. To find this average rate, we have to divide the change in momentum by the time taken for one collision.

After colliding with the shaded wall, the molecule travels to the opposite wall and is reflected back. It travels back towards the shaded wall again to collide with the shaded wall. This means that the molecule travels a distance of $2L$ in between two collisions. Hence to get the average force, we have to divide by the time between two successive collisions.

As L is the length of the cubical box, the time for the molecule to travel back and forth to the shaded wall is $\Delta t = \frac{2L}{v_x}$.

Average force exerted on the shaded wall by molecule 1 is given as

$$\begin{aligned}\text{Average force} &= \text{Average rate of change of momentum} \\ &= \frac{2mv_{x1}}{2L/v_{x1}} = \frac{mv_{x1}^2}{L} \quad \text{--- (3.8)}\end{aligned}$$

where v_{x1} is the x component of the velocity of molecule 1.

Considering other molecules 2, 3, 4 ... with the respective x components of velocities $v_{x2}, v_{x3}, v_{x4}, \dots$, the total average force on the wall from Eq. (3.8), is

$$= \frac{m}{L} (v_{x1}^2 + v_{x2}^2 + v_{x3}^2 + \dots)$$

\therefore The average pressure

$$\begin{aligned}P &= \frac{\text{Average force}}{\text{Area of shaded wall}} \\ &= \frac{m(v_{x1}^2 + v_{x2}^2 + \dots)}{L \cdot L}\end{aligned}$$

The average of the square of the x component of the velocities is given by

$$\overline{v_x^2} = \frac{v_{x1}^2 + v_{x2}^2 + v_{x3}^2 + \dots + v_N^2}{N}$$

$$\therefore P = \frac{mN\overline{v_x^2}}{V} \quad \text{--- (3.9)}$$

where $\overline{v_x^2}$ is the average over all possible values of v_x .

$$\text{Now } \overline{v^2} = \overline{v_x^2} + \overline{v_y^2} + \overline{v_z^2}$$

By symmetry, $\overline{v_x^2} = \overline{v_y^2} = \overline{v_z^2} = \frac{1}{3}\overline{v^2}$ since the molecules have no preferred direction to move. Therefore, average pressure

$$P = \frac{1}{3} \frac{N}{V} m \overline{v^2} \quad \text{--- (3.10)}$$

Equation (3.10) has been obtained for a cubical shaped container. However, it can be shown to be valid for containers of any shape. Also, we have assumed that there are no intermolecular collisions. The number of molecules in the container is so large (of the order of 10^{23}) that even if molecular collisions are taken into account, the above expression does not change. If a molecule acquires a velocity with components different than v_x, v_y, v_z after collision, there will invariably be some other molecule having different initial velocity now acquiring the velocity with the components v_x, v_y, v_z . As the gas is steady (in equilibrium), this must be happening. Thus the collisions do not affect Eq. (3.10).

3.6 Root Mean Square (rms) Speed:

Equation (3.10) gives the mean square speed of the molecules of a gas.

$$\overline{v^2} = \frac{3PV}{Nm} \quad \text{--- (3.11)}$$

Using ideal gas equation $PV = nRT$,

$$\therefore \overline{v^2} = \frac{3nRT}{Nm} = \frac{3NRT}{N_A Nm}$$

$$\therefore \sqrt{\overline{v^2}} = v_{\text{rms}} = \sqrt{\frac{3RT}{M_0}} \quad \text{--- (3.12)}$$

where $M_0 = N_A m$ is the molar mass of the gas. Equation (3.12) allows us to estimate rms speeds of molecules of real gases. For nitrogen gas, at 300 K, the rms speed is 517 m/s, while for oxygen gas it is 483 m/s.

You have studied passage of sound waves through air medium. Speed of sound in a gas is $v_s = \sqrt{\frac{\gamma RT}{M_0}}$, where $\gamma = \frac{C_p}{C_v}$ is called the adiabatic ratio. Its maximum value is 5/3, for monatomic gases. The sound wave cannot move faster than the average speed of the molecules (since $\gamma < 3$). However, the two speeds are of the same order of magnitude. The molecules serve as a medium to transport sound energy. The speed of sound in H_2 gas is comparable to the rms speed of H_2 molecules and in N_2 gas to the rms speed of N_2 molecules.

3.7 Interpretation of Temperature in Kinetic Theory:

Equation (3.10) can be written as

$$PV = \frac{1}{3} Nm \overline{v^2} = \frac{2}{3} N \cdot \left(\frac{1}{2} m \overline{v^2} \right) \quad \text{--- (3.13)}$$

The quantity $\frac{1}{2} m \overline{v^2}$ is the average translational kinetic energy of a molecule. In an ideal gas, the molecules are noninteracting, and hence there is no potential energy term. Thus, the internal energy of an ideal gas is purely kinetic.

The average total energy E , therefore, is

$$E = N \cdot \frac{1}{2} m \overline{v^2} \quad \text{--- (3.14)}$$

From Eq. (3.13),

Do you know?

Distribution of speeds of molecules:

We know that the molecules of a gas are in continuous random motion. Magnitudes of their velocities i.e., the speeds are varying. In the previous sections we saw that root mean square speed, v_{rms} , is a kind of average speed at a given temperature. How

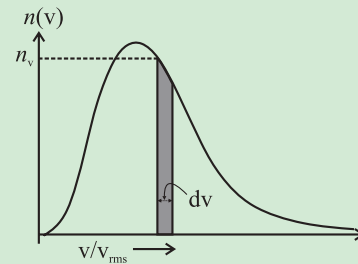

many molecules will have speeds greater or smaller than v_{rms} ? Molecules can have varying speeds in the range zero to infinity. What is the number of molecules having a particular speed in this range? This function, the number of molecules as a function of the speed is known as the distribution of speeds. Figure shows a typical distribution of speeds for a gas at a temperature T . This is known as Maxwell's distribution of molecular speeds. Here, the shaded area $n_v dv$ is the number of molecules having speed between v and $v + dv$. Average values of physical quantities like $\overline{v^2}$ can be calculated once the distribution is known.

$$PV = \frac{2}{3} E \quad \text{--- (3.15)}$$

Using ideal gas equation,

$$PV = Nk_B T = \frac{2}{3} E \quad \text{--- (3.16)}$$

$$\therefore E = \frac{3}{2} Nk_B T \quad \text{--- (3.17)}$$

$$\text{or } \frac{E}{N} = \frac{3}{2} k_B T \quad \text{--- (3.18)}$$

This means that the average energy per molecule is proportional to the absolute temperature T of the gas. This equation relates the macroscopic parameter of the gas, T , to the kinetic energy of a molecule.

Example 3.2: At 300 K, what is the rms speed of Helium atom? [mass of He atom is $4u$, $1u = 1.66 \times 10^{-27}$ kg; $k_B = 1.38 \times 10^{-23}$ J/K]

Solution: Given $T = 300$ K,

$$\begin{aligned} m &= 4 \times 1.66 \times 10^{-27} \text{ kg} \\ \text{Average } K.E. &= \frac{1}{2} m \overline{v^2} = \frac{3}{2} k_B T \\ \therefore \overline{v^2} &= \frac{3k_B T}{m} = \frac{3 \times 1.38 \times 10^{-23} \times 300}{4 \times 1.66 \times 10^{-27}} \\ &= 187.05 \times 10^4 \\ v_{\text{rms}} &= \sqrt{\overline{v^2}} = 13.68 \times 10^2 \\ &= 1368 \text{ m/s} \end{aligned}$$

3.8 Law of Equipartition of Energy:

We have seen that the kinetic energy of a single molecule is

$$K.E. = \frac{1}{2} m v_x^2 + \frac{1}{2} m v_y^2 + \frac{1}{2} m v_z^2$$

For a gas at a temperature T , the average kinetic energy per molecule denoted as $\langle K.E. \rangle$ is

$$\langle K.E. \rangle = \left\langle \frac{1}{2} m v_x^2 \right\rangle + \left\langle \frac{1}{2} m v_y^2 \right\rangle + \left\langle \frac{1}{2} m v_z^2 \right\rangle$$

But we know that the mean energy per molecule is $\frac{3}{2} k_B T$. Since there is no preferred direction x or y or z ,

$$\left\langle \frac{1}{2} m v_x^2 \right\rangle = \left\langle \frac{1}{2} m v_y^2 \right\rangle = \left\langle \frac{1}{2} m v_z^2 \right\rangle = \frac{1}{2} k_B T \quad \text{--- (3.19)}$$

Thus the mean energy associated with every component of translational kinetic energy which is quadratic in the velocity components in x , y and z directions is $\frac{1}{2} k_B T$ and therefore the total translational energy contribution of the molecule is $(3/2)k_B T$.

3.8.1 Degrees of Freedom:

In the above discussion, the molecule as a whole is free to move from one point to the other in the three dimensional space. If it is restricted to move in a plane surface which is two dimensional, then only two coordinates say x and y will be sufficient to describe its location and two components v_x , v_y will describe its motion in the plane. If a

molecule moves along a straight line, then only x coordinate and only one velocity component v_x will be sufficient to describe its location and motion along a straight line.

We say that the molecule is free to execute 3, 2, and 1 dimensional translational motion in the above examples. In other words, the molecule in these examples has 3, 2, and 1 degrees/degree of freedom.

Degrees of freedom of a system are defined as the total number of coordinates or independent quantities required to describe the position and configuration of the system completely.

3.8.2 Diatomic Molecules:

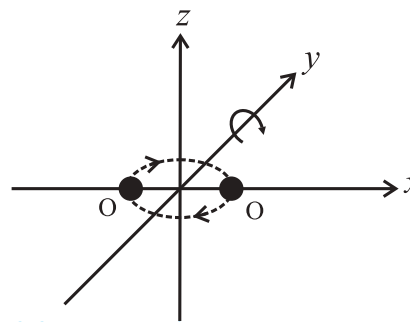

Fig. 3.3: The two independent axes z and y of rotation of a diatomic molecule such as O_2 lying along the x -axis.

Monatomic gas like helium contains He atoms. An He atom has 3 translational degrees of freedom (dof). Consider for example, O_2 or N_2 molecule with the two atoms lying along the x -axis. The molecule has 3 translational dof. In addition, it can rotate around z -axis and y -axis. Figure 3.3 depicts rotation of molecule about the z -axis. Like wise, rotation is possible about the y -axis. (Note that rotation around the x -axis is not a rotation in the sense that it does not involve change of positions of the two atoms of the molecule). In general, a diatomic molecule can rotate about its centre of mass in two directions that are perpendicular to its molecular axis. The molecules like O_2 , are therefore, said to possess 2 additional dof namely 2 rotational dof. Each of these 2 dof contribute to rotational kinetic energy. It can be shown that if I_z and I_y are moments

of inertia about z and y axes with ω_z and ω_y , the respective angular speeds, the rotational kinetic energies will be $\frac{1}{2}I_z\omega_z^2$ and $\frac{1}{2}I_y\omega_y^2$ for rotation around the two axes. Thus for a diatomic molecule, the total energy due to translational and rotational dof is

$$\begin{aligned} E &= E(\text{translational}) + E(\text{rotational}) \\ &= \frac{1}{2}mv_x^2 + \frac{1}{2}mv_y^2 + \frac{1}{2}mv_z^2 \\ &\quad + \frac{1}{2}I_z\omega_z^2 + \frac{1}{2}I_y\omega_y^2 \quad \text{--- (3.20)} \end{aligned}$$

The above expression contains quadratic terms that correspond to various dof of a diatomic molecule. Each of them contributes $\frac{1}{2}k_B T$ to the total energy of the molecule. In the above discussion, an implicit assumption was made that the rotating molecule is a rigid rotator. However, real molecules contain covalent bonds between the atoms and therefore can perform additional motion namely vibrations of atoms about their mean positions like a one-dimensional harmonic oscillator. Such molecules therefore possess additional dof corresponding to the different modes of vibration. In diatomic molecules like O_2 , N_2 and CO , the atoms can oscillate along the internuclear axis only. This motion adds energy associated with the vibrations to the total energy of the molecule.

$$\begin{aligned} E &= E(\text{translational}) + E(\text{rotational}) + \\ &\quad E(\text{vibrational}) \quad \text{--- (3.21)} \end{aligned}$$

The term $E(\text{vibrational})$ consists of two contributions - one from the kinetic energy term and the other from the potential energy term.

$$E(\text{vibrational}) = \frac{1}{2}mu^2 + \frac{1}{2}kr^2 \quad \text{--- (3.22)}$$

where \vec{u} is the velocity of vibrations of the atoms of the molecule, r is the separation between the atoms performing oscillations and k is related to the force constant. The terms in Eq. (3.22) are quadratic in velocity and position respectively and each will contribute

$\frac{1}{2}k_B T$. Thus each mode or dof for vibrational motion contributes $2 \times \frac{1}{2}k_B T$ to the total internal energy.

Hence for a non-rigid diatomic gas in thermal equilibrium at a temperature T , the mean kinetic energy associated with the translational motion of molecule along the three directions is $3 \times \frac{1}{2}k_B T$, the mean kinetic energy associated with the rotational motions about two perpendicular axes is $2 \times \frac{1}{2}k_B T$ and total vibrational energy is $2 \times \frac{1}{2}k_B T$ corresponding to kinetic and potential energy terms. Considering the above facts law of equipartition of energy is stated as: **for a gas in thermal equilibrium at a temperature T , the average energy for molecule associated with each quadratic term is $\frac{1}{2}k_B T$.** The law of equipartition of energy is valid for high temperatures and not for extremely low temperatures where quantum effects become important.

3.9 Specific Heat Capacity:

You know that when the temperature of a gas is increased, even a small rise causes considerable change in volume and pressure. Therefore two specific heats are defined for gases, namely specific heat at constant volume C_v and specific heat at constant pressure C_p . Mayer's relation gives an expression that connects the two specific heats.

3.9.1 Mayer's Relation:

Consider one mole of an ideal gas that is enclosed in a cylinder by light, frictionless airtight piston. Let P , V and T be the pressure, volume and temperature respectively of the gas. If the gas is heated so that its temperature rises by dT , but the volume remains constant, then the amount of heat supplied to the gas, dQ_1 , is used to increase the internal energy of the gas (dE). Since, volume of the gas is constant, no work is done in moving the piston.

$$\therefore dQ_1 = dE = C_V dT \quad \text{--- (3.23)}$$

where C_V is the molar specific heat of the gas at constant volume.

On the other hand, if the gas is heated to the same temperature, at constant pressure, volume of the gas increases by an amount say dV . The amount of heat supplied to the gas is used to increase the internal energy of the gas as well as to move the piston backwards to allow expansion of gas (the work done to move the piston $dW = PdV$)

$$dQ_2 = dE + dW = C_p dT \quad \text{--- (3.24)}$$

where C_p is the molar specific heat of the gas at constant pressure.

But $dE = C_V dT$ from Eq. (3.23) as the internal energy of an ideal gas depends only on its temperature.

$$\therefore C_p dT = C_V dT + dW$$

$$\text{or, } (C_p - C_V) dT = P dV \quad \text{--- (3.25)}$$

For one mole of gas,

$$PV = RT$$

$$\therefore P dV = R dT, \text{ since pressure is constant.}$$

Substituting in Eq. (3.25), we get

$$(C_p - C_V) dT = R dT$$

$$\therefore C_p - C_V = R \quad \text{--- (3.26)}$$

This is known as Mayer's relation between C_p and C_V .

The above relation has been derived assuming that the heat energy and mechanical work are measured in the same units. Generally, heat supplied is measured in calories and work done is measured in joules. The above relation then is modified to $C_p - C_V = R/J$ where J is mechanical equivalent of heat.

Also $C_p = M_0 S_p$ and $C_V = M_0 S_V$, where M_0 is the molar mass of the gas and S_p and S_V are respective principal specific heats. (In many books, c_p and c_v are used to denote the principal specific heats). Thus,

$$M_0 S_p - M_0 S_V = R/J$$

$$\therefore S_p - S_V = \frac{R}{M_0 J} \quad \text{--- (3.27)}$$

Example 3.3: Given the values of the two principal specific heats, $S_p = 3400 \text{ cal kg}^{-1} \text{ K}^{-1}$ and $S_V = 2400 \text{ cal kg}^{-1} \text{ K}^{-1}$ for the hydrogen gas, find the value of J if the universal gas constant $R = 8300 \text{ J kg}^{-1} \text{ K}^{-1}$.

Solution: Given

$$S_p = 3400 \text{ cal kg}^{-1} \text{ K}^{-1},$$

$$S_V = 2400 \text{ cal kg}^{-1} \text{ K}^{-1},$$

$$R = 8300 \text{ J kg}^{-1} \text{ K}^{-1}.$$

$$S_p - S_V = \frac{R}{M_0 J} \text{ from Eq. (3.27)}$$

$$3400 - 2400 = \frac{8300}{2J} \text{ as } M_0 = 2 \text{ for } \text{H}_2 \text{ gas}$$

$$\text{Hence, } J = \frac{8300}{2 \times 1000} = 4.15 \text{ J / cal}.$$

Example 3.4: The difference between the two molar specific heats of a gas is $8000 \text{ J kg}^{-1} \text{ K}^{-1}$. If the ratio of the two specific heats is 1.65, calculate the two molar specific heats.

Solution: Given

$$C_p - C_V = 8000 \text{ J kg}^{-1} \text{ K}^{-1} \text{ and } \frac{C_p}{C_V} = 1.65.$$

$$\therefore C_p = 1.65 C_V \text{ and } 1.65 C_V - C_V = 8000.$$

Solving these, we get

$$C_V = \frac{8000}{0.65} = 12307.69 \text{ J kg}^{-1} \text{ K}^{-1} \text{ and}$$

$$C_p = 8000 + C_V = 20307.69 \text{ J kg}^{-1} \text{ K}^{-1}$$

It is interesting to use the law of equipartition of energy and calculate the specific heat of gases.

(a) Monatomic Gases: For a monatomic gas enclosed in a container, held at a constant temperature T and containing N_A atoms, each atom has only 3 translational dof. Therefore, average energy per atom is $\frac{3}{2} k_B T$ and the total internal energy per mole is

$$E = \frac{3}{2} N_A k_B T$$

\therefore Molar specific heat at constant volume

$$C_V = \frac{dE}{dT} = \frac{3}{2} N_A k_B = \frac{3}{2} R \quad \text{--- (3.28)}$$

$$\text{Using Eq. (3.26), } C_p = \frac{5}{2} R \quad \text{--- (3.29)}$$

$$\therefore \gamma = \frac{C_p}{C_v} = \frac{5}{3} \quad \text{--- (3.30)}$$

(b) Diatomic Gases: For a gas consisting of diatomic molecules such as O_2 , N_2 , CO , HCl , enclosed in a container held at a constant temperature T , if treated as a rigid rotator, each molecule will have 3 translational and 2 rotational dof. According to the law of equipartition of energy, the internal energy of one mole of gas is

$$E = \frac{3}{2} N_A k_B T + \frac{2}{2} N_A k_B T = \frac{5}{2} N_A k_B T$$

The molar specific heat at constant volume will be

$$C_v = \frac{5}{2} N_A k_B = \frac{5}{2} R \quad \text{--- (3.31)}$$

$$\text{Using Eq. (3.26), } C_p = \frac{7}{2} R \quad \text{--- (3.32)}$$

$$\therefore \gamma = \frac{C_p}{C_v} = \frac{7}{5} \quad \text{--- (3.33)}$$

For diatomic gas containing non rigid vibrating molecules, internal energy per mole is

$$\begin{aligned} E &= \frac{3}{2} N_A k_B T + \frac{2}{2} N_A k_B T + \frac{2}{2} N_A k_B T \\ &= \frac{7}{2} N_A k_B T \end{aligned}$$

The molar specific heat at constant volume will be $C_v = \frac{7}{2} N_A k_B = \frac{7}{2} R$ --- (3.34)

$$\text{Using Eq. (3.26), } C_p = \frac{9}{2} R \quad \text{--- (3.35)}$$

$$\therefore \gamma = \frac{C_p}{C_v} = \frac{9}{7} \quad \text{--- (3.36)}$$

(c) Polyatomic Gases : Gases which have molecules containing more than two atoms are termed as polyatomic gases, e.g., ammonia gas where each molecule has one N atom and three H atoms. Each molecule of the polyatomic gas has 3 translational dof. Only linear molecules have 2 dof for rotation. All other polyatomic molecules can perform rotations about three mutually perpendicular axes through their center of mass, hence they have 3 dof for rotation also. Polyatomic molecules have more than 1 dof for different modes of

vibrational motion. The number of dof, f , for the vibrational motion of a polyatomic molecule depends on the geometric structure of the molecule i.e., the arrangement of atoms in a molecule. Each such dof contributes average energy $2 \times \frac{1}{2} k_B T$ from kinetic energy and potential energy terms. Therefore for 1 mole of a polyatomic gas, the internal energy is

$$\begin{aligned} E &= \frac{3}{2} N_A k_B T + \frac{3}{2} N_A k_B T + f \times \frac{2}{2} N_A k_B T \\ &= (3 + f) N_A k_B T \end{aligned}$$

and the molar specific heats at constant volume and constant pressure are given as

$$C_v = (3 + f) R \quad \text{--- (3.37)}$$

$$\text{and } C_p = (4 + f) R \quad \text{--- (3.38)}$$

$$\therefore \gamma = \frac{C_p}{C_v} = \frac{4 + f}{3 + f} \quad \text{--- (3.39)}$$



Can you recall?

1. What are the different modes of transfer of heat?
2. What are electromagnetic waves?
3. Does heat transfer by radiation need a material medium?



Do you know?

If a hot body and a cold body are kept in vacuum, separated from each other, can they exchange heat? If yes, which mode of transfer of heat causes change in their temperatures? If not, give reasons.

3.10 Absorption, Reflection and Transmission of Heat Radiation:

In XIth Std. you have studied that heat can be transferred by conduction, convection and radiation. The first two modes of heat transfer require a material medium for transmission of heat but radiation does not need a material medium. The most common example of heat transfer by the radiation mode that we come across every day is the transfer of heat and light from the Sun to the earth and to us. In this

section, we shall discuss radiation in detail. As the term 'radiation' refers to one mode of transfer of heat, the term 'radiation' also refers to continuous emission of energy from the surface of any body because of its thermal energy. This emitted energy is termed as radiant energy and is in the form of electromagnetic waves. Radiation is therefore the fastest mode of transfer of heat. The process of transfer of heat by radiation does not require any material medium since electromagnetic waves travel through vacuum. Heat transfer by radiation is therefore possible through vacuum as well as through a material medium transparent to this radiation. Physical contact of the bodies that are exchanging heat is also not required. When the radiation falls on a body that is not transparent to it, e.g., on the floor or on our hands, it is absorbed and the body gets heated up. The electromagnetic radiation emitted by the bodies, which are at higher temperature with respect to the surroundings, is known as thermal radiation.

3.10.1 Interaction of Thermal Radiation and Matter:

Whenever thermal radiation falls on the surface of an object, some part of heat energy is reflected, some part is absorbed and the remaining part is transmitted.

Let Q be the total amount of thermal energy incident on the surface of an object and Q_a , Q_r and Q_t be the respective amounts of heat absorbed, reflected and transmitted by the object:

$$\therefore Q = Q_a + Q_r + Q_t;$$

$$\text{dividing by } Q, 1 = \frac{Q_a}{Q} + \frac{Q_r}{Q} + \frac{Q_t}{Q}$$

$$\therefore a + r + t_r = 1 \quad \text{--- (3.40)}$$

where $a \left(= \frac{Q_a}{Q} \right)$, $r \left(= \frac{Q_r}{Q} \right)$ and $t_r \left(= \frac{Q_t}{Q} \right)$ are the coefficients of absorption, reflection and transmission, respectively.

Coefficient of absorption or absorptive power or absorptivity (a): The ratio of amount of heat absorbed to total quantity

of heat incident is called the coefficient of absorption.

Coefficient of reflection or reflectance (r): The ratio of amount of radiant energy reflected to the total energy incident is called the coefficient of reflection.

Coefficient of transmission or transmittance (t_r): The ratio of amount of radiant energy transmitted to total energy incident is called the coefficient of transmission.

Since all the three quantities a , r and t_r are ratios of thermal energies, they are dimensionless quantities.

If $r = 0$ and $a = 0$, then $t_r = 1$, all the incident energy is transmitted through the object i.e., it is a perfect transmitter. The object is said to be completely transparent to the radiation.

A substance through which heat radiations can pass is known as a *diathermanous substance*. For a diathermanous body, $t_r \neq 0$. A diathermanous body is neither a good absorber nor a good reflector.

Examples of diathermanous substances are glass, quartz, sodium chloride, hydrogen, oxygen, dry air etc.

On the other hand, if $t_r = 0$ and $a + r = 1$, i.e., the object does not transmit any radiation, it is said to be opaque to the radiation.

Substances which are largely opaque to thermal radiations i.e., do not transmit heat radiations incident on them, are known as *athermanous substances*.

Examples of athermanous substances are water, wood, iron, copper, moist air, benzene etc.

If $t_r = 0$ and $a = 0$, then $r = 1$, all the incident energy is reflected by the object i.e., it is a perfect reflector. A good reflector is a poor absorber and a poor transmitter.

If $r = 0$ and $t_r = 0$ then $a = 1$, all the incident energy is absorbed by the object. Such an object is called a perfect blackbody. (We will discuss this in detail later in this chapter)

The values of a , r and t_r also depend on the wavelength of the incident radiation, in addition to the material of the object on which it is incident. Hence, it is possible that an object may be athermanous or diathermanous for certain wavelengths, but is a good absorber for certain other wavelengths.

3.11 Perfect Blackbody:

A body, which absorbs the entire radiant energy incident on it, is called an ideal or perfect blackbody. Thus, for a perfect blackbody, $a = 1$. Any surface that absorbs all the energy incident on it, and does not reflect any energy, therefore, appears black (unless its temperature is very high to be self-luminous). Lamp black or platinum black that absorb nearly 97% of incident radiant heat, resemble a perfect blackbody.



Do you know?

- Can a perfect blackbody be realized in practice?
- Are good absorbers also good emitters?

Consider two objects, which are opaque to thermal radiation, having the same temperature and same surface area. The surface of one object is well-polished and the surface of the other object is painted black. The well-polished object reflects most of the energy falling on it and absorbs little. On the other hand, the black painted object absorbs most of the radiation falling on it and reflects little. But the rate of emission of thermal radiation must be equal to rate of absorption for both the objects, so that temperature is maintained. Black painted object absorbs more, hence it must radiate more to maintain the temperature. Therefore, good absorbers are always good emitters and poor absorbers are poor emitters. Since each object must either absorb or reflect the radiation incident on it, a poor absorber should be a good reflector and vice versa. Hence, a good reflector is also a poor emitter. This is the reason for silvering the walls of vacuum bottles or thermos flasks.

For the study of radiation, a simple arrangement illustrated in Fig. 3.4, which was designed by Ferry, can be used as a perfect blackbody.

3.11.1 Ferry's Blackbody:

It consists of a double walled hollow sphere having tiny hole or aperture, through which radiant heat can enter (Fig. 3.4). The space between the walls is evacuated and outer surface of the sphere is silvered. The inner surface of sphere is coated with lamp-black. There is a conical projection on the inner surface of sphere opposite the aperture. The projection ensures that a ray travelling along the axis of the aperture is not incident normally on the surface and is therefore not reflected back along the same path. Radiation entering through the small hole has negligible chance of escaping back through the small hole. A heat ray entering the sphere through the aperture suffers multiple reflections and is almost completely absorbed inside. Thus, the aperture behaves like a perfect blackbody. In a similar construction, Wien used a cylindrical body with a vertical slit as the aperture. This gives greater effective area as a perfect blackbody.

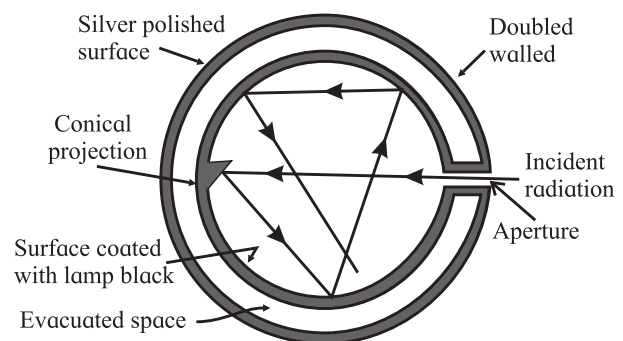

Fig. 3.4: Ferry's blackbody.

Similar working can be achieved using a cavity radiator that consists of a block of material with internal cavity. The inner and outer surfaces are connected by a small hole. The radiation falling on the block that enters through the hole, cannot escape back from it. Hence, the cavity acts as a blackbody. When

the block is heated to high temperature, thermal radiation is emitted. This is called cavity radiation and resembles the radiation emitted by a blackbody. Its nature depends only on the temperature of the cavity walls and not on the shape and size of the cavity or the material of the cavity walls. In the kinetic theory of gases, we discussed the theory, properties and various phenomena of an ideal gas rather than dealing with real gases, similarly it is convenient to work with an ideal blackbody.

3.12 Emission of Heat Radiation :

In 1792, Pierre Prevost published a theory of radiation known as theory of exchange of heat. According to this theory, all bodies at all temperatures above 0 K (absolute zero temperature) radiate thermal energy and at the same time, they absorb radiation received from the surroundings. The amount of thermal radiation emitted per unit time depends on the nature of emitting surface, its area and its temperature. Hotter bodies radiate at higher rate than the cooler bodies. Light coloured bodies reflect most of the visible radiation whereas dark coloured bodies absorb most of the incident visible radiation.

For a body, the absorbed radiation (being energy) increases the kinetic energy of the constituent atoms oscillating about their mean positions. You have learnt earlier that the average translational kinetic energy determines the temperature of the body, the absorbed radiation therefore causes a rise in the temperature of the body. The body itself also radiates, therefore its energy decreases, causing lowering of temperature. If a body radiates more than it absorbs, its temperature decreases and vice versa. When the rate of absorption of radiation is same as the rate of emission of radiation, the temperature of the body remains constant and the body is said to be in thermal equilibrium with its surroundings. You might recall the example

from XIth Std. of a cup of hot tea ($T_{\text{tea}} > T_{\text{room}}$) or a plate containing ice ($T_{\text{ice}} < T_{\text{room}}$) kept on a table, both attain the room temperature after some time. At room temperature also, all bodies radiate as well as absorb radiation, but their rate of emission and rate of absorption are same, hence their temperature remains constant. You can therefore infer that hot bodies would radiate more than cooler bodies.

At room temperature (in fact for temperatures T lower than 800°C), the thermal radiation corresponds to wavelengths longer than those of visible light and hence we do not see them. When the body is heated, the radiated energy corresponds to shorter wavelengths. For temperatures around 800°C , part of the energy emitted is in the visible range and body appears *red*. At around 3000°C , it looks *white hot*. The filament of a tungsten lamp appears white hot as its temperature is around 3000°C

We have thus seen that all bodies radiate electromagnetic radiation when their temperature is above the absolute zero of temperature.

Amount of heat radiated by a body depends on

- The absolute temperature of the body (T)
- The nature of the body – the material, nature of surface – polished or not, etc.
- Surface area of the body (A)
- Time duration of for which body emits radiation (t)

The amount of heat radiated, Q , is directly proportional to the surface area (A) and time duration (t). It is therefore convenient to consider the quantity of heat radiated per unit area per unit time (or power emitted per unit area). This is defined as *emissive power* or *radiant power*, R , of the body, at a given temperature T .

$$\therefore R = \frac{Q}{At}$$

Dimensions of emissive power are $[\text{L}^{\circ}\text{M}^1\text{T}^{-3}]$ and SI unit is $\text{J m}^{-2} \text{s}^{-1}$ or W/m^2 .

The nature of emitting surface, i.e., its

material or polishing is not a physical quantity. Hence, to discuss the material aspect, we compare objects of different materials with identical geometries at the same temperature. At a given temperature, a perfect blackbody has maximum emissive power. Thus it is convenient to compare emissive power of a given surface with that of the perfect blackbody at the same temperature.

3.12.1 Coefficient of Emission or Emissivity:

The coefficient of emission or emissivity (e) of a given surface is the ratio of the emissive power R of the surface to the emissive power R_B of a perfect black surface, at the same temperature.

$$\therefore e = \frac{R}{R_B} \quad \text{--- (3.41)}$$

For a perfect blackbody $e = 1$, whereas for a perfect reflector $e = 0$.



Use your brain power

- Why are the bottoms of cooking utensils blackened and tops polished?
- A car is left in sunlight with all its windows closed on a hot day. After some time it is observed that the inside of the car is warmer than outside air. Why?
- If surfaces of all bodies are continuously emitting radiant energy, why do they not cool down to 0 K?

Everyday objects are not ideal blackbodies. Hence, they radiate at a rate less than that of the blackbody at the same temperature. Also for these objects, the rate does depend on properties such as the colour and composition of the surface, in addition to the temperature. All these effects together are taken care of in the term emissivity e . For an ordinary body, $0 < e < 1$ depending on the nature of the surface, e.g., emissivity of copper is 0.3. Emissivity is larger for rough surfaces and smaller for smooth and polished surfaces. Emissivity also varies with temperature and wavelength of radiation to some extent.

3.13 Kirchhoff's Law of Heat Radiation and its Theoretical Proof:

Kirchhoff's law of thermal radiation deals with wavelength specific radiative emission and absorption by a body in thermal equilibrium. It states that *at a given temperature, the ratio of emissive power to coefficient of absorption of a body is equal to the emissive power of a perfect blackbody at the same temperature for all wavelengths.*

Since we can describe the emissive power of an ordinary body in comparison to a perfect blackbody through its emissivity, Kirchhoff's law can also be stated as follows: *for a body emitting and absorbing thermal radiation in thermal equilibrium, the emissivity is equal to its absorptivity.*

Symbolically, $a = e$ or more specifically $a(\lambda) = e(\lambda)$.

Thus, if a body has high emissive power, it also has high absorptive power and if a body has low emissive power, it also has low absorptive power.

Kirchhoff's law can be theoretically proved by the following thought experiment. Consider an ordinary body A and a perfect blackbody B of identical geometric shapes placed in an enclosure. In thermal equilibrium, both bodies will be at same temperature as that of the enclosure.

Let R be the emissive power of body A, R_B be the emissive power of blackbody B and a be the coefficient of absorption of body A. If Q is the quantity of radiant heat incident on each body in unit time and Q_a is the quantity of radiant heat absorbed by the body A, then $Q_a = aQ$. As the temperatures of the body A and blackbody B remain the same, both must emit the same amount as they absorb in unit time. Since emissive power is the quantity of heat radiated from unit area in unit time, we can write

Quantity of radiant heat absorbed by body A = Quantity of heat emitted by body A

$$\text{or, } a Q = R \quad \text{--- (3.42)}$$

For the perfect blackbody B,

$$Q = R_B \quad \text{--- (3.43)}$$

Dividing Eq. (3.42) by Eq.(3.43), we get

$$a = \frac{R}{R_B}$$

$$\text{or, } \frac{R}{a} = R_B \quad \text{--- (3.44)}$$

$$\text{But } \frac{R}{R_B} = e \text{ from Eq. (3.41), } \therefore a = e.$$

Hence, Kirchhoff's law is theoretically proved. Can you give two applications of Kirchhoff's law in daily life?

3.14 Spectral Distribution of Blackbody Radiation:

The radiant energy emitted per unit area per unit time by a blackbody depends on its temperature. Hot objects radiate electromagnetic radiation in a large range of frequencies. Hence, the rate of emission per unit area or power per unit area of a surface is defined as a function of the wavelength λ of the emitted radiation. At low temperature, the power radiated is small and primarily lies in the long wavelength region. As the temperature is increased, rate of emission increases fast. At each temperature, the radiant energy contains a mixture of different wavelengths. At higher temperatures, the total energy radiated per unit time increases and the proportion of energy emitted at higher frequencies or shorter wavelengths also increases.

Lummer and Pringsheim studied the energy distribution of blackbody radiation as a function of wavelength. They kept the source of radiation (such as a cavity radiator) at different temperatures and measured the radiant power corresponding to different wavelengths. The measurements were represented graphically in the form of curves showing variation of radiant power per unit area as a function of wavelength λ at different constant temperatures as shown in Fig. 3.5. Spectral distribution of power radiated by a body

indicates the power radiated at different wavelengths. Experimental observations indicated that the spectral distribution depended only on the absolute temperature T of a blackbody and was independent of the material.

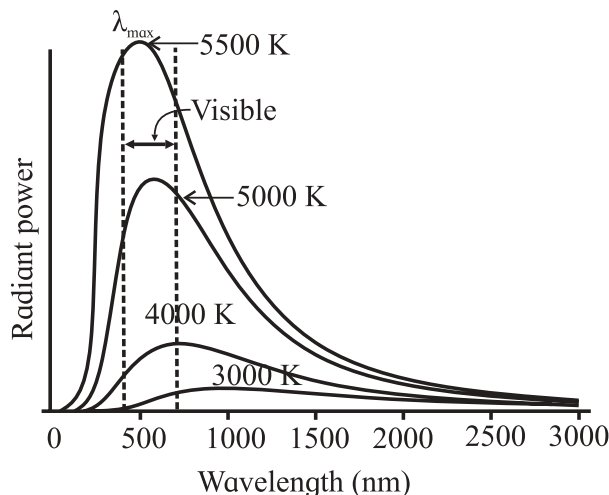

Fig. 3.5: Radiant power of a blackbody per unit range of wavelength as a function of wavelength.

From experimental curves, it is observed that

1. at a given temperature, the energy is not uniformly distributed in the spectrum (i.e., as a function of wavelength) of blackbody,
2. at a given temperature, the radiant power emitted initially increases with increase of wavelength, reaches its maximum and then decreases. The wavelength corresponding to the radiation of maximum intensity, λ_{\max} , is characteristic of the temperature of the radiating body. (Remember, it is not the *maximum wavelength* emitted by the object),
3. area under the curve represents total energy emitted per unit time per unit area by the blackbody at all wavelengths,
4. the peak of the curves shifts towards the left – shorter wavelengths, i.e., the value of λ_{\max} decreases with increase in temperature,
5. at higher temperatures, the radiant power or total energy emitted per unit time per unit area (i.e., the area under the curve)

corresponding to all the wavelengths increases,

6. at a temperature of 300 K (around room temperature), the most intense of these waves has a wavelength of about 5×10^{-6} m; the radiant power is smaller for wavelengths different from this value. Practically all the radiant energy at this temperature is carried by waves longer than those corresponding to red light. These are infrared radiations.

A theoretical explanation of the above observations could not be given by the then existing theories. Wien gave an expression for spectral distribution from laws of thermodynamics, which fitted the experimental observations only for short wavelengths. Lord Rayleigh and Sir James Jeans gave a formula from the equipartition of energy. This formula fits well in the long wavelength regions but tends to infinity at short wavelengths. It was therefore essential to propose a new model to explain the behaviour of blackbody. Planck, being aware of the shortcomings of the two models, combined the two models using an empirical formula and could describe the observed spectrum quite well.



Do you know?

The idea of quantization of energy was first proposed by Planck to explain the blackbody spectrum or the cavity radiations. Planck proposed a model in terms of the atomic processes. He considered the atoms of the walls of the cavity as tiny electromagnetic oscillators with characteristic frequencies that exchange energy with the cavity. This energy was supposed to have only specific values $E = nh\nu$, where ν is the frequency of oscillator, h is a universal constant that has a value 6.626×10^{-34} J s and n can take only positive integral values. The oscillators would not radiate energy continuously but only in “jumps” or “quanta” corresponding to transitions from one quantized level of

energy to another of lower energy. As long as the oscillator is in one of the quantized states, it does not emit or absorb energy. This model of Planck turned out to be the basis for Einstein’s theory to explain the observations of experiments on photoelectric effect, as you will learn in Chapter 14.

3.14.1 Wien’s Displacement Law :

It is observed that the wavelength, for which emissive power of a blackbody is maximum, is inversely proportional to the absolute temperature of the blackbody. This is Wien’s displacement law.

$$\lambda_{max} \propto \frac{1}{T}$$

$$\text{or, } \lambda_{max} = \frac{b}{T}$$

$$\therefore \lambda_{max} T = b \quad \text{--- (3.45)}$$

where b is called the Wien’s constant and its value is 2.897×10^{-3} m K. λ_{max} indicates the wavelength at which the blackbody dominantly radiates. Thus, it corresponds to the dominant colour of the radiating body and is a function of its temperature. You might have heard of white dwarfs and red giants, white dwarfs are hot stars with surface temperature ~ 10000 K while red giants are cooler corresponding to surface temperature ~ 3000 K.

This law is useful to determine temperatures of distant stars, Sun, moon etc.

Example 3.5: Calculate the value of λ_{max} for solar radiation assuming that surface temperature of Sun is 5800 K ($b = 2.897 \times 10^{-3}$ m K). In which part of the electromagnetic spectrum, does this value lie?

Solution: Given

$T = 5800$ K and $b = 2.897 \times 10^{-3}$ m K.

Using Eq. (3.45),

$$\lambda_{max} = \frac{2.897 \times 10^{-3} \text{ m K}}{5800 \text{ K}}$$

$$= 4.995 \times 10^{-7} \text{ m} = 4995 \text{ \AA}$$

This value lies in the visible region of the electromagnetic spectrum.

**Can you tell?**

λ_{max} , the wavelength corresponding to maximum intensity for the Sun is in the blue-green region of visible spectrum. Why does the Sun then appear yellow to us?

3.15 Stefan-Boltzmann Law of Radiation:

We shall now discuss the temperature dependence of thermal radiation emitted per unit time by a blackbody. In 1879, Josef Stefan proposed an empirical relation between the rate at which heat is radiated (the radiant power R) from unit area of a perfect blackbody and its temperature T , based on the experimental observations. Five years later, Boltzmann derived the relation using thermodynamics. Hence it is known as Stefan-Boltzmann law. According to this law, “The rate of emission of radiant energy per unit area or the power radiated per unit area of a perfect blackbody is directly proportional to the fourth power of its absolute temperature”.

$$R \propto T^4$$

$$\text{or, } R = \sigma T^4 \quad \text{--- (3.46)}$$

where σ is Stefan’s constant and is equal to $5.67 \times 10^{-8} \text{ J m}^{-2} \text{ s}^{-1} \text{ K}^{-4}$ or $\text{W m}^{-2} \text{ K}^{-4}$ and dimensions of σ are $[\text{L}^0 \text{M}^1 \text{T}^{-3} \text{K}^{-4}]$.

Thus, the power radiated by a perfect blackbody depends only on its temperature and not on any other characteristics such as colour, materials, nature of surface etc.

If Q is the amount of radiant energy emitted in time t by a perfect blackbody of surface area A at temperature T , then $\frac{Q}{At} = \sigma T^4$.

For a body, which is not a blackbody, the energy radiated per unit area per unit time is still proportional to the fourth power of temperature but is less than that for the blackbody. For an ordinary body,

$$R = e\sigma T^4 \quad \text{--- (3.47)}$$

where e is emissivity of the surface.

If the perfect blackbody having absolute temperature T is kept in a surrounding which is at a lower absolute temperature T_0 , then

the energy radiated per unit area per unit time = σT^4

Energy absorbed from surroundings per unit area per unit time = σT_0^4

Therefore net loss of energy by perfect blackbody per unit area per unit time = $\sigma T^4 - \sigma T_0^4 = \sigma(T^4 - T_0^4)$.

For an ordinary body, net loss of energy per unit area per unit time = $e\sigma(T^4 - T_0^4)$.

On the other hand, if the body is at a temperature lower than the surrounding i.e., $T < T_0$, then $e\sigma(T_0^4 - T^4)$ will be the net gain in thermal energy of the body per unit area per unit time.

Since the loss or gain of energy per unit area per unit time is proportional to the fourth power of absolute temperature, this law is very significant in deciding the thermal equilibrium of physical systems. If the absolute temperature of a body is doubled, the power radiated will increase by a factor of $2^4 = 16$. Or if a body radiates with some rate at room temperature (300 K), the rate will double even if we increase the temperature of the body by 57 °C.

Example 3.6: Calculate the energy radiated in one minute by a blackbody of surface area 200 cm² at 127 °C ($\sigma = 5.7 \times 10^{-8} \text{ J m}^{-2} \text{ s}^{-1} \text{ K}^{-4}$).

Solution: Given

$$A = 200 \text{ cm}^2 = 200 \times 10^{-4} \text{ m}^2,$$

$$T = 127 \text{ °C} = (127 + 273) \text{ K} = 400 \text{ K},$$

$$t = 1 \text{ min} = 60 \text{ s}$$

We know that energy radiated is given by

$$Q = \sigma A t T^4$$

$$= 5.7 \times 10^{-8} \times 200 \times 10^{-4} \times 60 \times (400)^4$$

$$= 5.7 \times 1.2 \times 256$$

$$= 1751.04 \text{ J}$$

Example 3.7: A 60 watt filament lamp loses all its energy by radiation from its surface. The emissivity of the surface is 0.5. The area of the surface is $5 \times 10^{-5} \text{ m}^2$. Find the temperature of the filament ($\sigma = 5.67 \times 10^{-8} \text{ J m}^{-2} \text{ s}^{-1} \text{ K}^{-4}$).

Solution: Given, $e = 0.5$, $A = 5 \times 10^{-5} \text{ m}^2$,
 $\frac{dQ}{dt} = 60 \text{ W} = 60 \text{ J s}^{-1}$

We know that $\frac{dQ}{dt} = e\sigma AT^4$

$$\therefore 60 = 0.5 \times 5.67 \times 10^{-8} \times 5 \times 10^{-5} \times T^4$$

$$\therefore T^4 = \frac{60 \times 10^{13}}{5.67 \times 2.5}$$

$$T^4 = 4.23 \times 10^{13}$$

$$\therefore T = (42.3 \times 10^{12})^{1/4}$$

$$T = 2.55 \times 10^3 = 2550 \text{ K}$$

Example 3.8: Compare the rate of loss of heat from a metal sphere at 827°C with the rate of loss of heat from the same sphere at 427°C , if the temperature of the surrounding is 27°C .

Solution: Given,

$$T_1 = 827^\circ\text{C} = 827 + 273 = 1100 \text{ K},$$

$$T_2 = 427^\circ\text{C} = 427 + 273 = 700 \text{ K and}$$

$$T_0 = 27^\circ\text{C} = 27 + 273 = 300 \text{ K}$$

$$R_1 = \left(\frac{dQ}{dt}\right)_1 = e\sigma A(T_1^4 - T_0^4)$$

$$R_2 = \left(\frac{dQ}{dt}\right)_2 = e\sigma A(T_2^4 - T_0^4)$$

$$\therefore \frac{R_1}{R_2} = \frac{(T_1^4 - T_0^4)}{(T_2^4 - T_0^4)} = \frac{1100^4 - 300^4}{700^4 - 300^4}$$

$$\text{or, } \frac{R_1}{R_2} = \frac{14560}{2320} = \frac{182}{29}$$

$$\therefore R_1 : R_2 = 182 : 29$$

Example 3.9: Assuming that the temperature at the surface of the Sun is 6000 K , find out the size of a virtual star (in terms of the size of Sun) whose surface temperature is 3000 K and the power radiated by the virtual star is 25 times the power radiated by the Sun. Treat both, the Sun and virtual star as a blackbody.

Solution: Given,

$$T_{\text{Sun}} = 6000 \text{ K},$$

$$T_{\text{star}} = 3000 \text{ K},$$

$$P_{\text{star}} = 25 \times P_{\text{Sun}}$$

Power radiated by the Sun

$$= P_{\text{Sun}} = \left(\frac{dQ}{dt}\right)_{\text{Sun}} = \sigma A_{\text{Sun}} T_{\text{Sun}}^4 = \sigma 4\pi r_{\text{Sun}}^2 T_{\text{Sun}}^4$$

Power radiated by the virtual star

$$= P_{\text{star}} = \left(\frac{dQ}{dt}\right)_{\text{star}} = \sigma A_{\text{star}} T_{\text{star}}^4 = \sigma 4\pi r_{\text{star}}^2 T_{\text{star}}^4$$

$$\therefore \frac{P_{\text{star}}}{P_{\text{Sun}}} = \frac{\sigma 4\pi r_{\text{star}}^2 T_{\text{star}}^4}{\sigma 4\pi r_{\text{Sun}}^2 T_{\text{Sun}}^4} = \frac{r_{\text{star}}^2 3000^4}{r_{\text{Sun}}^2 6000^4} = 25$$

$$\therefore \frac{r_{\text{star}}^2}{r_{\text{Sun}}^2} = 25 \times \frac{6000^4}{3000^4} = 400$$

$$\text{or, } r_{\text{star}} = 20 \times r_{\text{Sun}}$$



Internet my friend

- <https://www.britannica.com/science/kinetic-theory-of-gases>
- https://www.youtube.com/watch?v=XrAktUy3_3k
- <https://www.youtube.com/watch?v=3tD7ZuqaZik>
- <https://www.youtube.com/watch?v=7BXvc9W97iU>
- [https://chem.libretexts.org/Bookshelves/Physical_and_Theoretical_Chemistry_Textbook_Maps/Map%3A_Physical_Chemistry_\(McQuarrie_and_Simon\)/01%3A_The_Dawn_of_the_Quantum_Theory/1.01%3A_Blackbody_Radiation_Cannot_Be_Explained_Classically](https://chem.libretexts.org/Bookshelves/Physical_and_Theoretical_Chemistry_Textbook_Maps/Map%3A_Physical_Chemistry_(McQuarrie_and_Simon)/01%3A_The_Dawn_of_the_Quantum_Theory/1.01%3A_Blackbody_Radiation_Cannot_Be_Explained_Classically)
- <http://hyperphysics.phy-astr.gsu.edu/hbase/Kinetic/kinthe.html>
- <https://www.youtube.com/watch?v=Qsa4aAdpHfy>
- <https://www.youtube.com/watch?v=buPuKAcKqZw>

**Exercises****1. Choose the correct option.**

- i) In an ideal gas, the molecules possess
 (A) only kinetic energy
 (B) both kinetic energy and potential energy
 (C) only potential energy
 (D) neither kinetic energy nor potential energy
- ii) The mean free path λ of molecules is given by
 (A) $\sqrt{\frac{2}{\pi n d^2}}$ (B) $\frac{1}{\pi n d^2}$
 (C) $\frac{1}{\sqrt{2\pi n d^2}}$ (D) $\frac{1}{\sqrt{2\pi n d}}$,
 where n is the number of molecules per unit volume and d is the diameter of the molecules.
- iii) If pressure of an ideal gas is decreased by 10% isothermally, then its volume will
 (A) decrease by 9%
 (B) increase by 9%
 (C) decrease by 10%
 (D) increase by 11.11%
- iv) If $a = 0.72$ and $r = 0.24$, then the value of t_r is
 (A) 0.02 (B) 0.04 (C) 0.4 (D) 0.2
- v) The ratio of emissive power of perfectly blackbody at 1327 °C and 527 °C is
 (A) 4:1 (B) 16 : 1 (C) 2 : 1 (D) 8 : 1

2. Answer in brief.

- i) What will happen to the mean square speed of the molecules of a gas if the temperature of the gas increases?
- ii) On what factors do the degrees of freedom depend?
- iii) Write ideal gas equation for a mass of 7 g of nitrogen gas.
- iv) If the density of oxygen is 1.44 kg/m³ at a pressure of 10⁵ N/m², find the root mean square velocity of oxygen molecules.
- v) Define athermanous substances and diathermanous substances.
3. When a gas is heated its temperature increases. Explain this phenomenon based on kinetic theory of gases.
4. Explain, on the basis of kinetic theory, how the pressure of gas changes if its volume is reduced at constant temperature.
5. Mention the conditions under which a real gas obeys ideal gas equation.
6. State the law of equipartition of energy and hence calculate molar specific heat of mono- and di-atomic gases at constant volume and constant pressure.
7. What is a perfect blackbody ? How can it be realized in practice?
8. State (i) Stefan-Boltzmann law and (ii) Wein's displacement law.
9. Explain spectral distribution of blackbody radiation.
10. State and prove Kirchoff's law of heat radiation.
11. Calculate the ratio of mean square speeds of molecules of a gas at 30 K and 120 K.
 [Ans: 1:4]
12. Two vessels A and B are filled with same gas where volume, temperature and pressure in vessel A is twice the volume, temperature and pressure in vessel B. Calculate the ratio of number of molecules of gas in vessel A to that in vessel B.
 [Ans: 2:1]
13. A gas in a cylinder is at pressure P. If the masses of all the molecules are made one third of their original value and their speeds are doubled, then find the resultant pressure.
 [Ans: 4/3 P]

14. Show that rms velocity of an oxygen molecule is $\sqrt{2}$ times that of a sulfur dioxide molecule at S.T.P.
15. At what temperature will oxygen molecules have same rms speed as helium molecules at S.T.P.? (Molecular masses of oxygen and helium are 32 and 4 respectively)
[Ans: 2184 K]
16. Compare the rms speed of hydrogen molecules at 127 °C with rms speed of oxygen molecules at 27 °C given that molecular masses of hydrogen and oxygen are 2 and 32 respectively.
[Ans: 8: $\sqrt{3}$]
17. Find kinetic energy of 5 litre of a gas at S.T.P. given standard pressure is 1.013×10^5 N/m².
[Ans: 0.7597]
18. Calculate the average molecular kinetic energy (i) per kmol (ii) per kg (iii) per molecule of oxygen at 127 °C, given that molecular weight of oxygen is 32, R is $8.31 \text{ J mol}^{-1} \text{ K}^{-1}$ and Avogadro's number N_A is 6.02×10^{23} molecules mol⁻¹.
[Ans: $4.986 \times 10^6 \text{ J}$, $1.56 \times 10^2 \text{ J}$, $8.28 \times 10^{-21} \text{ J}$]
19. Calculate the energy radiated in one minute by a blackbody of surface area 100 cm² when it is maintained at 227 °C.
[Ans: 2126.25 J]
20. Energy is emitted from a hole in an electric furnace at the rate of 20 W, when the temperature of the furnace is 727 °C. What is the area of the hole? (Take Stefan's constant σ to be $5.7 \times 10^{-8} \text{ J s}^{-1} \text{ m}^{-2} \text{ K}^{-4}$)
[Ans: $3.5 \times 10^{-4} \text{ m}^2$]
21. The emissive power of a sphere of area 0.02 m² is $0.5 \text{ kcal s}^{-1} \text{ m}^{-2}$. What is the amount of heat radiated by the spherical surface in 20 second?
[Ans: 0.2 kcal]
22. Compare the rates of emission of heat by a blackbody maintained at 727 °C and at 227 °C, if the blackbodies are surrounded by an enclosure (black) at 27 °C. What would be the ratio of their rates of loss of heat?
[Ans: 18.23:1]
23. Earth's mean temperature can be assumed to be 280 K. How will the curve of blackbody radiation look like for this temperature? Find out λ_{max} . In which part of the electromagnetic spectrum, does this value lie?
[Ans: $1.035 \times 10^{-5} \text{ m}$, microwave region]
24. A small-blackened solid copper sphere of radius 2.5 cm is placed in an evacuated chamber. The temperature of the chamber is maintained at 100 °C. At what rate energy must be supplied to the copper sphere to maintain its temperature at 110 °C? (Take Stefan's constant σ to be $5.76 \times 10^{-8} \text{ J s}^{-1} \text{ m}^{-2} \text{ K}^{-4}$ and treat the sphere as blackbody.)
[Ans: 0.962 W]
25. Find the temperature of a blackbody if its spectrum has a peak at (a) $\lambda_{\text{max}} = 700 \text{ nm}$ (visible), (b) $\lambda_{\text{max}} = 3 \text{ cm}$ (microwave region) and (c) $\lambda_{\text{max}} = 3 \text{ m}$ (FM radio waves) (Take Wien's constant $b = 2.897 \times 10^{-3} \text{ m K}$).
[Ans: (a) 4138 K, (b) 0.0966 K, (c) $0.966 \times 10^{-3} \text{ K}$]

4. Thermodynamics



Can you recall?

1. When a piece of ice is placed in water at room temperature, the ice melts and water cools down. Why does their temperature change?
2. When water boils, why does its temperature remains constant?
3. When an inflated balloon is suddenly burst, why is the emerging air slightly cooled?

4.1 Introduction:

In XIth Std. we have studied thermal properties of matter. In this chapter, we shall study the laws that govern the behavior of thermal energy. We shall study the processes where work is converted into heat and vice versa.

When we drive a vehicle, its engine gets warmer after some time. Similarly, when we exercise, we also feel warmth in our body. Similar physics is involved in both the cases. The engine of a vehicle as well as our muscles do some work and both produce some heat. It is, therefore, natural to think that if the work done by an engine or our muscles produces some heat then heat should also be able to 'do' some work. Thermodynamics is mostly the study of conversion of work (or any form of energy) into heat and the other way round.

When a hot object is in contact with a cold object, we notice that both objects reach the same temperature after some time. The hot object gets cooler and the cold object becomes warmer. That means something is exchanged between the two objects. *This 'something' is heat. According to modern theory, heat is a form of energy.*

In the year 1798 it was observed by Benjamin Thomson, a British scientist, that tremendous heat is produced when brass canons were bored. The heat thus produced

was large enough to boil water. A very important observation was that the amount of heat produced was related to the work done in turning the drill that was used to bore the canon. *It was also noticed that more heat was produced when the drill bored for a longer time.* It did not depend on the sharpness of the drills used. A sharper drill would have removed more heat according to the older theory of heat, which assumed heat to be some form of a fluid. This observation could be explained only if heat was a form of energy and not any fluid. It is natural to conclude from these observations that energy can be converted from one form to another form. In this particular case, a very important law of physics can be proposed that, *'the work done by a system is converted into heat'*. (The drills used to bore the canons 'do' the work and the canons get heated up).

This was, probably, one of the pioneer experiments in thermodynamics. *Thermodynamics is the branch of physics that deals with the concepts of heat and temperature and the inter-conversion of heat and other forms of energy.*

It is the field of study that allows us to understand nature of many of the fundamental interactions in the universe. It can explain phenomena as simple as water boiling in a vessel, and also something as complex as the creation of a new star. Thermodynamics is an important branch of physics having many practical applications.

In this chapter we will try to understand a thermodynamic system, thermodynamic variables, thermodynamic processes and the laws that govern these processes. We will also study the most important and useful applications of thermodynamics, the heat engines and their efficiency.

4.2 Thermal Equilibrium:

The thermal properties of materials discussed in XIth Std. are useful to understand the behaviour of a material when it is heated or cooled. When you put a piece of ice in water at room temperature, the ice melts. This is because the water at room temperature (higher than the ice temperature) transfers its heat to ice and helps ice melt. Similarly, when hot water is mixed with cold water, it transfers its heat to the cold water. The hot water cools down. In both these examples, we notice that the two components reach a stage where there is no more transfer of heat. In such cases, we assume that *heat is something that is transferred from a substance at a higher temperature to that at a lower temperature*. This transfer continues till the level of heat content in both the substances is the same. Then we say that a *thermal equilibrium* is reached between the two substances. We can say that *when two objects are at the same temperature, they are in thermal equilibrium*. This concept of thermal equilibrium is used in the Zeroth Law of thermodynamics. It is called the Zeroth Law because it was proposed after the First and the Second laws of thermodynamics were formulated.



Remember this

Thermal equilibrium: Two systems in thermal contact with each other are in thermal equilibrium if they do not transfer heat between each other.



Can you tell?

Why different objects kept on a table at room temperature do not exchange heat with the table?

4.3 Zeroth Law of Thermodynamics:

The Zeroth law is very important as it helps us to define the concept of a temperature scale. The formal statement of the Zeroth law of thermodynamics is as follows:

"If two systems are each in thermal equilibrium with a third system, they are also in thermal equilibrium with each other".

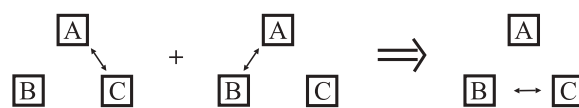

Fig. 4.1: Schematic representation of Zeroth law of thermodynamics.

Figure 4.1 shows a schematic representation of the Zeroth law of thermodynamics. The double arrow represents thermal equilibrium between systems. If system A and C are in thermal equilibrium, and systems A and B are in thermal equilibrium, then systems B and C must be in thermal equilibrium. Then systems A, B and C are at the same temperature.

For example, when we use a thermometer to measure temperature of an object, we use the same principle. When the thermometer and the object are in thermal equilibrium, the thermometer indicates the temperature of the object. The zeroth law, therefore, enables us to use a thermometer to compare the temperatures of different objects. This is schematically shown in the Fig 4.2. It also implies that temperature is a measurable quantity. The science of measuring temperatures is called *Thermometry* which involves different temperature scales and methods of measuring temperature. This is already discussed in XIth Std.

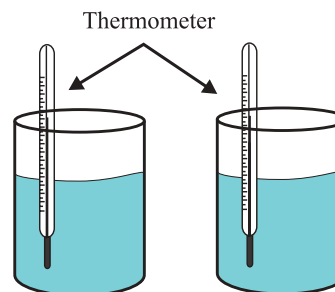

Fig. 4.2: Concept of temperature measurement.



Remember this

The Zeroth Law of Thermodynamics states that systems in thermal equilibrium are at the same temperature.

**Can you tell?**

Why is it necessary to make a physical contact between a thermocouple and the object for measuring its temperature?

4.4 Heat, Internal Energy and Work:

Earlier in this chapter, we saw that when two substances, initially at different temperatures, are brought in contact with each other, the substance at higher temperature loses its heat and the substance at lower temperature gains it. We did not discuss the reasons why any substances can 'have' that heat and what exactly is the nature of the heat content of that substance. The examples we discussed in the previous section and in chapter 7 (XIth Std.), help us understand the transfer of heat from one body to the other. But they do not help us in explaining why the action of rubbing our palms together generates warmth, or why an engine gets warmer when it is running. These and similar phenomena can be explained on the basis of the concept of the internal energy of a system, the conversion of work and heat into each other and the laws governing these inter conversions.

4.4.1 Internal Energy:

We know that every system (large or small) consists of a large number of molecules. *Internal energy is defined as the energy associated with the random, disordered motion of the molecules of a system.* It is different than the macroscopic ordered energy of a moving object. For example, a glass of water kept on a table has no kinetic energy because it is not moving. Its potential energy can also be taken as zero. But we know, from the kinetic theory, that the water molecules in the glass at the given temperature move at a random speed. Thus, we can say that, the internal energy of a substance is the total energy of all its atoms/molecules.

For an ideal monatomic gas such as argon, the internal energy is just the translational

kinetic energy of the atoms having a linear motion. (Discussed in Chapter 3). For a polyatomic gas such as carbon di-oxide, we consider the rotational and vibrational kinetic energy of the molecules in addition to their translational kinetic energy. In case of liquids and solids, we need to consider the potential energy of the molecules due to the intermolecular attractive forces amongst them. Remember this is again at the molecular level (microscopic scale) only. This internal energy of a system is denoted by U .

Example 4.1: Calculate the internal energy of argon and oxygen.

Solution: Argon is a monatomic gas. Internal energy of a gas depends only on its temperature. Hence, its internal energy is given by $3/2 kT$. Oxygen is a dia-atomic gas its internal energy is $5/2 kT$.

4.4.2 Thermodynamic system and Thermodynamic Process:

Figure 4.3 (a): a system, its boundary and environment.

Let us understand what is meant by a thermodynamic system and a thermodynamic process first.

A thermodynamic system is a collection or a group of objects that can form a unit which may have ability to exchange energy with its surroundings. Anything that is not a part of the system is its surrounding or its environment. For example, water kept in a vessel is a system, the vessel is its boundary and the atmosphere around it is its surrounding. Figure 4.3 (a) shows this schematically.

Thermodynamic systems can be classified on the basis of the possible transfer of heat and matter to environment. Based on this, they are

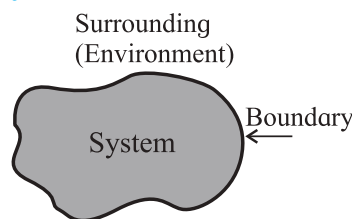
classified as open, closed or isolated systems.

An open system is a system that freely allows exchange of energy and matter with its environment. For example, water boiling in a kettle is an open system. Heat escapes into the air. This is the exchange of energy with the surroundings. At the same time, steam also escapes into the air. This is exchange of matter with the surroundings.

A closed system, on the other hand, does not allow the exchange of matter but allows energy to be transferred. For example, water boiling in a boiler is a closed system. It allows heat (energy) to be transferred from the source of heat (a burner) to the water (system) inside. Similarly, heat is also transferred to the surroundings. Steam (matter) is not allowed to escape as long as the valve is kept closed.

An isolated system is completely sealed (isolated from its environment). Matter as well as heat cannot be exchanged with its environment. A thermos flask is a very familiar example of an isolated system.

Figure 4.3 (b) shows an open system, a closed system, and an isolated system schematically.

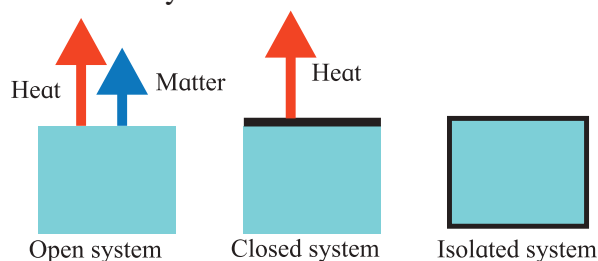

Figure 4.3 (b): Thermodynamic systems; open system, closed system, and isolated system.

A thermodynamic process is a process in which the thermodynamic state of a system is changed. For example, water contained in a vessel with a lid on it is an open system. When the pot is heated externally, water starts boiling after some time and steam is produced which exerts pressure on the walls of the vessel. In this case, the state of the water in the container is changed. This is because, the temperature (T), the volume (V), and the pressure (P) of

the water inside the vessel change when it starts boiling. Thus, we can describe the state of a system by using temperature, pressure and volume as its variables. We will discuss these in some details at a later stage in section 4.5.1.

4.4.3 Heat:

Let us now try to understand heat and its relation with the internal energy of a system. Consider a glass filled with water on a table. The glass, along with the water in it forms a system. Let the temperature of this system be T_S . The table on which the glass is kept and the other relevant parts of the room will then be its surrounding or the environment. Let the temperature of the environment be T_E . We notice that if T_S and T_E are not the same, then T_S will change until both the temperatures are equal and a thermal equilibrium will be reached between the 'system' and the 'environment'. T_S will also change to some extent, but the end result is that the 'system' and the 'environment' reach thermal equilibrium. If the environment is very large, the change in T_E may not be measurable, but certainly not zero.

Such a change in temperature is caused by the transfer of internal energy between the system and its environment. In this case, the transfer of energy is between the glass of water and its surrounding.



Remember this

When transfer of energy takes place between a system and its environment, we observe the following conventions.

1. When the energy is transferred to a system from its environment, it is positive. We say that the system gains (or absorbs) energy.
2. When the energy is transferred from the system to its environment, it is negative. We say that the system loses (or releases) energy.

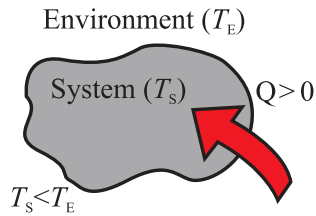

Fig. 4.4 (a): Energy flows into the system.

Consider Fig. 4.4 which shows energy transfer between a system and its environment. Let T_S and T_E be the temperatures of the system and its environment respectively. Let Q be the energy transferred between the system and its environment. As shown in Fig. 4.4 (a), $T_S > T_E$, the system gains energy, and Q is positive.

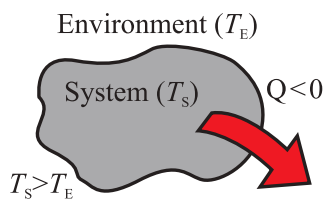

Fig. 4.4 (b): Energy flows from the system.

In Fig. 4.4 (b), $T_S < T_E$ the system loses energy, and Q is negative. In Fig.4.4 (c), $T_S = T_E$, the system and the environment are in thermal equilibrium and there is no transfer of energy ($Q = 0$).

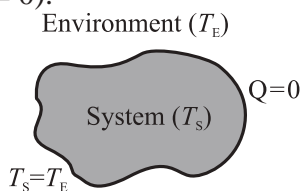

Fig. 4.4 (c): No transfer energy.

Using these observations, we can now define heat as the energy that is transferred (between the system and its environment) due to a temperature difference that exists between the two. It is denoted by Q .

4.4.4 Change in Internal Energy of a System:

In the previous discussion we have seen that the internal energy of a system can be changed (it can be gained or released) due to exchange with its environment. Now we will try to understand how this transfer of energy between a system and its environment is possible. Consider the following experiment. Figure 4.5 (a) shows a cylinder filled with

some gas in it. This cylinder is provided with a movable, massless, and frictionless piston at one end as shown. The gas inside the cylinder is our system and the rest is its environment. Let the temperature of the gas be T_S and that of the environment be T_E .

Internal energy of the system (the gas) can be changed in two different ways or by both.

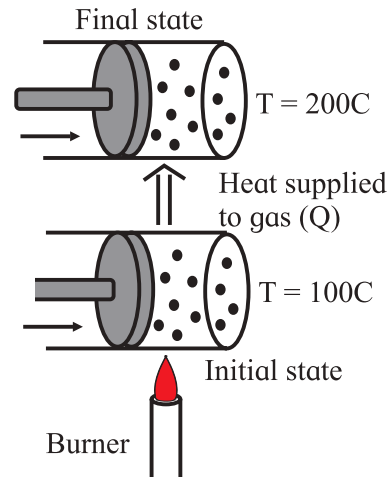

Fig. 4.5: (a) Change in internal energy of a system can be brought about by heating the system.

i) The cylinder can be brought in contact with a source of heat such as a burner as shown in Fig. 4.5.(a). As discussed previously, the temperature difference between the source of heat (environment) and the system will cause a flow of energy (heat) towards the gas in the cylinder. This is because $T_E > T_S$. Thus, there will be an increase in the internal energy of the gas. Such exchange of energy is possible in another way also. If the surrounding is at temperature lower than the gas, $T_S > T_E$, the gas will lose energy to its environment and cool down.

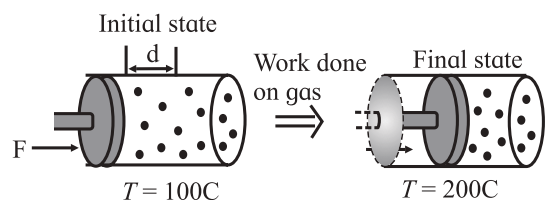

Fig. 4.5: (b) Change in internal energy of a system can be brought about by doing some work on it.

ii) The other way to increase the internal energy of the gas is to quickly push the piston inside the cylinder, so that the gas is compressed, as

shown in Fig. 4.5.(b). In this case, we know that the piston does some work on the gas in moving it through some distance. The gas gains energy and its temperature is increased. On the other hand, if the gas pushes the piston out, so that the gas is expanded, some work is done by the gas. It loses some of its energy and the gas cools down.



Use your brain power

Why is there a change in the energy of a gas when its volume changes?

Thus, we see that the internal energy of a system can be changed in two different ways, 1) by heating it or 2) by doing work on it. The experiment we discussed just now can be carried out in a very meticulous way so that we achieve the same change in temperature of the gas by both the methods.

Conclusion of this experiment leads us to a very important principle of thermodynamics. It is related to the work done on the system (or, by the system) and the change in the internal energy of the system. Both are related through the energy that is transferred to (or, by) the system and the heat that is involved in the process. This leads us to the First Law of Thermodynamics.



Can you recall?

During the middle of nineteenth century, James Joule showed that mechanical work done and the heat produced while doing that work are equivalent. This equivalence is the mechanical equivalent of heat. The relation between the mechanical work W and the corresponding heat produced H is $W = J \times H$. The constant J is the mechanical equivalent of heat.

4.5 First Law of Thermodynamics: (Work and Heat are related)

The first law of thermodynamics gives the mathematical relation between heat and work.

4.5.1 First Law of Thermodynamics

Consider a very common thermodynamic system which consists of some quantity of an ideal gas enclosed in a cylinder with a movable, massless, and frictionless piston. Figure 4.6 shows such arrangement. In this, the gas inside the cylinder is the system and the cylinder along with the piston is its environment.

At this stage, we will tentatively base our discussion on the basis of the kinetic theory, that is, the microscopic description of a system. It is important to keep in mind that a thermodynamic system can be completely described on the basis of the macroscopic model. (We will discuss it briefly at a later stage).

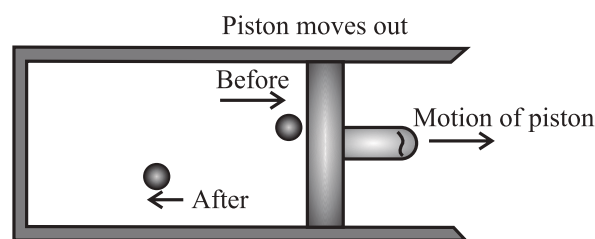

Fig. 4.6 (a): Positive work done by a system.

First, consider the work done by the system (the gas) in increasing the volume of the cylinder. During expansion, (Fig.4.6 (a)) the gas molecules which strike the piston lose their momentum to it, and exert a pressure on it. As a result, the piston moves through a finite distance. *The gas does a positive work on the piston.* When the piston is pushed in so that the volume of the gas decreases, (Fig.4.6 (b)) the gas molecules striking it gain momentum from the piston. *The gas does a negative work on the piston.*

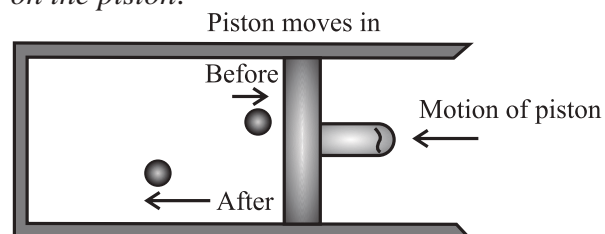
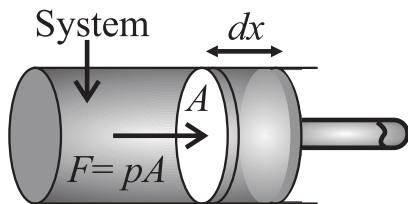

Fig. 4.6 (b): Negative work done by a system.

Consider Fig. 4.7 which shows a system enclosed in a cylinder with a movable, massless, and frictionless piston so that its

volume can change. Let the cross sectional area of the cylinder (and the piston) be A , and the constant pressure exerted by the system on the piston be p . The total force exerted by



Force that system exerts on piston

Fig.4.7: A system enclosed in a cylinder.

the system on the piston will be $F = pA$. If the piston moves through an infinitesimal (very small) distance dx , the work done by this force is,

$$dW = pdV$$

But $A dx = dV$, the infinitesimal change in the volume of the cylinder. Hence, the work done by the system in bringing out this infinitesimal change in the volume can be written as,

$$dW = pdV \quad \text{--- (4.1)}$$

If the initial volume of the cylinder is V_i and its volume after some finite change is V_f , then the total work done in changing the volume of the cylinder is,

$$W = \int_{V_i}^{V_f} pdV = p(V_f - V_i) \quad \text{--- (4.2)}$$

The change in volume in this case is small.

Example 4.2 : A gas enclosed in a cylinder is expanded to double its initial volume at a constant pressure of one atmosphere. How much work is done in this process?.

Solution : Given: Pressure of one atmosphere $p = 1.01 \times 10^5$ Pa, change in volume $(V_f - V_i) = 0.5$.

$$W = p(V_f - V_i) = 1.01 \times 10^5 (+0.5) \\ = 0.505 \times 10^5 = 5.05 \times 10^4 \text{ J}$$

Is this work done on the gas or by the gas?
How do you know this?

Now we know that the internal energy of a system can be changed either by providing some heat to it (or, by removing heat from it) or, by doing some work on it (or extracting

work from it). Equation (4.2) gives the amount of work done in changing the volume of a system.

When the amount of heat Q is added to the system and the system does not do any work during the process, its internal energy increases by the amount, $\Delta U = Q$. On the other hand, when the system does some work to increase its volume, and no heat is added to it while expanding, the system loses energy to its surrounding and its internal energy decreases. This means that when W is positive, ΔU is negative and, vice versa. Therefore, we can write, $\Delta U = -W$.

In practice, the internal energy can change by both the ways. Therefore, we consider the effect of both together and write the total change in the internal energy as,

$$\Delta U = Q - W \quad \text{--- (4.3)}$$

This is the mathematical statement of the first law of thermodynamics. This equation tells that the change in the internal energy of a system is the difference between the heat supplied to the system and the work done by the system on its surroundings.

We can rearrange the Eq. (4.3) and write,

$$Q = \Delta U + W \quad \text{--- (4.4)}$$

This is also the first law of thermodynamics. Both forms of the law are used while studying a system. Equation (4.4) means that when the amount of heat Q is added to a system, its internal energy is increased by an amount ΔU and the remaining is lost in the form of work done W on the surrounding.



Can you tell?

Can you explain the thermodynamics involved in cooking food using a pressure cooker?

Example 4.3 : 1.0 kg of liquid water is boiled at 100 °C and all of it is converted to steam. If the change of state takes place at the atmospheric pressure (1.01×10^5 Pa), calculate (a) the energy transferred to the

system, (b) the work done by the system during this change, and (c) the change in the internal energy of the system. Given, the volume of water changes from $1.0 \times 10^{-3} \text{ m}^3$ in liquid form to 1.671 m^3 when in the form of steam.

Solution : (a) Liquid water changes to steam by absorbing the heat of vaporization. In case of water, this is

$$Q = L \cdot m$$

$$\therefore Q = \left(2256 \frac{\text{kJ}}{\text{kg}} \right) \cdot (1.0 \text{ kg}) = 2256 \text{ kJ}$$

(b) The work done can be calculated by using Eq. (4.1). Here, the pressure is $1.01 \times 10^5 \text{ Pa}$ and the change in volume is $dV = (1.671 \text{ m}^3 - 1.0 \times 10^{-3} \text{ m}^3)$

The work done is,

$$W = pdV = (1.01 \times 10^5 \text{ Pa}) \times (1.671 \text{ m}^3 - 1.0 \times 10^{-3} \text{ m}^3)$$

$$= 1.69 \times 10^5 \text{ J} = 169 \text{ kJ}$$

(c) Change in the internal energy of the system can be calculated by using Eq. (4.3).

$$\Delta U = Q - W$$

$$= 2265 \text{ kJ} - 169 \text{ kJ} = 2096 \text{ kJ}$$

This energy is positive which means that there is an increase in the internal energy of water when it boils. This energy is used to separate water molecules from each other which are closer in liquid water than in water in vapour form.

Can you explain how the work done by the system is utilized?

The quantities W and Q can be positive, negative or zero, therefore, ΔU can be positive, negative, or zero. Figure 4.8 shows these three cases. Figure 4.8. (a) shows the case when

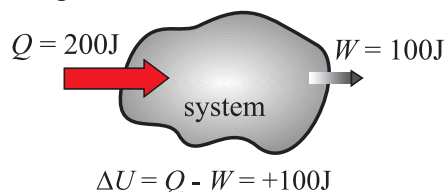

Fig. 4.8 (a) : Increase in internal energy ($\Delta U > 0$).

more heat is added to the system than the work done by it. The internal energy of the system increases, ($\Delta U > 0$). Figure 4.8. (b)

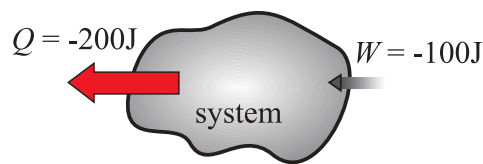

Fig. 4.8 (b): Decrease in internal energy ($\Delta U < 0$)

shows the case when more work is done by the system than the heat added to it. In this case, the internal energy of the system decreases, ($\Delta U < 0$). Figure 4.8.(c) shows the case when heat added to the system and the work done by it are the same. The internal energy of the system remains unchanged, ($\Delta U = 0$).

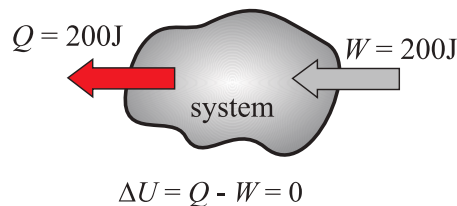

Fig. 4.8 (c): No change in internal energy ($\Delta U = 0$)

The law of conservation of energy we studied in XIth Std. was applicable to an isolated system, i.e., to a system in which there is no exchange of energy. The first law of thermodynamics, Eq. (4.3) and Eq. (4.4) is an extension of the law of conservation of energy to systems which are not isolated, i.e., systems that can exchange energy. This exchange can be in the form of work W , or heat Q . The first law of thermodynamics is thus a generalization of the law of conservation of energy.

We started this discussion on the basis of the microscopic view (kinetic theory) of internal energy. In practice, this is not useful because it does not help us in calculating the internal energy of a system. In physics, we need some measurable quantities so that the internal energy of a system can be measured, though indirectly. Equation (4.3), $\Delta U = Q - W$, provides this method. The internal energy

appears as the difference between the heat Q supplied to (or released by) the system and the work W done by (or done on) the system. Both are measurable quantities. In physics, we generally discuss volume expansion of a gas when heat is added to it. In this case, the heat added and the resulting expansion of the gas can be measured. The expansion of a gas to do work in moving a piston in an internal combustion engine can also be measured.

Example 4.4: 104 kJ of work is done on certain volume of a gas. If the gas releases 125 kJ of heat, calculate the change in internal energy (in kJ) of the gas.

Solution: We know from the first law of thermodynamics that $\Delta U = Q - W$
Given, $W = 104$ kJ. This work is done on the gas, hence we write $W = -104$ kJ.
Similarly, the heat is released by the gas and we write $Q = -125$ kJ.

Therefore, from the first law of thermodynamics, we have,

$$\Delta U = |Q| - |W|$$

$$\therefore \Delta U = (125 - 104) = 21 \text{ kJ}$$



Remember this

The first law of thermodynamics gives the relationship between the heat transfer, the work done, and the change in the internal energy of a system.

4.6 Thermodynamic state variables

Earlier, we have discussed thermal equilibrium and understood the concept of temperature and the Zeroth law of thermodynamics. Thermodynamics is not the study of changes in temperature of a system only. As we have seen earlier, when temperature of a system changes (it gains or releases energy), its other properties can also change. Let us understand these properties. We will define the term property of a thermodynamic system first.

Property of a system or a system variable:

It is any measurable or observable characteristic or property of a system when the system remains in equilibrium. A property is also called a state variable of the system. We will use the term variable to describe characteristic of a system. For example, pressure, volume, temperature, density and mass of a system are some of the variables that are used to describe a system. These are measurable properties and are called macroscopic variables of a system.

Intensive and Extensive variables:

Intensive variables do not depend on the size of the system. Extensive variables depend on the size of the system. Consider a system in equilibrium. Let this system be divided into two equal compartments, each with half the original volume. We notice that the pressure p , the temperature T , and the density ρ are the same in both compartments. These are intensive variables. The total mass M , and the internal energy U of the system are equally divided in the two compartments and are extensive variables of the system.

4.6.1 Thermodynamic Equilibrium:

A system is in thermodynamic equilibrium if the following three conditions of equilibrium are satisfied simultaneously. These are, 1) Mechanical equilibrium, 2) Chemical equilibrium, and 3) Thermal equilibrium.

1) Mechanical equilibrium: When there are no unbalanced forces within the system and between the system and its surrounding, the system is said to be in mechanical equilibrium. The system is also said to be in mechanical equilibrium when the pressure throughout the system and between the system and its surrounding is the same. Whenever some unbalanced forces exist within the system, they will get neutralized with time to attain the condition of equilibrium. A system is in mechanical equilibrium when the pressure in it is the same throughout and does not change with time.

2) Chemical equilibrium: A system is said to be in chemical equilibrium when there are no chemical reactions going on within the system, or there is no transfer of matter from one part of the system to the other due to diffusion. A system is in chemical equilibrium when its chemical composition is the same throughout and does not change with time.

3) Thermal equilibrium: When the temperature of a system is uniform throughout and does not change with time, the system is said to be in thermal equilibrium. We have discussed thermal equilibrium at length earlier.



Activity

Identify different thermodynamic systems and study their equilibrium. Classify them in to one of the categories we just discussed.

4.6.2 Thermodynamic State Variables and Equation of State

Every equilibrium state of a thermodynamic system is completely described by specific values of some macroscopic variables, also called state variables. For example, an equilibrium state of a gas is completely described by the values of its pressure p , volume V , temperature T , and mass m . Consider a mixture of gases or vapours as in case of the fuel in an automobile engine. Its state can be described by the state variables but we also need its composition to describe its state.



Fig. 4.9: Non equilibrium state.

A thermodynamic system is not always in equilibrium. Figure 4.9 shows such case. For example, when an inflated ball is punctured, the air inside it suddenly expands to the atmosphere. This is not an equilibrium state. During the rapid expansion, pressure of the

air may not be uniform throughout. Similarly, the fuel (a mixture of petrol vapour) in the cylinder of an automobile engine undergoing an explosive chemical reaction when ignited by a spark is not an equilibrium state. This is because its temperature and pressure are not uniform. *Such system which is not in equilibrium cannot be described in terms of the state variables.* Eventually, the air in first case, and the fuel in the second case reach a uniform temperature and pressure and attain thermal and mechanical equilibrium with its surroundings. Thus it attains thermodynamic equilibrium.

In simple words, thermodynamic state variables describe the equilibrium states of a system. The various state variables are not always independent. They can be mathematically related. *The mathematical relation between the state variables is called the equation of state.* For example, for an ideal gas, the equation of state is the ideal gas equation,

$$pV = nRT \quad \text{--- (4.5)}$$

Where, p , V and T are the pressure, the volume and the temperature of the gas, n is the number of moles of the gas and R is the gas constant. For a fixed amount of the gas, i.e., for given n , there are thus, only two independent variables. It could be p and V , or p and T , or V and T .

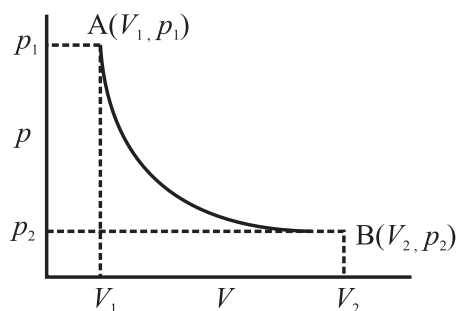

Fig. 4.10: A typical p - V diagram.

The graphical representation of equation of state of a system (of a gas) is called the p - V diagram, or the p - V curve (the pressure - volume curve), or the indicator diagram of the system. Figure 4.10 shows a typical p - V diagram for an ideal gas at some constant

temperature. The pressure-volume curve for a constant temperature is called an isotherm. Real gases may have more complicated equations of state and therefore, a complicated p - V diagram. (The Van-der-Wall's equation with various corrections for example, is complicated for a real gas and is equally interesting). The equation of state of a system (usually a gas confined to a cylinder with a movable, frictionless and massless piston) and its p - V diagram are very useful in studying its behavior. In the following sections, we will discuss some systems and their behavior using p - V diagrams.

4.6.3 The p - V diagram:

Consider Eq. (4.2), i.e.,

$$W = \int_{V_i}^{V_f} dW = \int_{V_i}^{V_f} p dV$$

The integral in this equation can be evaluated if we know the relation between the pressure p and the volume V , or the path between the limits of integration. Equation. (4.2) can be represented graphically.

A gas confined to a cylinder with a movable, frictionless, and massless piston can be, 1) expanded with varying pressure (Figure 4.11 a), or 2) it can be compressed with varying pressure Fig. 4.11 (b), or 3) it can expand at constant pressure Fig. 4.11 (c).

The area under the curve in the p - V diagram, is the graphical representation of the value of the integral in Eq. (4.2). *Since this integral represents the work done in changing the volume of the gas, the area under the p - V curve also represents the work done in this process.*



Use your brain power

Verify that the area under the p - V curve has dimensions of work

Figure 4.11 (a) shows expansion of the gas. Its volume changes due to outward displacement of the piston and the pressure of the gas

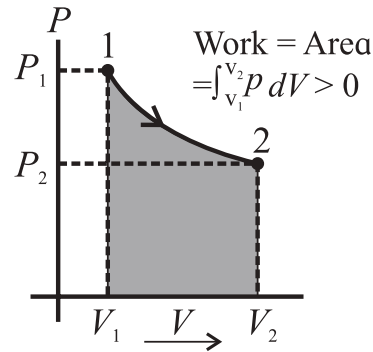

Fig. 4.11 (a): Positive work with varying pressure.

decreases. The work done by the gas in this case is positive because the volume of the gas has increased.

Similarly, Fig. 4.11 (b) shows compression due to inward displacement of the piston. The pressure of the gas is increased and the work done by the gas is now negative.

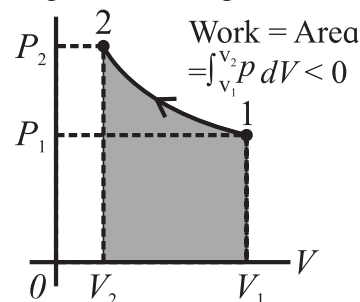

Fig. 4.11 (b): Negative work with varying pressure.

Figure 4.11 (c) shows the p - V diagram when the volume of the gas changes from V_i to V_f at a constant pressure. The curve is actually a line parallel to the volume axis. The work done during volume change at constant pressure is $W = p(V_f - V_i)$, (Only in this case the integration is $p(dV)$).

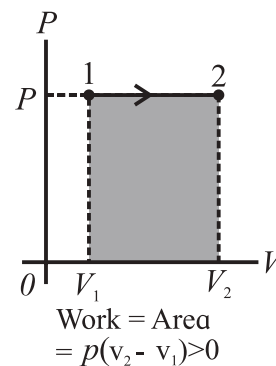

Fig. 4.11 (c): Positive work at constant pressure.

When the volume is constant in any thermodynamic process, the work done is zero because there is no displacement. These

changes are very slow. We will discuss such processes in some details in a later section.

4.7 Thermodynamic Process:

A thermodynamic process is a procedure by which the initial state of a system changes to its final state. During such a change, there may be a transfer of heat into the system from its environment, (positive heat), for example when water boils heat is transferred to water. Heat may be released from the system to its environment (negative heat). Similarly, some work can be done by the system (positive work), or some work can be done on the system (negative work). When the piston in a cylinder is pushed in, some work is done on the system. We know that these changes should occur infinitesimally slowly so that the system is always in thermodynamic equilibrium. Such processes in which changes in the state variables of a system occur infinitesimally slowly are called *quasi static systems*.

When a thermodynamic system changes from its initial state to its final state, it passes through a series of intermediate states. This series of intermediate states when plotted on a $p - V$ diagram is called a path. The $p - V$ curve or the $p - V$ diagram, shown in Fig. 4.11 is such a path. It tells us the way a system has gone through a change.

4.7.1 Work Done During a Thermodynamic Process:

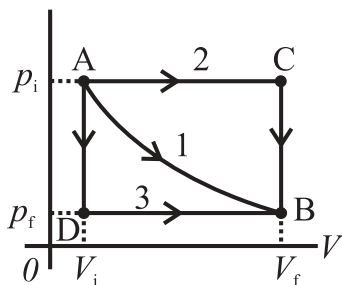

Fig. 4.12 (a): Different ways to change a system.

Let us understand the relation between a path and the work done along a path. Consider Fig. 4.12 (a) which describes different ways in which we can change the state of a system. The system is initially at state A on the $p - V$ diagram. Its pressure is p_i and volume is V_i . We say that the state is indicated by the coordinates

(V_i, p_i) . The final state of the system is shown by the point B with its coordinates given by (V_f, p_f) . The curve 1 (path 1) shown in the Fig. 4.12 (a) is one of the many ways (paths) in which we can change the system from state A to the state B. When the system changes itself from A to B along the path 1, both its pressure and volume change. The pressure decreases while the volume increases. The work done by the system is positive (because the volume increases). It is given by the area under the curve 1 as shown in the Fig. 4.12 (b).

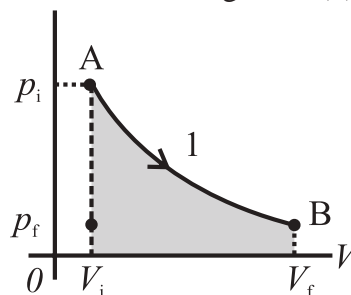

Fig. 4.12 (b): Pressure and volume both change.

Second way to change the state from A to state B is path 2 as shown in Fig. 4.12 (c). In this case, the volume increases to V_f from the point A up to the point C at the constant pressure p_i . The pressure then decrease to p_f as shown. The volume remains constant during this change. The system is now in the state B with its coordinates given by (V_f, p_f) .

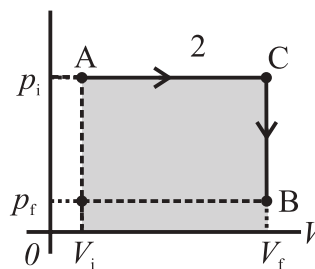

Fig. 4.12 (c): First the volume changes at constant pressure and then pressure changes at constant volume.

The work done in this process is represented by the shaded area under the curve 2 as in Fig. 4.12 (c).

Third way to change the state from A to state B is path 3 as shown in Fig. 4.12 (d). In this case, the pressure decreases from p_i to p_f but the volume remains the same. Next, the volume changes to V_f at constant pressure p_f . The work done in this process is represented

by the shaded area under the curve 3 as in Fig. 4.12 (d). It is easily noticed that in the three cases we discussed, the amount of work done is not the same.

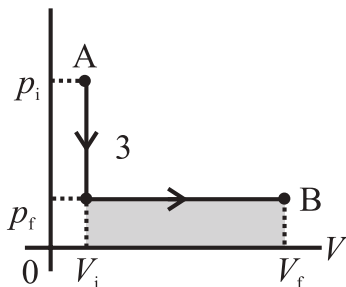

Fig. 4.12 (d): First the pressure drops at constant volume and then volume increases at constant pressure.

Remember that these are only three paths amongst many along which the system can change its state. It is interesting to note that in all these cases, though work done during the change of state is different, the initial and the final state of the system is the same.

We conclude that *the work done by a system depends not only on the initial and the final states, but also on the intermediate states, i.e., on the paths along which the change takes place.*

4.7.2 Heat Added During a Thermodynamic Process:

Thermodynamic state of a system can be changed by adding heat also. Consider a thermodynamic system consisting of an ideal gas confined to a cylinder with a movable, frictionless, and massless piston. Suppose we want to change the initial volume V_i of the gas to the final volume V_f at a constant temperature.

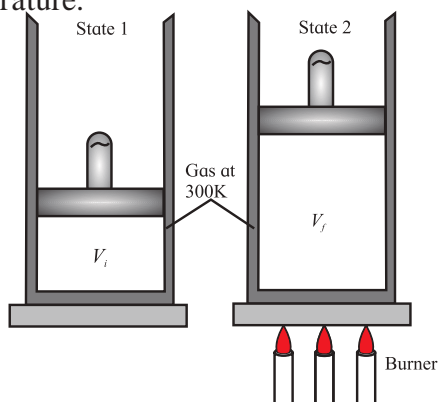

Fig. 4.13 (a): Isothermal expansion of gas, Burner supplies heat, system does work on piston ($W>0, Q>0$).

There are two different ways in which this change in volume can be made. Figure 4.13 (a) shows the first method. In this case, the gas is heated slowly, in a controlled manner so that it expands at a constant temperature. It reaches the final volume V_f isothermally. The system absorbs a finite amount of heat during this process.

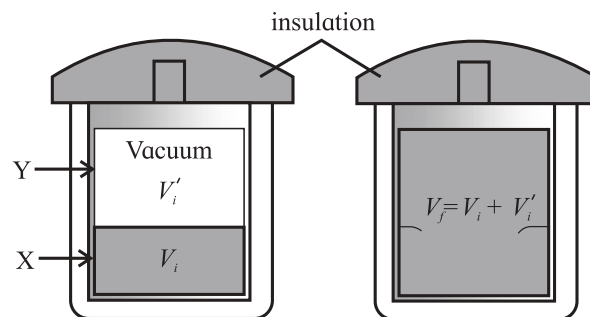

Fig. 4.13 (b): Sudden uncontrolled expansion of gas. No heat enters, system does no work ($W=0, Q=0$).

In the second case, shown in Fig. 4.13 (b) gas cylinder is now surrounded by an insulating material and it is divided into two compartments by a thin, breakable partition. The compartment X has a volume V_i and the compartment Y has a volume V'_i so that $V_i + V'_i = V_f$. The compartment X of the cylinder is filled with the same amount of gas at the same temperature as that in the first case shown in the Fig. 4.13 (a). The compartment Y is empty, it contains no gas particles or any other form of matter. The initial state of the system is the same in both cases.

The partition is now suddenly broken. This causes a sudden, uncontrolled expansion of the volume of the gas. The gas occupies the volume that was empty before the partition is broken. There is no exchange of heat between the gas and its environment because the cylinder is now surrounded by an insulating material. The final volume of the system after the partition is broken is V_f . In this case, the gas has not done any work during its expansion because it has not pushed any piston or any other surface for its expansion. Such expansion is called

free expansion. A common example of free expansion is abrupt puncturing of an inflated balloon or a tyre.

It is experimentally observed that when an ideal gas undergoes a free expansion, there is no change of temperature. Therefore, the final state of the gas in this case also, is the same as the first case. The intermediate states or the paths during the change of state in the first and the second case are different. But the initial and the final states are the same in both cases. Figures 4.13 (a) and (b) represent two different ways of taking a system from the initial state to the final state. This means we have two different paths connecting the same initial and the final states of a system.

In case of the method shown in Fig. 4.13 (a) there is an exchange of heat. In case of the method shown in Fig. 4.13 (b), there is no exchange of heat and also, the system does not do any work at all because there is no displacement of any piston or any other surface.

To conclude, heat transferred to a system also depends on the path.

4.7.3 Classification of Thermodynamic Processes:

As we have seen earlier, a thermodynamic state can be described by its pressure p , volume V , and temperature T . These are the state variables of a system. At present, we will restrict our description of a thermodynamic system only to its pressure, volume and temperature.

A process by which two or more of these variables can be changed is called a thermodynamic process or a thermodynamic change. As we have discussed earlier, there can be a number of different ways to change these parameters, that is, there are different thermodynamic processes. But in practice, for the sake of measurement, any one of the state variables is held constant and other two are varied. This leads us to a very useful way of classifying thermodynamic processes.

1. Reversible and Irreversible Processes:

We know that when two objects at different temperatures are brought in thermal contact they reach a thermal equilibrium. In this process, the object at higher temperature loses its heat and the object at lower temperature gains heat. (But we never observe that after some time, the two objects are back to their initial temperatures). The object that was previously hot never becomes hot again and the previously cold object never becomes cold again once they reach thermal equilibrium. That means the two objects at different temperatures reaching thermal equilibrium is an irreversible process. Such processes do not restore the initial state of the system. Puncturing an inflated balloon or a tyre, rubbing our palms together, burning a candle are some familiar examples of irreversible thermodynamic processes.

Some processes such as melting of ice, freezing of water, boiling of water, condensation of steam can be reversed. That means the initial states of the system can be restored. These are some familiar thermodynamic processes that are reversible.

A thermodynamic process (change) can be a reversible process (change) or it can be an irreversible process (change).

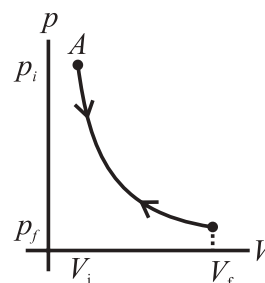

Fig. 4.14 (a): p-V diagram of Reversible process.

Earlier, we have seen that a thermodynamic process can be represented by a $p - V$ diagram. A reversible process is a change that can be retraced in reverse (opposite) direction. The path of a reversible thermodynamic process is the same in the forward and the reverse direction. Figure 4.14 (a) shows the path of

a reversible thermodynamic process. This path shows a reversible expansion of a gas followed by its reversible compression. Such changes are very slow and there is no loss of any energy in the process and the system is back to its initial state after it is taken along the reverse path. Reversible processes are ideal processes. *A real thermodynamic process will always encounter some loss due to friction or some other dissipative forces.*

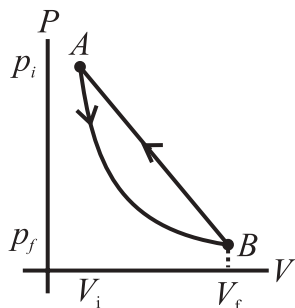

Fig. 4.13 (b): p-V diagram of Irreversible process.

An irreversible process is a change that cannot be retraced in reverse (opposite) direction. The path of an irreversible thermodynamic process is not the same in the forward and the reverse direction. Figure 4.14 (b) shows the path of an irreversible thermodynamic process. There is a permanent loss of energy from the system due to friction or other dissipative forces in an irreversible process. The change of state depends on the path taken to change the state during an irreversible process. An irreversible process shows a hysteresis. Most real life thermodynamic processes that we deal with are irreversible.



Try this

Rub your palms in one direction only (say away from your wrist) till you feel warmth. Rub them in the opposite way. Do you feel warm again or you feel cold? Discuss your experience.

Cause of Irreversibility:

There are two main reasons of the irreversibility of a thermodynamic process.

1. Many processes such as a free expansion or an explosive chemical reaction take the system to non-equilibrium states.
2. Most processes involve friction, viscosity or some other dissipative forces. For example, an object sliding on a surface stops after moving through some distance due to friction and loses its mechanical energy in the form of heat to the surface and it gets heated itself. The dissipative forces are always present everywhere and can be minimized at best, but cannot be fully eliminated.



Remember this

All spontaneous natural processes are irreversible. For example, heat always flows from a higher temperature to a lower temperature on its own. We can say that an irreversible process gives us the preferred direction of a thermodynamic process. *An irreversible process can be said to be unidirectional process.*

Assumptions for discussion of thermodynamic processes:

We will be discussing various types of thermodynamic systems in the following sections. Here are the assumptions we make for this discussion.

- i) Majority of the thermodynamic processes we will be discussing in the following sections are reversible. That is, they are quasistatic in nature. They are extremely slow and the system undergoes infinitesimal change at every stage except the adiabatic processes. The system is, therefore, in thermodynamic equilibrium during all the change.
- ii) The 'system' involved in all the processes is an ideal gas enclosed in a cylinder having a movable, frictionless, and massless piston. Depending on the requirements of the process, the walls of the cylinder

can be good thermal conductors (for an isothermal process) or can be thermally insulating (for an adiabatic process).

iii) The ideal gas equation is applicable to the system.

2. Isothermal process:

A process in which change in pressure and volume takes place at a constant temperature is called an isothermal process or isothermal change. For such a system $\Delta T = 0$. *Isothermal process is a constant temperature process.* This is possible when a system is in good thermal contact with its environment, and the transfer of heat from, or to the system, is extremely slow so that thermal equilibrium is maintained throughout the change.

For example, melting of ice, which takes place at constant temperature, is an isothermal process.



Remember this

1. For an isothermal process, none of the quantities Q and W is zero.
2. For an isothermal change, total amount of heat of the system does not remain constant.

Thermodynamics of Isothermal Process:

The temperature of a system remains constant in an isothermal change and Boyle's law can be applied to study these changes. Therefore, the equation of state for an isothermal change is given by,

$$pV = \text{constant} \quad \text{--- (4.6)}$$

If p_i, V_i and p_f, V_f are the variables of a system in its initial and the final states respectively, then for an isothermal change,

$$p_i V_i = p_f V_f = \text{constant.}$$

Consider the isothermal expansion of an ideal gas. Let its initial volume be V_i and the final volume be V_f . The work done in an infinitesimally small isothermal expansion is given by Eq. (4.1), $dW = pdV$. The total work

done in bringing out the expansion from the initial volume V_i to the final volume V_f is given by,

$$W = \int_{V_i}^{V_f} pdV$$

But we know that for an ideal gas, $pV = nRT$. Using this in the previous equation we get,

$$W = nRT \int_{V_i}^{V_f} \frac{dV}{V}$$

$$\therefore W = nRT \ln \frac{V_f}{V_i} \quad \text{--- (4.7)}$$

For an ideal gas, its internal energy depends on its temperature. Therefore, during an isothermal process, the internal energy of an ideal gas remains constant ($\Delta U = 0$) because its temperature is constant ($\Delta T = 0$).

The first law of thermodynamics (Eq. 4.4) when applied to an isothermal process would now read as,

$$Q = W \quad \text{--- (4.8)}$$

$$\therefore Q = W = nRT \ln \frac{V_f}{V_i} \quad \text{--- (4.9)}$$

Thus, the heat transferred to the gas is completely converted into the work done, i.e., for expansion of the gas. From Eq. (4.8) it is obvious that when the gas absorbs heat, it does positive work and its volume expands. When the gas is compressed, it releases heat and it does negative work.

Any change of phase occurs at a constant temperature, and therefore, it is an isothermal process. Figure 4.15 shows the $p - V$ diagram of an isothermal process. It is called as an *isotherm*.

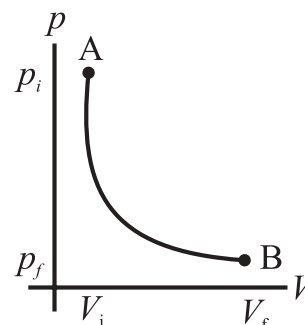

Fig. 4.15: p - V diagram of an isothermal process.

Example 4.5:

0.5 mole of gas at temp 300 K expands isothermally from an initial volume of 2.0L to final volume of 6.0L. (a) What is the work done by the gas? ($R = 8.31 \text{ J mol}^{-1} \text{ K}^{-1}$), (b) How much heat is supplied to the gas?

Solution: (a) The work done in isothermal expansion is $W = nRT \ln \left(\frac{V_f}{V_i} \right)$

Where $n = 0.5$, $V_f = 6\text{L}$, $V_i = 2\text{L}$

$$W = 0.5 \text{ mol} \times \frac{8.319}{\text{mol} \cdot \text{K}} \times 300\text{K} \cdot \ln \left(\frac{6\text{L}}{2\text{L}} \right) \\ = 1.369 \text{ kJ.}$$

(b) From the first law of thermodynamics, the heat supplied in an isothermal process is spent to do work on a system. Therefore, $Q = W = 1.369 \text{ kJ}$.

Can you explain the significance of positive sign of the work done and the heat?

**Remember this**

Always remember for an isothermal process:

1. Equation of state: $pV = \text{constant}$
2. $\Delta T = 0$. Constant temperature process, perfect thermal equilibrium with environment.
3. $\Delta U = 0$. No change in internal energy, energy is exchanged with the environment.
4. $Q = W$. Energy exchanged is used to do work.
5. $W = p \Delta V$
6. An isothermal change is a very slow change. The system exchanges heat with its environment and is in thermal equilibrium with it throughout the change.

**Use your brain power**

Show that the isothermal work may also be expressed as $W = nRT \ln \left(\frac{P_i}{P_f} \right)$.

3. Isobaric process:

It is a constant pressure process. Boiling water at constant pressure, normally at atmospheric pressure, is an isobaric process. Figure (4.16) shows the p - V diagram of an isobaric process. It is called as an *isobar*. The different curves shown on the maps provided by the meteorology department are isobars. They indicate the locations having same pressure in a region. For an isobaric process, none of the quantities ΔU , Q and W is zero.

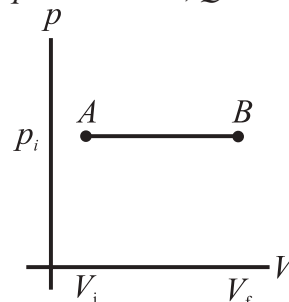

Fig. 4.16 : p - V diagram of an isobaric process.

Thermodynamics of Isobaric process:

The pressure of a system remains constant in this process i.e. $\Delta p = 0$. Consider an ideal gas undergoing volume expansion at constant pressure. If V_i and T_i are its volume and temperature in the initial state of a system and V_f and T_f are its final volume and temperature respectively, the work done in the expansion is given by

$$W = p dV = p(V_f - V_i) = nR(T_f - T_i) \quad \text{--- (4.10)}$$

Also, the change in the internal energy of a system is given by,

$$\Delta U = nC_V \Delta T = nC_V (T_f - T_i) \quad \text{--- (4.11)}$$

Where, C_V is the specific heat at constant volume and $\Delta T = (T_f - T_i)$ is the change in its temperature during the isobaric process.

According to the first law of thermodynamics, the heat exchanged is given by, $Q = \Delta U + W$

Using the previous two equations we get,

$$Q = nC_V (T_f - T_i) + nR(T_f - T_i)$$

$$Q = (nC_V + nR)(T_f - T_i)$$

$$Q = nC_p (T_f - T_i) \quad \text{--- (4.12)}$$

Where, C_p is the specific heat at constant pressure $\therefore C_p = C_V + R$.

Equation (4.12) tells that *the temperature of a system changes in an isobaric process therefore, its internal energy also changes* (Eq. 4.11). The heat exchanged (Eq. 4.12) is partly used for increasing the temperature and partly to do some work. The change in the temperature of the system depends on the specific heat at constant pressure C_p .

Example 4.6:

One mole of an ideal gas is initially kept in a cylinder with a movable frictionless and massless piston at pressure of 1.0 mPa, and temperature 27°C. It is then expanded till its volume is doubled. How much work is done if the expansion is isobaric?

Solution: Work done in isobaric process given by $W = p\Delta V = (V_f - V_i)$.

$$V_f = 2V_i \therefore W = 2pV_i$$

V_i can be found by using the ideal gas equation for initial state.

$$p_i V_i = nRT_i \text{ for } n = 1 \text{ mol,}$$

$$V_i = \frac{RT_i}{p_i} = 8.31 \times \frac{300}{1 \times 10^6} = 24.9 \times 10^{-4} \text{ m}^3$$

$$\therefore W = 2 \times 10^6 \times 24.9 \times 10^{-4}$$

$$W = 4.9 \text{ kJ}$$

**Remember this**

Always remember for an isobaric process:

1. $\Delta p = 0$. Constant pressure process.
2. Temperature of the system changes, $\Delta T \neq 0$.
3. $Q = \Delta U + W$. Energy exchanged is used to do work and also to change internal energy, i.e., to increase its temperature.
4. $W = p\Delta V$. Volume changes when work is done.

4. Isochoric process:

It is a constant volume process. A system does no work on its environment during an isochoric change. Figure 4.17 shows the

p - V diagram of an isochoric process. For an isochoric process, $\Delta V = 0$, and we have, from the first law of thermodynamics, $\Delta U = Q$. This means that for an isochoric change, all the energy added in the form of heat remains in the system itself and causes an increase in its internal energy. Heating a gas in a constant volume container or diffusion of a gas in a closed chamber are some examples of isochoric process.

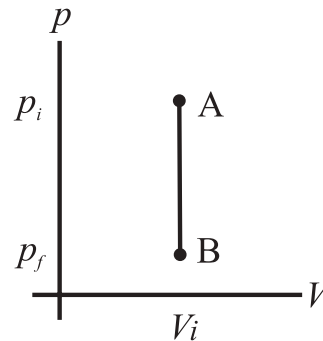

Fig. 4.17: p-V diagram of isochoric process.

Thermodynamics of Isochoric process:

For an isochoric process, we have, $\Delta V = 0$. The system does not do any work and all the energy supplied to the system is converted into its internal energy. The first law of thermodynamics for isochoric process is

$$Q = \Delta U \quad \text{--- (4.13)}$$

The change in internal energy is given by

$$\Delta U = nC_v \Delta T$$

The work done is given by

$$W = p\Delta V = 0 \text{ (because } \Delta V = 0 \text{)}.$$

The heat exchanged is given by the first law of thermodynamics,

$$Q = \Delta U + W = \Delta U = nC_v \Delta T \quad \text{--- (4.14)}$$

**Remember this**

Always remember for an isochoric process:

1. $\Delta V = 0$. Constant volume process.
2. $W = 0$. No work is done because volume remains constant, $\Delta V = 0$.
3. $Q = \Delta U$. Energy exchanged is used to change internal energy.
4. $\Delta T \neq 0$. Temperature of the system changes.

5. Adiabatic process:

It is a process during which there is no transfer of heat from or to the system. Figure 4.18 shows the p - V diagram of an adiabatic process. For an adiabatic change, $Q = 0$. Heat transfer to or from the system is prevented by either perfectly insulating the system from its environment, or by carrying out the change rapidly so that there is no time for any exchange of heat. Puncturing an inflated balloon or a tyre are some familiar examples of adiabatic changes. For an adiabatic change,

$$\Delta U = -W \quad \text{--- (4.15)}$$

When a system expands adiabatically, W is positive (work is done by the system) and ΔU is negative, the internal energy of the system decreases. When a system is compressed adiabatically, W is negative (work is done on the system), and ΔU is positive. *The internal energy of the system increases in an adiabatic process.* It is observed that for many systems, temperature increases when internal energy increases and decreases when the internal energy is decreased.

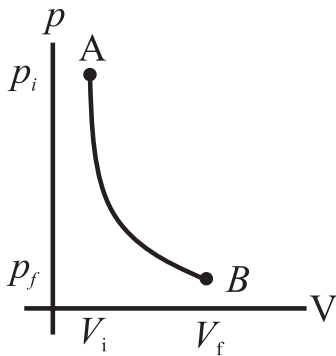

Fig. 4.18: p-V diagram of adiabatic process.

Thermodynamics of Adiabatic process:

For an adiabatic process we have,

$$pV^\gamma = \text{constant} = C \quad \text{--- (4.16)}$$

where, γ is the ratio of the specific heat at constant pressure to the specific heat at constant volume, i.e., $\gamma = \frac{C_p}{C_v}$

γ is also called *adiabatic ratio*. For moderate temperature changes, the value of γ is $\frac{5}{3}$ for monoatomic gases, $\frac{7}{5}$ for diatomic

gases and $\frac{8}{6} = \frac{4}{3}$ for polyatomic gases. Equations (3.23), (3.24) and (3.25) can be extended to obtain these values.

An adiabatic system is thermally isolated from its environment, therefore, it cannot exchange heat with it. Therefore, when a system undergoes an adiabatic change, its temperature and internal energy both change. The change in internal energy is,

$$\Delta U = C_v (\Delta T) \quad \text{--- (4.17)}$$

The work done is,

$$W = \int_{V_i}^{V_f} p dV$$

Using Eq. (4.16) we have,

$$W = C \int_{V_i}^{V_f} \frac{dV}{V^\gamma}$$

$$W = C \times \left[\frac{V^{(-\gamma+1)}}{1-\gamma} \right]_{V_i}^{V_f},$$

where V changes from V_i to V_f .

$$W = \frac{C}{(1-\gamma)} \times \left[\frac{1}{V_f^{(\gamma-1)}} - \frac{1}{V_i^{(\gamma-1)}} \right] \quad \text{--- (4.18)}$$

From (Eq. 4.16) we have,

$$pV^\gamma = C$$

or,

$$p_i V_i^\gamma = p_f V_f^\gamma$$

Therefore, we can write (Eq. 4.18) as,

$$W = \frac{1}{(1-\gamma)} \times \left[\frac{p_f V_f^\gamma}{V_f^{(\gamma-1)}} - \frac{p_i V_i^\gamma}{V_i^{(\gamma-1)}} \right]$$

$$W = \frac{1}{(1-\gamma)} \times (p_f V_f - p_i V_i) \quad \text{--- (4.19)}$$

$$W = \frac{nR(T_i - T_f)}{(1-\gamma)} = \frac{(p_f V_f - p_i V_i)}{(1-\gamma)} \quad \text{--- (4.20)}$$

Equation (4.20) implies that when work is done by the gas, i.e., when the gas expands, $W > 0$, and $T_i > T_f$. This means that the gas will cool down. Similarly, if the work is done on the gas, i.e., if the gas is compressed $W < 0$, and $T_i < T_f$. This means that the gas will warm up.

**Remember this****Always remember for an adiabatic process:**

- Equation of state: $pV^\gamma = \text{constant}$.
- $Q = 0$. No exchange of heat with the surroundings. The system is perfectly insulated from its environment, or the change is very rapid.
- $\Delta U = -W$. All the work is utilized to change the internal energy of the system.
- $\Delta T \neq 0$. Temperature of the system changes.
- Adiabatic expansion causes cooling and adiabatic compression causes heating up of the system.
- $$W = \frac{nR(T_i - T_f)}{(1-\gamma)} = \frac{(p_f V_f - p_i V_i)}{(1-\gamma)}$$
- Most of the times, an adiabatic change is a sudden change. During a sudden change, the system does not find any time to exchange heat with its environment.

Example 4.7: An ideal gas of volume 1.0L is adiabatically compressed to $(1/15)^{\text{th}}$ of its initial volume. Its initial pressure and temperature is 1.01×10^5 Pa and 27°C respectively. Given C_v for ideal gas = 20.8J/mol.K and $\gamma = 1.4$. Calculate (a) final pressure, (b) work done, and (c) final temperature. (d) How would your answers change, if the process were isothermal?

Solution: (a) To calculate the final pressure p_f . This can be calculated by using

$$\begin{aligned} p_i &= p_f \left(\frac{V_i}{V_f} \right)^\gamma \\ &= (1.01 \times 10^5 \text{ Pa}) (15)^{1.4} \\ &= 44.8 \times 10^5 \text{ Pa (about 45 atm)}. \end{aligned}$$

(b) To calculate the work done,

$$W = \frac{(p_f V_f - p_i V_i)}{(1-\gamma)}$$

$$\begin{aligned} W &= \frac{1}{\gamma-1} (P_i V_i - P_f V_f) P_i = P_f \\ &= \frac{1}{1.4-1} \left[\left[(1.01 \times 10^5)(1.0 \times 10^{-3}) \right] \right. \\ &\quad \left. - \left[(44.8 \times 10^5) \left(\frac{1.0 \times 10^{-3} \text{ m}^3}{15} \right) \right] \right] \\ &= -494 \text{ J} \end{aligned}$$

(c) To calculate final temperature T_f consider,

$$\begin{aligned} T_f &= T_i \left(\frac{V_f}{V_i} \right)^{\gamma-1} = (300 \text{ K}) (15)^{0.40} \\ &= 886 \text{ K} = 613^\circ\text{C} \end{aligned}$$

The pressure involved in this process is about 45 atm. This is an adiabatic compression. The temperature of the gas is increased without any transfer of heat. Similar heating is used in automobile (diesel) engines. The fuel used in the engine is heated rapidly to such a high temperature that it ignites without any spark plug.

(d)

(i) Pressure in isothermal process is given by

$$p_i V_i = p_f V_f$$

$$p_f = \frac{p_i V_i}{V_f} = 15 \text{ atm}$$

(ii) There will be no change in the temperature because it is an isothermal process.

(iii) Work done in isothermal process is given by

$$\begin{aligned} W &= nRT \ln \left(\frac{V_f}{V_i} \right), n = 0.405 \\ &= 0.405 \times 831 \times 300 (-0.270) \\ &= -2726 \text{ J} \end{aligned}$$

The work done during adiabatic process is very much less than the work done during isothermal process. Can you explain this? What happens to this work which is apparently 'lost'?

**Use your brain power**

- Why is the p - V curve for adiabatic process steeper than that for isothermal process?
- Explain formation of clouds at high altitude.

**Can you tell?**

When the temperature of a system is increased or decreased in an adiabatic heating or cooling, is there any transfer of heat to the system or from the system?

6. Cyclic Process:

A thermodynamic process that returns a system to its initial state is a cyclic process. In this process, the initial and the final state is the same. Figure 4.19 shows the p - V diagram of a cyclic process. For a cyclic process, the total change in the internal energy of a system is zero. ($\Delta U = 0$). According to the first law of thermodynamics, we have, for a cyclic process,

$$Q = W \quad \text{--- (4.21)}$$

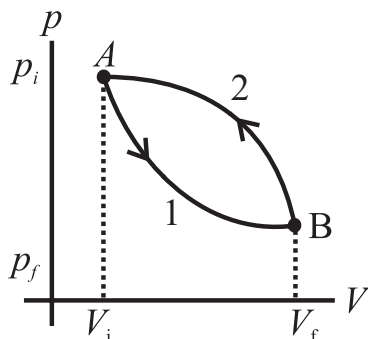

Fig. 4.19: p - V diagram of cyclic process.

**Remember this**

Working of all heat engines is a cyclic process.

Example 4.8: Cyclic process:

The total work done in the cyclic process shown in the Fig. 4.19 is -1000 J. (a) What does the negative sign mean? (b) What is the change in internal energy and the heat transferred during this process. (c) What will happen when the direction of the cycle is changed?

Solution: (a) Work done in the process from A to B along path 2 is given by the area under this curve. In this process, volume is increasing therefore the work done is positive.

Work done in the process from B to A along path 1 is given by the area under this curve. In this process volume is decreasing therefore the work done is negative.

The total work done during the complete cycle, from A to B along path 2 and from B to A along path 1 is the area enclosed by the closed loop. This is the difference between the area under the curve 1 and that under the curve 2. Since the area under curve 1 is negative and larger than the area under the curve 2, the area of the loop is also negative. That means the work is done by the system is negative.

(b) This is a cyclic process which means the initial and the final state of the system is the same. For a cyclic process $\Delta U = 0$, so $Q = W = -1000$ J. That is, 1000 joules of heat must be rejected by the system.

(c) If the direction of the cycle is changed the work done will be positive. The system will do work. From this example we conclude that: The total work done in a cyclic process is *positive* if the process is goes around the cycle in a *clockwise direction*. The total work done in a cyclic process is *negative* if the process goes around the cycle in a *counterclockwise direction*.

**Can you tell?**

1. How would you interpret the Eq. 4.21 for a cyclic process?
2. An engine works at 5000 RPM, and it performs 1000 J of work in one cycle. If the engine runs for 10 min, how much total work is done by the engine?

7. Free Expansion:

These expansions are adiabatic expansions and there is no exchange of heat between a system and its environment. Also, there is no work done on the system or by the system. $Q = W = 0$, and according to the first law of thermodynamics, $\Delta U = 0$. For example, when a balloon is ruptured suddenly, or a tyre

is suddenly punctured, the air inside rushes out rapidly but there is no displacement of a piston or any other surface. Free expansion is different than other thermodynamic processes we have discussed so far because it is an *uncontrolled change*. It is an instantaneous change and *the system is not in thermodynamic equilibrium*. A free expansion cannot be plotted on a p - V diagram. Only its initial and the final state can be plotted.

Example 4.9: A cyclic process ABCA is shown in V - T diagram (Fig (a)). It is performed with a constant mass of ideal gas. How will this transform to a p - V diagram?

Solution: Straight line form A to B on the V - T diagram means $V \propto T$, i.e., ' p ' is constant. V is constant and temperature decreases. Along B - C i.e., p should also decrease.

Temperature is constant along CA. That means it is an isothermal process. The p - V curve would look as shown in the Fig (b).

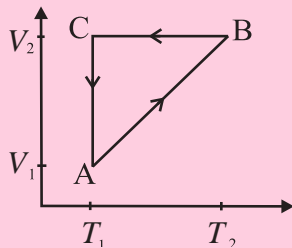

(Fig (a))

is shown in V - T diagram (Fig (a)). It is performed with a constant mass of ideal gas. How will this transform to a p - V diagram?

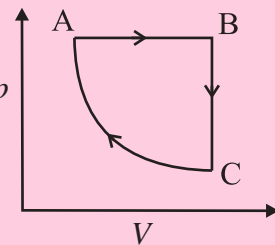

(Fig (b))

A heat engine receives heat from a source called *reservoir* and converts some of it into work. Remember that all the heat absorbed is *not* converted into work by a heat engine. Some heat is lost in the form of exhaust.

A typical heat engine has the following elements:

(1) A working substance: It is called the *system*. It can be an ideal gas for an ideal heat engine (to be discussed later). For a practical heat engine, the working substance can be a mixture of fuel vapour and air in a gasoline (petrol) or diesel engine, or steam in a steam engine. *It is the working substance that absorbs heat and does work.*

(2) Hot and cold reservoir: The working substance interacts with the reservoirs. The *hot reservoir* is the source of heat. It is at a relatively high temperature and is capable of providing large amount of heat at constant higher temperature, T_H . It is also called as the *source*. The *cold reservoir* absorbs large amount of heat from the working substance at constant lower temperature, T_C . It is also called as the *sink*.

(3) Cylinder: Generally, the working substance is enclosed in a cylinder with a moving, frictionless, and massless piston. The working substance does some work by displacing the piston in the cylinder. This displacement is transferred to the environment using some arrangement such as a crank shaft which transfers mechanical energy to the wheels of a vehicle.

Heat engines are of two basic types. They differ in the way the working substance absorbs heat. In an *external combustion engine*, the working substance is heated externally as in case of a steam engine. In case of the *internal combustion engine*, the working substance is heated internally similar to an automobile engine using gasoline or diesel.

Any heat engine works in following three basic steps.

4.8 Heat Engines:

As mentioned earlier, thermodynamics is related to study of different processes involving conversion of heat and work into each other. In this section, we will study the practical machines that convert some heat into work. These are heat engines.

4.8.1 Heat Engine:

Heat engines are devices that transform heat partly into work or mechanical energy. Heat engines work by using cyclic processes and involve thermodynamic changes. Automobile engines are familiar examples of heat engines.

1. The working substance absorbs heat from a hot reservoir at higher temperature.
2. Part of the heat absorbed by the working substance is converted into work.
3. The remaining heat is transferred to a cold reservoir at lower temperature.

Heat engines are classified according to the working substance used and the way these steps are actually implemented during its operation. Heat engines are diagrammatically represented by an energy flow diagram schematically shown in Fig. 4.20. Energy exchange takes place during various stages of working of a heat engine.

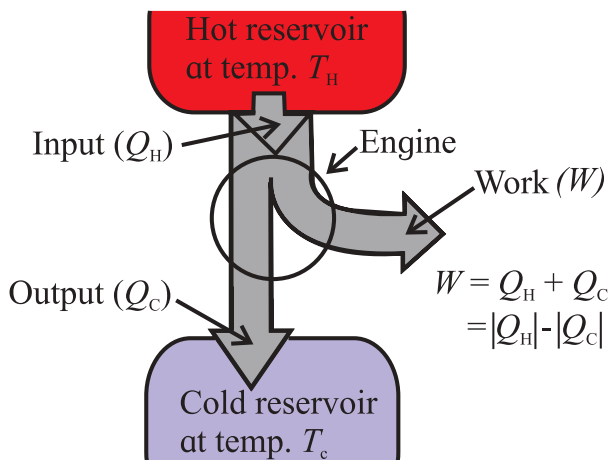

Fig. 4.20: Schematic energy flow diagram of a heat engine.

Let Q_H be the heat absorbed by the working substance at the source, and Q_C be the heat rejected by it at the sink. In a heat engine, Q_H is positive and Q_C is negative. Also, let W be the work done by the working substance.

In the Fig. 4.20, the circle represents the engine. The ‘heat pipelines’ shown in the diagram represent the heat absorbed, rejected, and converted into work. The width of the heat ‘pipeline’ indicated by Q_H , is proportional to the amount of heat absorbed at the source. Width of the branch indicated by Q_C is proportional to the magnitude $|Q_C|$ of the amount of heat rejected at the sink. Width of the branch of

the pipeline indicated by W is proportional to the part of the heat converted into mechanical work.

One single execution of the steps mentioned above is one operating ‘cycle’ of the engine. Several such cycles are repeated when a heat engine operates. The quantities Q_H and Q_C represent the amount of heat absorbed (positive) and rejected (negative) respectively during one cycle of operation.



Do you know?

The number of repetitions of the operating cycles of an automobile engine is indicated by its RPM or Revolutions Per Minute.

The net heat Q absorbed per operating cycle is,

$$Q = Q_H + Q_C = |Q_H| - |Q_C| \quad \text{--- (4.22)}$$

The net work done in one operating cycle, by the working substance, is given by using the first law of thermodynamics.

$$W = Q = |Q_H| - |Q_C| \quad \text{--- (4.23)}$$

Ideally, we would expect a heat engine to convert all the heat absorbed, Q_H , in to work. Practically, this is not possible. There is always some heat lost, i.e., $Q_C \neq 0$. The thermal efficiency η of the heat engine is defined as,

$$\eta = \frac{W}{Q_H} \quad \text{--- (4.24)}$$

Thus, the thermal efficiency, or simply, the efficiency of a heat engine is the ratio of the work done by the working substance and the amount of heat absorbed by it. It is the ratio of the output, in the form of the work done W by the engine, and the input, in the form of the heat supplied Q_H . In simple words, *efficiency of a heat engine is the fraction of the heat absorbed that is converted into work*, Eq. (4.24).

In terms of the energy flow diagram Fig. 4.20, the ‘pipeline’ representing the work is as wide as possible and the pipeline representing the exhaust is as narrow as possible for the most efficient heat engine.

There is a fundamental limit on the efficiency of a heat engine set by the second law of thermodynamics, which we will discuss later.

Using Eq. (4.22) and Eq. (4.23) we can write the efficiency of a heat engine as,

$$\eta = \frac{W}{Q_H} = 1 + \frac{Q_C}{Q_H} = 1 - \frac{|Q_C|}{|Q_H|} \quad \text{--- (4.25)}$$

Equation (4.25) gives the thermal efficiency of a heat engine. It is a ratio of the quantities which represent energy. Therefore, it has no units but, we must express W , Q_H , and Q_C in the same units.

4.8.2 The Heat Engine Cycle and the p - V Diagram:

As discussed previously, the working of a heat engine is a well defined sequence of operations. It is a cyclic thermodynamic process. We know that a thermodynamic process can be represented by a p - V diagram. We will now discuss the p - V diagram of a heat engine. Keep in mind that this is a p - V diagram of a general heat engine. There are different ways of operating a heat engine. We will discuss some such heat engines in the following sections.

A heat engine uses energy absorbed in the form of heat to do work and then rejects the heat which cannot be used to do work. Heat is absorbed in one part of the cycle, work is done in another part, and the unused heat is rejected in yet other part of the cycle. The p - V diagram of a typical heat engine is shown in Fig. (4.21).

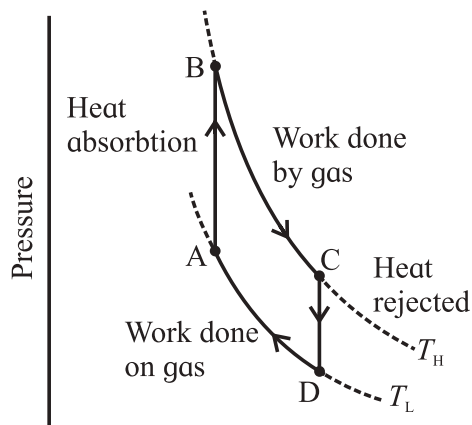

Fig. 4.21: p - V diagram of a typical heat engine.

The operating cycle begins at the point A in the cycle. The working substance, the gas in this case, absorbs heat at constant volume and no work is done by the gas or on the gas. The pressure is increased till the point B is reached. The temperature of the gas also increases and its internal energy increases.

The gas starts expanding by pushing the piston away and its volume changes from the point B to the point C. Because the gas expands, its pressure is reduced. The gas does work in this part of the cycle.

When the point C is reached, the excess heat, the heat that is not utilized in doing work by the gas, is rejected. The gas cools down and its internal energy decreases. This process is again at constant volume. The pressure of the gas is reduced and point D on the p - V diagram is reached.

The gas is now compressed. Its volume decreases and its pressure increases. The change continues till the point A is reached. The cycle is complete and the system is ready for the next cycle.

Thus, the p - V diagram is a visual tool for the study of heat engines. The working substance of a heat engine is usually a gaseous mixture. Study of the p - V diagram helps us understand the behavior of the three state variables of a gas throughout the operational cycle.

The operation of a heat engine is a cyclic process therefore, its p - V diagram is a closed loop. The area of the loop represents the work done during one complete cycle.

Since work is done by the gas, or on the gas, only when its volume changes, the p - V diagram provides a visual interpretation of the work done during one complete cycle. Similarly, the internal energy of the gas depends upon its temperature. Hence, the p - V diagram along with the temperatures calculated from the ideal gas law determines the changes in the internal energy of the gas.

We can calculate the amount of heat added or rejected from the first law of thermodynamics.

Thus, a p - V diagram helps us analyze the performance of any heat engine which uses a gas as its working substance.

4.9 Refrigerators and Heat Pumps:

So far, we have discussed a heat engine which takes heat from a source at higher temperature and rejects it to a sink at lower temperature. The input provided to the working substance (a gas or a mixture of gasoline and air) in a heat engine is in the form of heat which is converted into mechanical work as output. Figure 4.20 shows this in the form of an energy flow diagram. *Refrigerators and heat pumps are heat engines that work in backward direction. They convert mechanical work into heat.*

4.9.1 Heat Flow from a Colder Region to a Hotter Region:

According to the second law of thermodynamics (to be discussed in the next article), *heat cannot flow from a region of lower temperature to a region of higher temperature on its own.* We can force heat to flow from a region of lower temperature to a region of higher temperature by doing work on the system (or, on the working substance of a heat engine). Refrigerators or air-conditioners and heat pumps are examples of heat engines which cause heat to be transferred from a cold region to a hot region. Usually, this is achieved with the aid of *phase change* of a fluid, called the refrigerant. The refrigerant is forced to evaporate and then condense by successively decreasing and increasing its pressure. It can, therefore, ‘pump’ energy from a region at lower temperature to a region of higher temperature. It extracts the heat of vaporization of the refrigerant from the cold region and rejects it to the hotter region outside the refrigerator. This results in cooling down the cold region further.

Figure 4.22 shows the concept of transferring heat from a cold region to a hot region in a schematic way. Heat from the cold region is carried to the hot region by the refrigerant. It extracts heat from a cold region due to forced evaporation. The heat of evaporation of the refrigerant thus absorbed is rejected by compressing and condensing it into liquid at a higher temperature. All this process is carried out in a mechanism involving a compressor and closed tubing such as seen at the back of a house hold refrigerator.

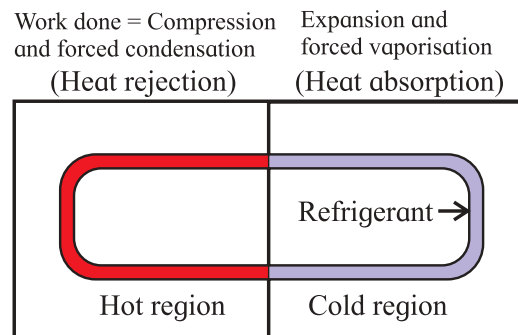

Fig. 4.22: Schematic diagram of transferring heat from a cold region to a hot region.

4.9.2 Refrigerator:

Refrigeration is a process of cooling a space or substance of a system and/or to maintain its temperature below its ambient temperature. *In simple words, refrigeration is artificial cooling.*

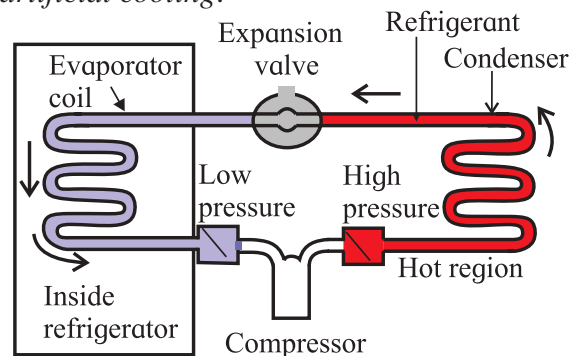

Fig. 4.23 (a): Schematics of a refrigerator.

A refrigerator extracts heat from a cold region (inside the chamber, or the compartments) and delivers it to the surrounding (the atmosphere) thus, further cooling the cold region. That's the reason why if you place your hand behind a working

refrigerator, you can feel the warm air. But the interior of the refrigerator is cold. An air conditioner also works on similar principles.

Figure 4.23 (a) shows the schematics of the mechanism used in a typical refrigerator. It consists of a compressor, an expansion valve, and a closed tube which carries the refrigerant. Part of the tube, called the cooling coil, is in the region which is to be cooled at lower temperature and lower pressure. The other part which is exposed to the surrounding (generally, the atmosphere) is at a higher temperature and higher pressure. A fluid such as (fluorinated hydrocarbons) is used as refrigerant. Normally, the cold and the hot part of the coil contain the refrigerant as a mixture of liquid and vapour phase in equilibrium.

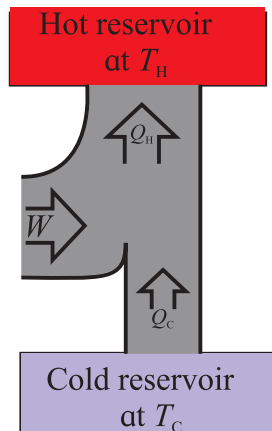

Fig. 4.23 (b): Energy flow diagram of a refrigerator.

Figure 4.23 (b) shows the energy flow diagram of a refrigerator. As you can see, the heat extracted from a cold reservoir is supplemented by the mechanical work done (on the refrigerant) by the compressor and the total energy is rejected at the hot reservoir. The refrigerant goes through the following steps in one complete cycle of refrigeration.

Step 1: The fluid passes through a nozzle and expands into a low-pressure area. Similar to the way carbon dioxide comes out of a fire extinguisher and cools down, the fluid turns into a gas and cools down. This is essentially an adiabatic expansion.

Step 2: The cool gas is in thermal contact with the inner compartment of the fridge. It heats

up as heat is transferred to it from the contents of the fridge. This takes place at constant pressure, so it's an isobaric expansion.

Step 3: The gas is transferred to a compressor, which does most of the work in this process. The gas is compressed adiabatically, heating it and turning it back to a liquid.

Step 4: The hot liquid passes through coils on the outside of the fridge, and heat is transferred to the atmosphere. This is an isobaric compression process.

The compressor is driven by an external energy source and it does the work $|W|$ on the working substance during each cycle.

4.9.3 Performance of a Refrigerator:

Consider the energy flow diagram of a refrigerator Fig. 4.23 (b). It shows the relation between the work and heat involved in transferring heat from a low temperature region to a high temperature region. This is a cyclic process in which the working substance, the refrigerant in this case, is taken back to the initial state.

For a refrigerator, the heat absorbed by the working substance is Q_C and the heat rejected by it is Q_H . A refrigerator absorbs heat at lower temperature and rejects it at higher temperature, therefore, we have, $Q_C > 0$, $Q_H < 0$, and $W < 0$. Hence, we write, $|W|$ and $|Q_H| = -Q_H$. In this case, we apply the first law of thermodynamics to the cyclic process. For a cyclic process, the internal energy of the system in the initial state and the final state is the same, therefore, from Eq. (4.21), we have,

$$Q_H + Q_C = W, \text{ or } Q_H + Q_C - W = 0$$

$$\therefore -Q_H = Q_C - W$$

For a refrigerator, $Q_H < 0$, and $W < 0$, therefore,

$$|Q_H| = |Q_C| + |W| \quad \text{---(4.26)}$$

From the Fig.4.23 (b), we realize that the heat $|Q_H|$ rejected by the working substance at the hot reservoir is always greater than the heat Q_C received by it at the cold reservoir. Note that the Eq. (4.26), derived for a refrigerator

and the Eq. (4.23), derived for a heat engine, are the same. They are valid for a heat engine and also for a refrigerator.

The ratio $\frac{|Q_c|}{|W|}$ indicates the performance of a refrigerator and is called the *coefficient of performance (CoP), K, or quality factor, or Q-value of a refrigerator*. Larger is the ratio, better is the refrigerator. That means a refrigerator has the best performance when the heat extracted by the refrigerant at the cold reservoir is maximum by doing minimum work in one operating cycle.

From Eq. (4.26), $|W| = |Q_c| - |Q_H|$

$$\therefore K = \frac{|Q_c|}{|W|} = \frac{|Q_c|}{|Q_c| - |Q_H|} \quad \text{--- (4.27)}$$

All the quantities on the right side of Eq. (4.27) represent energy and are measured in the same energy units. The coefficient of performance, K of a refrigerator is, therefore, a dimensionless number. For a typical household refrigerator, $K \approx 5$.



Remember this

Refrigerator transfers heat from inside a closed space to its external environment so that inside space is cooled to temperature below the ambient temperature.



Do you know?

Capacity of a refrigerator is expressed in litre. It is the volume available inside a refrigerator.

4.9.4 Air conditioner:

Working of an air conditioner and a refrigerator is exactly similar. It differs from a refrigerator only in the volume of the chamber/room it cools down. For an air conditioner, the evaporator coils are inside the room that is to be cooled and the condenser is outside the room. The air cooled by the evaporator coils inside the room is circulated by a fan placed inside the air conditioning unit. The performance of

an air conditioner is defined by $K = \frac{|Q_c|}{|W|}$. It is important to consider the rate of heat removed H and the power P required for removing the heat.

We define the rate of heat removed as the heat current $H = \frac{|Q_c|}{t}$, where, t is the time in which heat $|Q_c|$ is removed. Therefore, the coefficient of performance of an air conditioner can be calculated as,

$$K = \frac{|Q_c|}{|W|} = \frac{Ht}{Pt} = \frac{H}{P} \quad \text{--- (4.28)}$$

Typical values of K are 2.5 to 3.0 for room air conditioners.



Do you know?

Capacity of an air conditioner is expressed in tonne. Do you know why?

Before refrigerator and AC was invented, cooling was done by using blocks of ice. When cooling machines were invented, their capacity was expressed in terms of the equivalent amount of ice melted in a day (24 hours). The same term is used even today.

4.9.5 Heat Pump:

Heat pump is a device which works similar to a refrigerator. It is used to heat a building or a similar larger structure by cooling the air outside it. A heat pump works like a refrigerator operating inside out. In this case, the evaporator coils are outside and absorb heat from the cold air from outside. The condenser coils are inside the building. They release the absorbed heat to the air inside the thus, warming the building.



Remember this

Heat flow from a hot object to a cold object is spontaneous whereas, work is always required for the transfer of heat from a colder object to a hotter object.

4.10 Second Law of Thermodynamics:**4.10.1 Limitations of the First Law of Thermodynamics:**

The First law of thermodynamics tells us that heat can be converted into work and work can also be converted into heat. It is merely a quantitative statement of the equivalence of heat and work. It has the following limitations.

(a) It does not tell us whether any particular process can actually occur. According to the first law of thermodynamics, heat may, on its own, flow from an object at higher temperature to one at lower temperature and it can also, on its own, flow from an object at lower temperature to one at higher temperature. We know that practically, heat cannot flow from an object at lower temperature to another at higher temperature. The First law of thermodynamics does not predict this practical observation.

(b) According to the First law, we could convert all (100%) of the heat available to us into work. Similarly, all the work could be converted into heat. Again, we know that practically this is not possible.

Thus, the First law of thermodynamics does not prevent us from converting heat entirely into work or work entirely into heat. These limitations lead to the formulation of another law of thermodynamics called the Second law of thermodynamics. We will discuss this at a later stage in this chapter.

We have seen earlier in section 4.7.3 that an irreversible process defines the preferred direction of an irreversible process. It is also found that it is impossible to build a heat engine that has 100% efficiency Eq. (4.25). *That is, it is not possible to build a heat engine that can completely convert heat into work.*

Similarly, for a refrigerator it is impossible to remove heat without doing any work on a system. That is, the coefficient of performance, Eq. (4.28) of a refrigerator can never be infinite.

These practical observations form the basis of a very important principle of thermodynamics, the Second law of thermodynamics.

The Second law of thermodynamics is a general principle which puts constraints upon the direction of heat transfer and the efficiencies that a heat engine can achieve.

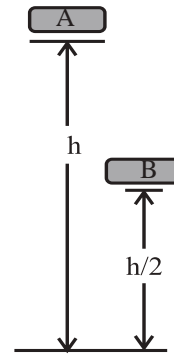
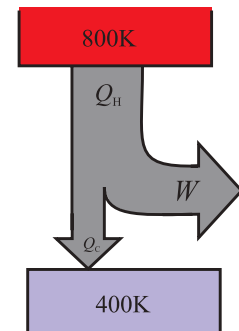

Fig. 4.24 (a): Energy of an object at two different heights.

Fig. 4.24 (b): Limitations on efficiency of a heat engine.



Consider an object A at certain height of h above the ground and another object B of the same mass a height of $h/2$ as shown in Fig. 4.24 (a). We know that potential energy of the object B is half that of the object A. That means we can extract only half the energy from the object B. Similarly, if a heat engine as shown in Fig. 4.24 (b) operates between the temperatures of 800 K and 400 K, i.e., if it receives heat at 800 K and rejects it at 400 K, its maximum efficiency can be 50%.

4.10.2 The second law of thermodynamics, statement:

We now know that heat can be converted into work by using a heat engine. However, our practical experience says that entire heat supplied to the working substance can never be converted into mechanical work. Second law of thermodynamics helps us to understand this. According to the second law of thermodynamics, *“It is impossible to extract an amount of heat Q_H from a hot reservoir and use it all to do work W . Some amount of*

heat Q_C must be exhausted to a cold reservoir. This prohibits the possibility of a perfect heat engine”.

Sometimes it is also called as the ‘Engine Law’ or the ‘Engine Statement’ of the Second law of thermodynamics.

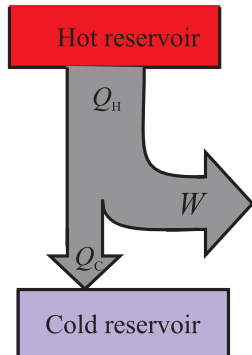

Fig. 4.25 (a): Second law of thermodynamics.

Fig. 4.25 (b): Energy flow diagram of Engine statement.

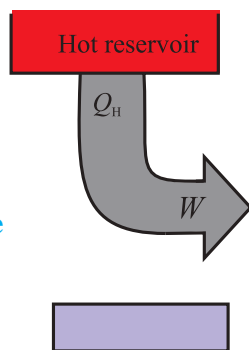

Figure 4.25 is a diagrammatic representation of the application of the Second law of thermodynamics to a heat engine. As you can see from the diagram, Fig. 4.25 (a), all heat engines lose some heat to the environment of a perfect heat engine. All the heat Q_H , extracted can not be used to do work. Figure 4.25 (b) shows the energy flow diagram for such a situation.

This form of statement of the Second law of thermodynamics is called as the **Kelvin-Planck statement** or the ‘First form’ of the Second law of thermodynamics.

We have seen how the efficiency of a heat engine is restricted by the second law of thermodynamics. Heat engine is one form of ‘heat – work conversion’. Let us see what happens in case of a refrigerator, the other form of ‘work – heat conversion’.

“It is not possible for heat to flow from a colder body to a warmer body without any work having been done to accomplish this flow”.

This means that energy will not flow spontaneously from an object at low temperature to an object at a higher temperature. This rules out the possibility of a perfect refrigerator. The statements about refrigerators are also applicable to air conditioners and heat pumps, which work on the same principles.

This is the ‘Second form’ or **Clausius statement** of the Second law of thermodynamics. Sometimes it is also called as the ‘Refrigerator Law’ or the ‘Refrigerator Statement’ of the Second law of thermodynamics.

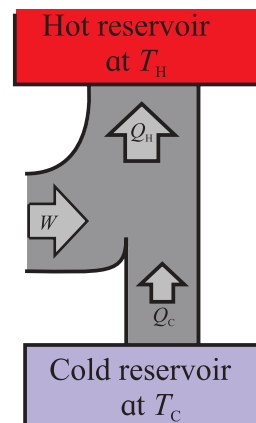

Fig. 4.26 (a): Energy flow diagram of a practical refrigerator.

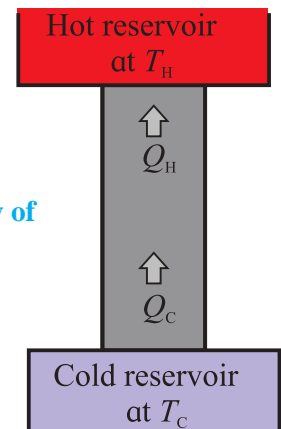

Fig. 4.26 (b): Energy flow of perfect refrigerator.

Figure 4.26 is a diagrammatic representation of the application of the Second law of thermodynamics to a refrigerator. As you can see from the energy flow diagram, Fig. 4.26 (a), a practical refrigerator requires work W to be done to extract heat Q_H from a cold reservoir and reject it to a hot reservoir. The statement means that spontaneous flow of heat from an object at cold temperature is not possible Fig. 4.26 (b).

**Remember this**

When we say that energy will not flow *spontaneously* from a cold object to a hot object, we are referring to the *net transfer of energy*. Energy can transfer from a cold object to a hot object either by transfer of energetic particles or electromagnetic radiation. However, in any spontaneous process, the net transfer of energy will be from the hot object to the cold object. *Work is required to transfer net energy from a cold object to a hot object.*

4.11 Carnot Cycle and Carnot Engine:

In section 4.7.3, we have discussed the concept of a reversible and an irreversible process at length. Now we will discuss why reversibility is such a basic and important concept in thermodynamics.

4.11.1 Significance of Reversibility in Thermodynamics:

We know that a reversible process is a ‘bidirectional’ process, i.e., it follows exactly the same steps in either direction. This requires the process to take place in infinitesimally small steps. Also, the difference between the state variables in the two infinitesimally close states should be very small. This would be possible if the system is in thermodynamic equilibrium with its environment throughout the change.

An irreversible process, on the contrary, is a unidirectional process. It can take place in only in one direction. Any irreversible process is not in thermal equilibrium with its environment.

4.11.2 Maximum Efficiency of a Heat Engine and Carnot’s Cycle:

We know that conversion of work to heat (refrigerator, section 4.9.2) is an irreversible process. A heat engine would convert maximum heat into work if all irreversible processes could be avoided. In that case, the efficiency of the heat engine can be maximum. Sadi Carnot, French engineer and scientist,

proposed a hypothetical ideal engine in 1824 which has the maximum efficiency.

In a Carnot engine, there are basically two processes:

- (i) Exchange of heat (steps A to B and C to D in the Fig. 4.21). For this to be reversible, *the heat exchange must be isothermal*. This is possible if the working substance is at the temperature T_H of the source while absorbing heat. The working substance should be at the temperature of the cold reservoir T_C , while rejecting the heat.
- (ii) Work done (steps B to C and D to A). For work done to be reversible, *the process should be adiabatic*.

Thus, the cycle includes two isothermal and two adiabatic processes for maximum efficiency. The corresponding p - V diagram will then be as shown in the Fig. 4.27.

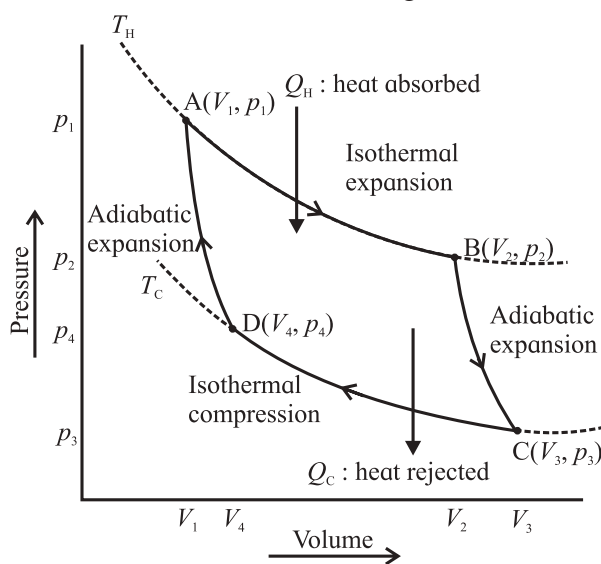

Fig. 4.27: Carnot cycle AB: Isothermal expansion, BC: Adiabatic expansion, CD: Isothermal compression, DA Adiabatic compression.

By using the expression for work done during an adiabatic and an isothermal process Eq. (4.7) and (4.20), we can derive an expression for the efficiency of a Carnot cycle/engine as,

$$\eta = \frac{W}{Q_H} = 1 - \frac{|Q_C|}{|Q_H|} = 1 - \frac{T_C}{T_H} \quad \text{--- (4.29)}$$

Thus, while designing a heat engine for maximum efficiency, the source temperature T_H should be as high as possible and the sink temperature T_C should be as low as possible.

**Use your brain power**

Suggest a practical way to increase the efficiency of a heat engine.

**Remember this****Always Remember for a Carnot Engine:**

1. Carnot engine is a hypothetical concept.
2. Every process must be either isothermal or adiabatic.
3. The system must maintain thermodynamic equilibrium throughout the cycle so that it is reversible.
4. The efficiency of a Carnot engine can never be 100% unless $T_C = 0$. We know that this is not possible practically. That means even an ideal heat engine, the Carnot engine, cannot have 100% efficiency.

4.11.2 Carnot Refrigerator:

We know that a refrigerator is nothing but a heat engine operated in the reverse direction. Because each step in the Carnot cycle is reversible, the entire Carnot cycle is reversible. If we operate the Carnot engine in the reverse direction, we get the Carnot refrigerator. Using the Eq. (4.28), we can write the coefficient of performance of a Carnot refrigerator as,

$$K = \frac{|Q_c|}{|Q_c| - |Q_H|} = \frac{|Q_c|}{1 - \frac{|Q_c|}{|Q_H|}} \quad \text{--- (4.30)}$$

Using $\frac{|Q_c|}{|Q_H|} = \frac{T_C}{T_H}$, in Eq. (4.30) we have, the coefficient of performance of a Carnot refrigerator as,

$$K = \frac{T_C}{T_H - T_C} \quad \text{--- (4.31)}$$

Equation (4.31) gives the coefficient of performance of an ideal refrigerator or, the Carnot refrigerator. It says that *the coefficient of performance of a Carnot refrigerator also*

depends on only the temperature difference of the hot and the cold reservoir. When the temperature difference is very small, the coefficient is very large. In this case, a large quantity of heat can be removed from the lower temperature to the higher temperature by doing very small amount of work. The coefficient of performance is very small when the temperature difference is large. That means a small quantity of heat will be removed even when a large amount of work is done.

Example 4.10: Carnot engine:

A Carnot engine receives 2.0 kJ of heat from a reservoir at 500 K, does some work, and rejects some heat to a reservoir at 350 K. (a) How much work does it do? (b) how much heat is rejected. (c) what is its efficiency?

Solution: The heat Q_C rejected by the engine is given by

$$\begin{aligned} Q_C &= -Q_H \frac{T_C}{T_H} = -(2000 \text{ J}) \frac{350\text{K}}{500\text{K}} \\ &= -1400 \text{ J} \end{aligned}$$

From the First law, the work W done by the engine is,

$$\begin{aligned} W &= Q_H + Q_C = 2000 \text{ J} + (-1400 \text{ J}) \\ &= 600 \text{ J} \end{aligned}$$

Efficiency of the Carnot engine is,

$$\eta = 1 - \frac{T_C}{T_H} = 1 - \frac{350\text{K}}{500\text{K}} = 0.30 = 30\%$$

Is there any simple way to calculate efficiency?

4.11.3 The Second Law of Thermodynamics and the Carnot Cycle:

"The Carnot engine is the most efficient heat engine. Also, all Carnot engines operating between the same two temperatures have the same efficiency, irrespective of the nature of the working substance".

We have made two very important statements here.

1. Carnot engine is the most efficient heat engine, and

2. Efficiency of a Carnot engine is independent of its working substance.

We can also show that “A Carnot refrigerator has a greater coefficient of performance among all the refrigerators working between the same two temperatures.”

4.12 Sterling Cycle:

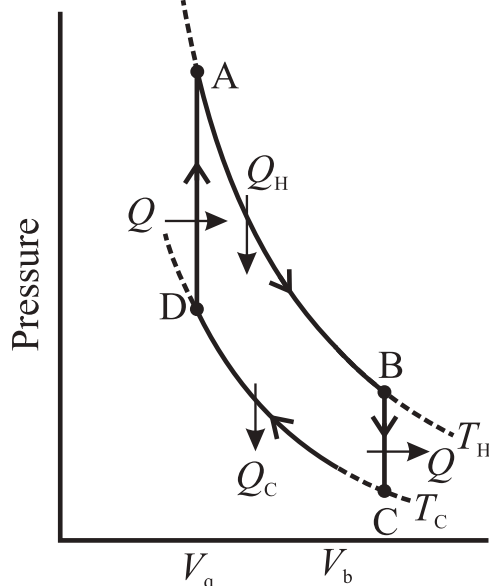

Fig. 4.28: Sterling cycle, p - V diagram.

This is a closed thermodynamic cycle. The Sterling engine is based on this cycle shown in Fig. 4.28. The working substance used in a Sterling engine is air, helium, hydrogen, nitrogen etc. All the processes in the Sterling cycle are reversible processes. When the gas is heated, the Sterling engine produces useful work. When work is done on the gas, it works as a refrigerator. This is reverse working of a Sterling cycle. The reversed Sterling cycle is extensively used in the field of cryogenics to produce extremely low temperatures or to liquefy air or gases mentioned above.

The ideal Sterling cycle has two isothermal processes AB and CD. Two isobaric processes BC and DA connect the two isothermal processes. Heat is absorbed at constant temperature T_H and rejected at constant temperature T_C . The four processes in a Sterling cycle are described briefly in the following.

- *Isothermal expansion* (AB): The gas is heated by supplying heat Q_H at constant

temperature T_H . Useful work is done by the gas in this part of the cycle.

- *Isochoric process* (BC): Part of the heat absorbed (Q_H) by the gas in the previous part of the cycle is released by the gas to the refrigerator. This heat (Q) is used in the next part of the cycle. The gas cools down to temperature T_C .
- *Isothermal compression* (CD): The heat generated in this part of the cycle (Q_C) is rejected to the coolant (sink). The temperature of the gas is maintained at T_C during this process.
- *Isobaric heat absorption* (DA): The compressed gas absorbs heat (Q) during this process. Its temperature is increased to T_H .

The cycle repeats when the process reaches the point A.



Internet my friend

1. <https://opentextbc.ca/physicstestbook2/chapter/the-first-law-of-thermodynamics/>
2. <https://opentextbc.ca/physicstestbook2/chapter/introduction-to-the-second-law-of-thermodynamics-heat-engines-and-their-efficiency/>
3. <https://opentextbc.ca/physicstestbook2/chapter/the-first-law-of-thermodynamics-and-some-simple-processes/>
4. <https://courses.lumenlearning.com/boundless-physics/chapter/introduction-8/>
5. <http://heatengine-sundervallii.blogspot.com/2010/10/everyday-examples-of-heat-engine.html>
6. <http://hyperphysics.phy-astr.gsu.edu/hbase/heacon.html#heacon>
7. <http://hyperphysics.phy-astr.gsu.edu/hbase/heacon.html>

**Exercises****1. Choose the correct option.**

- i) A gas in a closed container is heated with 10J of energy, causing the lid of the container to rise 2m with 3N of force. What is the total change in energy of the system?
(A) 10J (B) 4J
(C) -10J (D) - 4J
- ii) Which of the following is an example of the first law of thermodynamics?
(A) The specific heat of an object explains how easily it changes temperatures.
(B) While melting, an ice cube remains at the same temperature.
(C) When a refrigerator is unplugged, everything inside of it returns to room temperature after some time.
(D) After falling down the hill, a ball's kinetic energy plus heat energy equals the initial potential energy.
- iii) Efficiency of a Carnot engine is large when
(A) T_H is large (B) T_C is low
(C) $T_H - T_C$ is large (D) $T_H - T_C$ is small
- iv) The second law of thermodynamics deals with transfer of:
(A) work done (B) energy
(C) momentum (D) heat
- v) During refrigeration cycle, heat is rejected by the refrigerant in the :
(A) condenser (B) cold chamber
(C) evaporator (D) hot chamber

2. Answer in brief.

- i) A gas contained in a cylinder surrounded by a thick layer of insulating material is quickly compressed. (a) Has there been a transfer of heat? (b) Has work been done?
- ii) Give an example of some familiar process in which no heat is added to or removed from a system, but the temperature of the system changes.
- iii) Give an example of some familiar process in which heat is added to an object, without changing its temperature.
- iv) What sets the limits on efficiency of a heat engine?
- v) Why should a Carnot cycle have two isothermal two adiabatic processes?
- 3.
- i) A mixture of hydrogen and oxygen is enclosed in a rigid insulating cylinder. It is ignited by a spark. The temperature and the pressure both increase considerably. Assume that the energy supplied by the spark is negligible, what conclusions may be drawn by application of the first law of thermodynamics?
- ii) A resistor held in running water carries electric current. Treat the resistor as the system (a) Does heat flow into the resistor? (b) Is there a flow of heat into the water? (c) Is any work done? (d) Assuming the state of resistance to remain unchanged, apply the first law of thermodynamics to this process.
- iii) A mixture of fuel and oxygen is burned in a constant-volume chamber surrounded by a water bath. It was noticed that the temperature of water is increased during the process. Treating the mixture of fuel and oxygen as the system, (a) Has heat been transferred ? (b) Has work been done? (c) What is the sign of ΔU ?
- iv) Draw a p-V diagram and explain the concept of positive and negative work. Give one example each.
- v) A solar cooker and a pressure cooker both are used to cook food. Treating them as thermodynamic systems, discuss the similarities and differences between them.

4. A gas contained in a cylinder fitted with a frictionless piston expands against a constant external pressure of 1 atm from a volume of 5 litres to a volume of 10 litres. In doing so it absorbs 400 J of thermal energy from its surroundings. Determine the change in internal energy of system. [Ans: 106.65 J]
5. A system releases 125 kJ of heat while 104 kJ of work is done on the system. Calculate the change in internal energy. [Ans: $\Delta U = 21$ kJ]
6. Efficiency of a Carnot cycle is 75%. If temperature of the hot reservoir is 727°C , calculate the temperature of the cold reservoir. [Ans: 23°C]
7. A Carnot refrigerator operates between 250°K and 300°K . Calculate its coefficient of performance. [Ans: 5]
8. An ideal gas is taken through an isothermal process. If it does 2000 J of work on its environment, how much heat is added to it? [Ans: Zero]
9. An ideal monatomic gas is adiabatically compressed so that its final temperature is twice its initial temperature. What is the ratio of the final pressure to its initial pressure? [Ans: 5.6]
10. A hypothetical thermodynamic cycle is shown in the figure. Calculate the work done in 25 cycles.

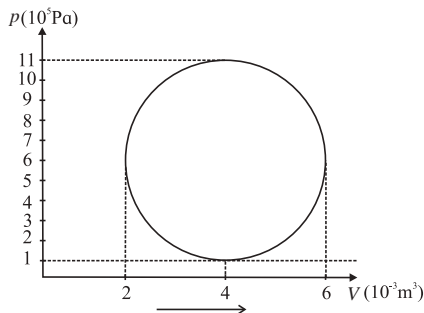

[Ans: 7.85×10^4 J]

11. The figure shows the $V-T$ diagram for one cycle of a hypothetical heat engine which uses the ideal gas. Draw (a) the $p-V$ diagram and $p-T$ diagram of the system.

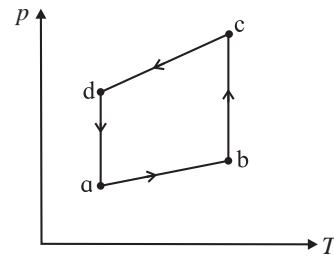
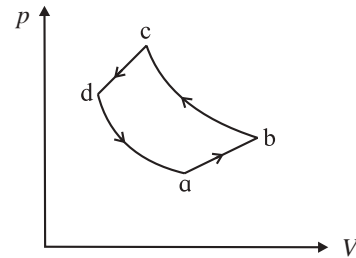
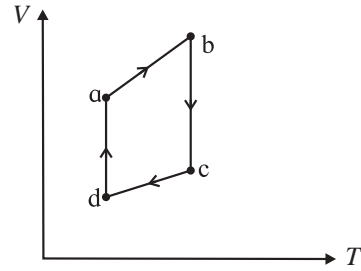

[Ans: (a)]

[Ans: (b)]

12. A system is taken to its final state from initial state in hypothetical paths as shown figure calculate the work done in each case.

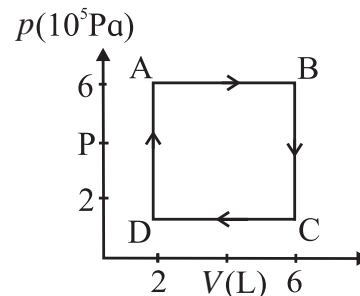

[Ans: $AB = 2.4 \times 10^6$ J, $CD = 8 \times 10^5$ J, BC and DA zero, because constant volume change]

5. Oscillations



Can you recall?

1. What do you mean by linear motion and angular motion?
2. Can you give some practical examples of oscillations in our daily life?
3. What do you know about restoring force?
4. All musical instruments make use of oscillations, can you identify, where?
5. Why does a ball floating on water bobs up and down, if pushed down and released?

5.1 Introduction:

Oscillation is a very common and interesting phenomenon in the world of Physics. In our daily life we come across various examples of oscillatory motion, like rocking of a cradle, swinging of a swing, motion of the pendulum of a clock, the vibrations of a guitar or violin string, up and down motion of the needle of a sewing machine, the motion of the prongs of a vibrating tuning fork, oscillations of a spring, etc. In these cases, the motion repeated after a certain interval of time is a periodic motion. Here the motion of an object is mostly to and fro or up and down.

Oscillatory motion is a periodic motion. In this chapter, we shall see that the displacement, velocity and acceleration for this motion can be represented by sine and cosine functions. These functions are known as harmonic functions. Therefore, an oscillatory motion obeying such functions is called harmonic motion. After studying this chapter, you will be able to understand the use of appropriate terminology to describe oscillations, simple harmonic motion (S.H.M.), graphical representations of S.H.M., energy changes during S.H.M., damping of oscillations, resonance, etc.

5.2 Explanation of Periodic Motion:

Any motion which repeats itself after

a definite interval of time is called periodic motion. A body performing periodic motion goes on repeating the same set of movements. The time taken for one such set of movements is called its period or periodic time. At the end of each set of movements, the state of the body is the same as that at the beginning. Some examples of periodic motion are the motion of the moon around the earth and the motion of other planets around the sun, the motion of electrons around the nucleus, etc. As seen in Chapter 1, the uniform circular motion of any object is thus a periodic motion.

Another type of periodic motion in which a particle repeatedly moves to and fro along the same path is the *oscillatory* or *vibratory motion*. Every oscillatory motion is periodic but every periodic motion need not be oscillatory. Circular motion is periodic but it is not oscillatory.

The simplest form of oscillatory periodic motion is the simple harmonic motion in which every particle of the oscillating body moves to and fro, about its mean position, along a certain fixed path. If the path is a straight line, the motion is called *linear simple harmonic motion* and if the path is an arc of a circle, it is called *angular simple harmonic motion*. The smallest interval of time after which the to and fro motion is repeated is called its period (T) and the number of oscillations completed per unit time is called the frequency (n) of the periodic motion.



Can you tell?

Is the motion of a leaf of a tree blowing in the wind periodic?

5.3 Linear Simple Harmonic Motion (S.H.M.):

Place a rectangular block on a smooth frictionless horizontal surface. Attach one end

of a spring to a rigid wall and the other end to the block as shown in Fig. 5.1. Pull the block of mass m towards the right and release it. The block will begin its to and fro motion on either side of its equilibrium position. This motion is linear simple harmonic motion.

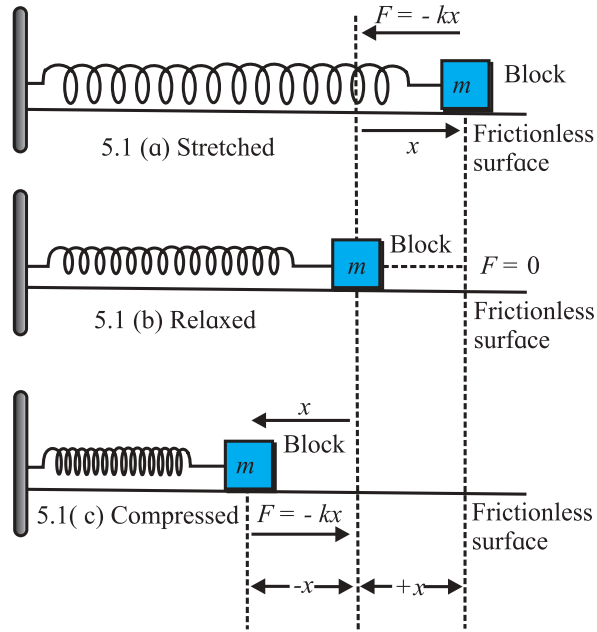

Fig. 5.1 (a), (b) and (c): Spring mass oscillator.



Remember this

For such a motion, as a convention, we shall always measure the displacement from the mean position. Also, as the entire motion is along a single straight line, we need not use vector notation (only \pm signs will be enough).

Fig. 5.1(b) shows the equilibrium position in which the spring exerts no force on the block. If the block is displaced towards the right from its equilibrium position, the force exerted by the spring on the block is directed towards the left [Fig. 5.1(a)]. On account of its elastic properties, the spring tends to regain its original shape and size and therefore it exerts a restoring force on the block. This is responsible to bring it back to the original position. This force is proportional to the displacement but its direction is opposite to that of the displacement. If x is the displacement, the restoring force f is given by,

$$f = -kx \quad \text{--- (5.1)}$$

where, k is a constant that depends upon the elastic properties of the spring. It is called the *force constant*. The negative sign indicates that the force and displacement are oppositely directed.

If the block is displaced towards left from its equilibrium position, the force exerted by the spring on the block is directed towards the right and its magnitude is proportional to the displacement from the mean position. (Fig. 5.1(c))

Thus, $f = -kx$ can be used as the equation of motion of the block.

Now if the block is released from the rightmost position, the restoring force exerted by the spring accelerates it towards its equilibrium position. The acceleration (a) of the block is given by,

$$a = \frac{f}{m} = -\left(\frac{k}{m}\right)x \quad \text{--- (5.2)}$$

where, m is mass of the block. This shows that the acceleration is also proportional to the displacement and its direction is opposite to that of the displacement, i.e., the force and acceleration are both directed towards the mean or equilibrium position.

As the block moves towards the mean position, its speed starts increasing due to its acceleration, but its displacement from the mean position goes on decreasing. When the block returns to its mean position, the displacement and hence force and acceleration are zero. The speed of the block at the mean position becomes maximum and hence its kinetic energy attains its maximum value. Thus, the block does not stop at the mean position, but continues to move beyond the mean position towards the left. During this process, the spring is compressed and it exerts a restoring force on the block towards right. Once again, the force and displacement are oppositely directed. This opposing force retards the motion of the block, so that the

speed goes on reducing and finally it becomes zero. This position is shown in Fig. 5.1(c). In this position the displacement from the mean position and restoring force are maximum. This force now accelerates the block towards the right, towards the equilibrium position. The process goes on repeating that causes the block to oscillate on either side of its equilibrium (mean) position. Such oscillatory motion along a straight path is called linear simple harmonic motion (S.H.M.). *Linear S.H.M. is defined as the linear periodic motion of a body, in which force (or acceleration) is always directed towards the mean position and its magnitude is proportional to the displacement from the mean position.*



Use your brain power

If there is friction between a block and the resting surface, how will it govern the motion of the block?



Remember this

A complete oscillation is when the object goes from one extreme to other and back to the initial position.

The conditions required for simple harmonic motion are:

1. Oscillation of the particle is about a fixed point.
2. The net force or acceleration is always directed towards the fixed point.
3. The particle comes back to the fixed point due to restoring force.

Harmonic oscillation is that oscillation which can be expressed in terms of a single harmonic function, such as $x = a \sin \omega t$ or $x = a \cos \omega t$

Non-harmonic oscillation is that oscillation which cannot be expressed in terms of single harmonic function. It may be a combination of two or more harmonic oscillations such as $x = a \sin \omega t + b \sin 2\omega t$, etc.



Activity

Some experiments described below can be performed in the classroom to demonstrate S.H.M. Try to write their equations.

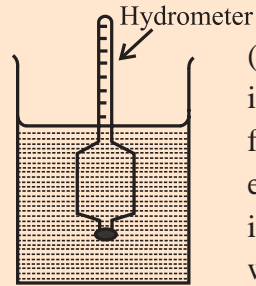

(a) A hydrometer is immersed in a glass jar filled with water. In the equilibrium position it floats vertically in water. If it is slightly

depressed and released, it bobs up and down performing linear S.H.M.

(b) A U-tube is filled with a sufficiently long column of mercury. Initially when both the

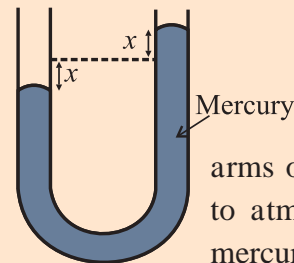

arms of U tube are exposed to atmosphere, the level of mercury in both the arms

is the same. Now, if the level of mercury in one of the arms is depressed slightly and released, the level of mercury in each arm starts moving up and down about the equilibrium position, performing linear S.H.M.

5.4 Differential Equation of S.H.M. :

In a linear S.H.M., the force is directed towards the mean position and its magnitude is directly proportional to the displacement of the body from mean position. As seen in Eq. (5.1),

$$f = -kx$$

where k is force constant and x is displacement from the mean position.

According to Newton's second law of motion,

$$f = ma \quad \therefore ma = -kx \quad \text{--- (5.3)}$$

The velocity of the particle is, $v = \frac{dx}{dt}$

and its acceleration, $a = \frac{dv}{dt} = \frac{d^2x}{dt^2}$

Substituting it in Eq. (5.3), we get

$$m \frac{d^2x}{dt^2} = -kx$$

$$\therefore \frac{d^2x}{dt^2} + \frac{k}{m}x = 0 \quad \text{--- (5.4)}$$

Substituting $\frac{k}{m} = \omega^2$, where ω is the angular frequency,

$$\frac{d^2x}{dt^2} + \omega^2x = 0 \quad \text{--- (5.5)}$$

Eq. (5.5) is the differential equation of linear S.H.M.



Can you tell?

Why is the symbol ω and also the term angular frequency used for a linear motion?

Example 5.1 A body of mass 0.2 kg performs linear S.H.M. It experiences a restoring force of 0.2 N when its displacement from the mean position is 4 cm. Determine (i) force constant (ii) period of S.H.M. and (iii) acceleration of the body when its displacement from the mean position is 1 cm.

Solution: (i) Force constant,

$$k = f/x$$

$$= (0.2)/0.04 = 5 \text{ N/m}$$

(ii) Period $T = 2\pi / \omega$

$$= 2\pi \sqrt{\frac{m}{k}} = 2\pi \sqrt{\frac{0.2}{5}} = 0.4\pi \text{ s}$$

(iii) Acceleration

$$a = -\omega^2x = -\frac{k}{m}x = -\frac{5}{0.2} \times 0.04 = -1 \text{ m s}^{-2}$$

5.5 Acceleration (a), Velocity (v) and Displacement (x) of S.H.M. :

We can obtain expressions for the acceleration, velocity and displacement of a particle performing S.H.M. by solving the differential equation of S.H.M. in terms of displacement x and time t .

From Eq. (5.5), we have $\frac{d^2x}{dt^2} + \omega^2x = 0$

$$\therefore \frac{d^2x}{dt^2} = -\omega^2x \quad \text{--- (5.6)}$$

But $a = \frac{d^2x}{dt^2}$ is the acceleration of the particle performing S.H.M.

$$\therefore a = -\omega^2x \quad \text{--- (5.7)}$$

This is the expression for acceleration in terms of displacement x .

From Eq. (5.6), we have $\frac{d^2x}{dt^2} = -\omega^2x$

$$\therefore \frac{d}{dt} \left(\frac{dx}{dt} \right) = -\omega^2x$$

$$\therefore \frac{dv}{dt} = -\omega^2x$$

$$\therefore \frac{dv}{dx} \frac{dx}{dt} = -\omega^2x$$

$$\therefore v \frac{dv}{dx} = -\omega^2x$$

$$\therefore v dv = -\omega^2x dx$$

Integrating both the sides, we get

$$\int v dv = -\omega^2 \int x dx$$

$$\therefore \frac{v^2}{2} = -\frac{\omega^2x^2}{2} + C, \quad \text{--- (5.8)}$$

where C is the constant of integration.

Let A be the maximum displacement (amplitude) of the particle in S.H.M.

When the particle is at the extreme position, velocity (v) is zero.

Thus, at $x = \pm A$, $v = 0$

Substituting in Eq. (5.8), we get

$$0 = -\frac{\omega^2A^2}{2} + C$$

$$\therefore C = +\frac{\omega^2A^2}{2} \quad \text{--- (5.9)}$$

Using C in Eq. (5.8), we get

$$\frac{v^2}{2} = -\frac{\omega^2x^2}{2} + \frac{\omega^2A^2}{2}$$

$$\therefore v^2 = \omega^2(A^2 - x^2)$$

$$\therefore v = \pm \omega \sqrt{A^2 - x^2} \quad \text{--- (5.10)}$$

This is the expression for the velocity of a particle performing linear S.H.M. in terms of displacement x .

Substituting $v = \frac{dx}{dt}$ in Eq. (5.10), we get

$$\frac{dx}{dt} = \omega\sqrt{A^2 - x^2}$$

$$\therefore \frac{dx}{\sqrt{A^2 - x^2}} = \omega dt$$

Integrating both the sides, we get

$$\int \frac{dx}{\sqrt{A^2 - x^2}} = \omega \int dt$$

$$\sin^{-1}\left(\frac{x}{A}\right) = \omega t + \phi \quad \text{--- (5.11)}$$

Here ϕ is the constant of integration. To know ϕ , we need to know the value of x at any instance of time t , most convenient being $t = 0$.

$$\therefore x = A \sin(\omega t + \phi) \quad \text{--- (5.12)}$$

This is the general expression for the displacement (x) of a particle performing linear S.H.M. at time t . Let us find expressions for displacement for two particular cases.

Case (i) If the particle starts S.H.M. from the mean position, $x = 0$ at $t = 0$

Using Eq. (5.11), we get $\phi = \sin^{-1}\left(\frac{x}{A}\right) = 0$ or π

Substituting in Eq. (5.12), we get

$$x = \pm A \sin(\omega t) \quad \text{--- (5.13)}$$

This is the expression for displacement at any instant if the particle starts S.H.M. from the mean position. Positive sign to be chosen if it starts towards positive and negative sign for starting towards negative.

Case (ii) If the particle starts S.H.M. from the extreme position, $x = \pm A$ at $t = 0$

$$\therefore \phi = \sin^{-1}\left(\frac{x}{A}\right) = \frac{\pi}{2} \text{ or } \frac{3\pi}{2}$$

Substituting in Eq. (5.12), we get

$$x = A \sin\left(\omega t + \frac{\pi}{2}\right) \text{ or } x = A \sin\left(\omega t + \frac{3\pi}{2}\right)$$

$$\therefore x = \pm A \cos(\omega t) \quad \text{--- (5.14)}$$

This is the expression for displacement at any instant, if the particle starts S.H.M. from the extreme position. Positive sign for starting from positive extreme position and negative sign for starting from the negative extreme position.

In the cases (i) and (ii) above, we have used the phrase, “if the particle starts S.H.M.....” More specifically, it is not the particle that starts its S.H.M., but we (the observer) start counting the time t from that instant. The particle is already performing its motion. We start recording the time as per our convenience. In other words, $t = 0$ (or initial condition) is always subjective to the observer.

Expressions of displacement (x), velocity (v) and acceleration (a) at time t :

From Eq. (5.12), $x = A \sin(\omega t + \phi)$

$$\therefore v = \frac{dx}{dt} = A\omega \cos(\omega t + \phi)$$

$$\therefore a = \frac{dv}{dt} = A\omega^2 \sin(\omega t + \phi)$$

Example 5.2: A particle performs linear S.H.M. of period 4 seconds and amplitude 4 cm. Find the time taken by it to travel a distance of 1 cm from the positive extreme position.

Solution: $x = A \sin(\omega t + \phi)$

Since particle performs S.H.M. from positive extreme position, $\phi = \frac{\pi}{2}$ and from data

$$x = A - 1 = 3 \text{ cm}$$

$$\therefore 3 = 4 \sin\left(\frac{2\pi}{T}t + \frac{\pi}{2}\right)$$

$$\therefore \frac{3}{4} = \cos \frac{2\pi}{4}t = \cos \frac{\pi}{2}t$$

$$\therefore \frac{\pi}{2}t = 41.4^\circ = \left(41.4 \times \frac{\pi}{180}\right)^\circ \therefore t = 0.46 \text{ s}$$

$$\left[\text{Or, } \frac{180}{2}t = 41.4 \therefore t = 0.46 \text{ s} \right]$$

Example 5.3: A particle performing linear S.H.M. with period 6 second is at the positive extreme position at $t = 0$. The particle is found to be at a distance of 3 cm from this position at time $t = 7\text{s}$, before reaching the mean position. Find the

amplitude of S.H.M.

Solution: $x = A \sin(\omega t + \phi)$

Since particle starts ($t = 0$) from positive extreme position, $\phi = \pi/2$ and $x = A - 3$

$$\therefore x = A \sin\left(\omega t + \frac{\pi}{2}\right)$$

$$\therefore A - 3 = A \sin\left(\frac{2\pi}{T} t + \frac{\pi}{2}\right)$$

$$\therefore \frac{A - 3}{A} = \sin\left(\frac{2\pi}{6} \times 7 + \frac{\pi}{2}\right)$$

$$\therefore \frac{A - 3}{A} = \sin\left(\frac{7\pi}{3} + \frac{\pi}{2}\right)$$

$$\therefore \frac{A - 3}{A} = \sin\left(\frac{\pi}{3} + \frac{\pi}{2}\right) = \cos \frac{\pi}{3} = \frac{1}{2}$$

$$\therefore 2A - 6 = A$$

$$\therefore A = 6 \text{ cm}$$

Example 5.4: The speeds of a particle performing linear S.H.M. are 8 cm/s and 6 cm/s at respective displacements of 6 cm and 8 cm. Find its period and amplitude.

Solution:

$$v = \omega \sqrt{(A^2 - x^2)}$$

$$\therefore \frac{8}{6} = \frac{\omega \sqrt{(A^2 - 6^2)}}{\omega \sqrt{(A^2 - 8^2)}} \text{ or } \frac{4}{3} = \frac{\omega \sqrt{(A^2 - 36)}}{\omega \sqrt{(A^2 - 64)}}$$

$$\therefore A = 10 \text{ cm}$$

$$v_1 = \omega \sqrt{(A^2 - x_1^2)}$$

$$\therefore 8 = \frac{2\pi}{T} \sqrt{(10^2 - 6^2)} \therefore 8 = \frac{2\pi}{T} 8$$

$$\therefore T = 6.28 \text{ s}$$

Extreme values of displacement (x), velocity (v) and acceleration (a):

1) Displacement: The general expression for displacement x in S.H.M. is $x = A \sin(\omega t + \phi)$

At the mean position, $(\omega t + \phi) = 0$ or π

$$\therefore x_{\min} = 0.$$

Thus, at the mean position, the displacement of the particle performing S.H.M. is minimum (i.e. zero).

At the extreme position, $(\omega t + \phi) = \frac{\pi}{2}$ or $\frac{3\pi}{2}$

$$\therefore x = A \sin(\omega t + \phi)$$

$$\therefore x = \pm A \sin \frac{\pi}{2} \therefore x_{\max} = \pm A$$

Thus, at the extreme position the displacement of the particle performing S.H.M. is maximum.

2) Velocity: According to Eq. (5.10) the magnitude of velocity of the particle performing S.H.M. is $v = \pm \omega \sqrt{A^2 - x^2}$

At the mean position, $x = 0 \therefore v_{\max} = \pm A\omega$.

Thus, the velocity of the particle in S.H.M. is maximum at the mean position.

At the extreme position, $x = \pm A \therefore v_{\min} = 0$.

Thus, the velocity of the particle in S.H.M. is minimum at the extreme positions.

3) Acceleration: The magnitude of the acceleration of the particle in S.H.M. is $\omega^2 x$

At the mean position $x = 0$, so that the acceleration is minimum. $\therefore a_{\min} = 0$.

At the extreme positions $x = \pm A$, so that the acceleration is maximum $a_{\max} = \mp \omega^2 A$



Can you tell?

1. State at which point during an oscillation the oscillator has zero velocity but positive acceleration?
2. During which part of the simple harmonic motion velocity is positive but the displacement is negative, and vice versa?
3. During which part of the oscillation the two are along the same direction?

Example 5.5: The maximum velocity of a particle performing S.H.M. is 6.28 cm/s. If the length of its path is 8 cm, calculate its period.

Solution:

$$v_{\max} = 6.28 \frac{\text{cm}}{\text{s}} = 2\pi \frac{\text{cm}}{\text{s}} \text{ and } A = 4 \text{ cm}$$

$$v_{\max} = A\omega = A \frac{2\pi}{T}$$

$$\therefore 2\pi = 4 \frac{2\pi}{T}$$

$$\therefore T = 4 \text{ s}$$

Example 5.6: The maximum speed of a particle performing linear S.H.M is 0.08 m/s. If its maximum acceleration is 0.32 m/s², calculate its (i) period and (ii) amplitude.

Solution:

$$(i) \frac{a_{\max}}{v_{\max}} = \frac{A\omega^2}{A\omega} = \omega = \frac{2\pi}{T} \therefore \frac{0.32}{0.08} = \frac{2\pi}{T}$$

$$\therefore T = 1.57 \text{ s}$$

$$(ii) v_{\max} = A\omega = A \frac{2\pi}{T} \therefore A = 2 \text{ cm}$$

5.6: Amplitude(A), Period(T) and Frequency (n) of S.H.M. :

5.6.1 Amplitude of S.H.M.:

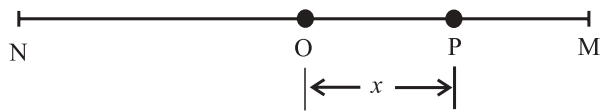

Fig. 5.2 S.H.M. of a particle.

Consider a particle P performing S.H.M. along the straight line MN (Fig. 5.2). The centre O of MN is the mean position of the particle.

The displacement of the particle as given by Eq. (5.12) is $x = A \sin(\omega t + \phi)$

The particle will have its maximum displacement when $\sin(\omega t + \phi) = \pm 1$, i.e., when $x = \pm A$. This distance A is called the amplitude of S.H.M.

The maximum displacement of a particle performing S.H.M. from its mean position is called the amplitude of S.H.M.

5.6.2 Period of S.H.M.:

The time taken by the particle performing S.H.M. to complete one oscillation is called the period of S.H.M.

Displacement of the particle at time t is given by $x = A \sin(\omega t + \phi)$

After a time $t = \left(t + \frac{2\pi}{\omega}\right)$ the displacement will be

$$x = A \sin \left[\omega \left(t + \frac{2\pi}{\omega} \right) + \phi \right]$$

$$\therefore x = A \sin(\omega t + 2\pi + \phi)$$

$$\therefore x = A \sin(\omega t + \phi)$$

This result shows that the particle is at the same position after a time $\frac{2\pi}{\omega}$. That means, the particle completes one oscillation in time $\frac{2\pi}{\omega}$. It can be shown that $t = T = \frac{2\pi}{\omega}$ is the minimum time after which it repeats.

Hence its period T is given by $T = \frac{2\pi}{\omega}$

From Eq.(5.4) and Eq.(5.5)

$$\omega^2 = \frac{k}{m} = \frac{\text{force per unit displacement}}{\text{mass}}$$

= acceleration per unit displacement

$$\therefore T = \frac{2\pi}{\sqrt{\text{acceleration per unit displacement}}}$$

$$\text{Also, } T = 2\pi \sqrt{\frac{m}{k}} \quad \text{--- (5.15)}$$

5.6.3 Frequency of S.H.M.:

The number of oscillations performed by a particle performing S.H.M. per unit time is called the frequency of S.H.M.

In time T, the particle performs one oscillation. Hence in unit time it performs $\frac{1}{T}$ oscillations.

Hence, frequency n of S.H.M. is given by

$$n = \frac{1}{T} = \frac{\omega}{2\pi} = \frac{1}{2\pi} \sqrt{\frac{k}{m}} \quad \text{--- (5.16)}$$

Combination of springs: A number of springs of different spring constants can be combined in series (Figure A) or in parallel (Figure B) or both.

Series combination (Figure A): In this case, all the springs are connected one after the other forming a single chain. Consider an arrangement of two such springs of spring constants k_1 and k_2 . If the springs are massless, each will have the same stretching force as f. For vertical arrangement, it will be the weight mg. If e_1 and e_2 are the respective extensions, we can write,

$$f = k_1 e_1 = k_2 e_2 \therefore e_1 = \frac{f}{k_1} \text{ and } e_2 = \frac{f}{k_2}$$

The total extension is

$$e = e_1 + e_2 = f \left(\frac{1}{k_1} + \frac{1}{k_2} \right).$$

If k_s is the effective spring constant (as if there is a single spring that gives the same total extension for the same force), we can write,

$$e = \frac{f}{k_s} = f \left(\frac{1}{k_1} + \frac{1}{k_2} \right) \therefore \frac{1}{k_s} = \frac{1}{k_1} + \frac{1}{k_2}$$

For a number of such (massless) springs, in series, $\frac{1}{k_s} = \frac{1}{k_1} + \frac{1}{k_2} + \dots = \sum_i \left(\frac{1}{k_i} \right)$

For only two massless springs of spring constant k each, in series,

$$k_s = \frac{k_1 k_2}{k_1 + k_2} = \frac{\text{Product}}{\text{Sum}}$$

For n such identical massless springs, in series, $k_s = \frac{k}{n}$

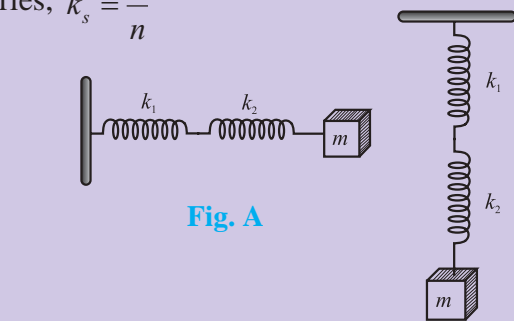

Fig. A

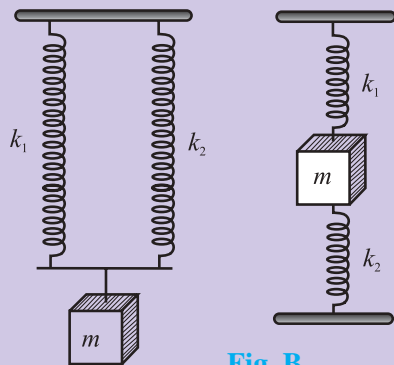

Fig. B

Parallel combination (Figure B): In such a combination, all the springs are connected between same two points, one of them is the support and at the other end, the stretching force f is applied at a *suitable* point. Irrespective of their spring constants, each spring will now have the same extension e . The springs now share the force such that in the equilibrium position, the total restoring force is equal and opposite to the stretching force f .

Let $f_1 = k_1 e, f_2 = k_2 e, \dots$ be the individual restoring forces.

If k_p is the effective spring constant, a single spring of this spring constant will be stretched by the same extension e , by the same stretching force f .

$$\therefore f = k_p e = f_1 + f_2 + \dots = k_1 e + k_2 e + \dots$$

$$\therefore k_p = k_1 + k_2 + \dots = \sum k_i$$

For m such identical massless springs of spring constant k each, in parallel, $k_p = mk$

5.7 Reference Circle Method:

Figure 5.3 shows a rod rotating along a vertical circle in the x - y plane. If the rod is illuminated parallel to x -axis from either side by a linear source parallel to the rod, as shown in the Fig. 5.3, the shadow (projection) of the rod will be produced on the y -axis. The tip of this shadow can be seen to be oscillating about the origin, along the y -axis.

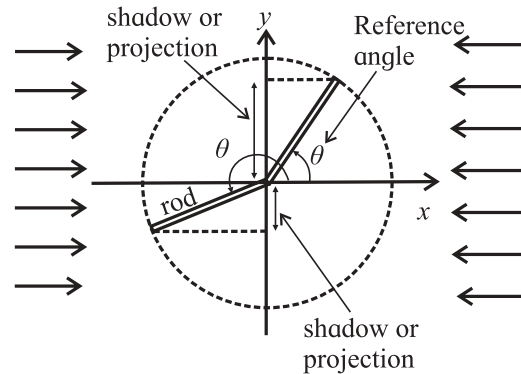

Fig 5.3: Projection of a rotating rod.

We shall now prove that motion of the tip of the projection is an S.H.M. if the corresponding motion of the tip of the rod is a U.C.M. For this, we should take the projections of displacement, velocity, etc. on *any* reference diameter and confirm that we get the corresponding quantities for a linear S.H.M.

Figure 5.4 shows the anticlockwise uniform circular motion of a particle P, with centre at the origin O. Its angular positions are decided with the reference OX. It means, if the particle is at E, the angular position is zero, at

F it is $90^\circ = \frac{\pi}{2}$, at G it is $180^\circ = \pi$, and so on. If it comes to E again, it will be $360^\circ = 2\pi$ (and not zero). Let $\vec{r} = OP$ be the position vector of this particle.

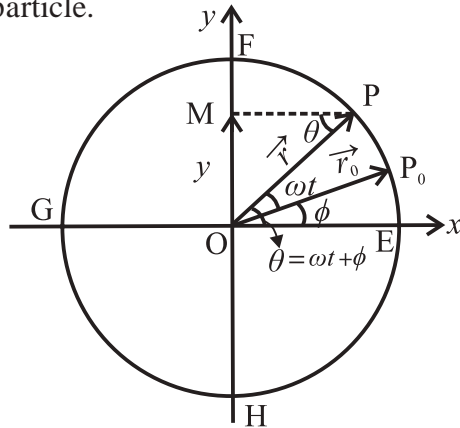

Fig 5.4: S.H.M. as projection of a U.C.M.

At $t = 0$, let the particle be at P_0 with reference angle ϕ . During time t , it has angular displacement ωt . Thus, the reference angle at time t is $\theta = (\omega t + \phi)$. Let us choose the diameter FH along y-axis as the reference diameter and label OM as the projection of $\vec{r} = OP$ on this.

Projection of displacement: At time t , we get the projection or the position vector $OM = OP \sin \theta = y = r \sin(\omega t + \phi)$. This is the equation of linear S.H.M. of amplitude r . The term ω can thus be understood as the angular velocity of the reference circular motion. For linear S.H.M. we may call it the *angular frequency* as it decides the periodicity of the S.H.M. In the next section, you will come to know that the phase angle $\theta = (\omega t + \phi)$ of the circular motion can be used to be the phase of the corresponding S.H.M.

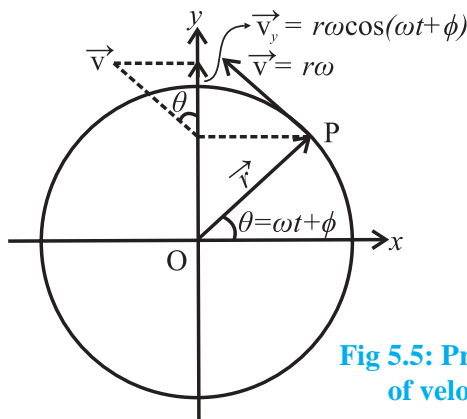

Fig 5.5: Projection of velocity.

Projection of velocity: Instantaneous velocity of the particle P in the circular motion is the tangential velocity of magnitude $r\omega$ as shown in the Fig. 5.5.

Its projection on the reference diameter will be $v_y = r\omega \cos \theta = r\omega \cos(\omega t + \phi)$. This is the expression for the velocity of a particle performing a linear S.H.M.

Projection of acceleration: Instantaneous acceleration of the particle P in circular motion is the radial or centripetal acceleration of magnitude $r\omega^2$, directed towards O. Its projection on the reference diameter will be $a_y = -r\omega^2 \sin \theta = -r\omega^2 \sin(\omega t + \phi) = -\omega^2 y$.

Again, this is the corresponding acceleration for the linear S.H.M.

From this analogy it is clear that projection of any quantity for a uniform circular motion gives us the corresponding quantity of linear S.H.M. This analogy can be verified for any diameter as the reference diameter. Thus, the projection of a U.C.M. on any diameter is an S.H.M.

5.8 Phase in S.H.M.:

Phase in S.H.M. (or for any motion) is basically the state of oscillation. In order to know the state of oscillation in S.H.M., we need to know the displacement (position), the direction of velocity and the oscillation number (during which oscillation) at that instant of time. Knowing only the displacement is not enough, because at a given position there are two possible directions of velocity (except the extreme positions), and it repeats for successive oscillations. Knowing only velocity is not enough because there are two different positions for the same velocity (except the mean position). Even after this, both these repeat for the successive oscillations.

Hence, to know the phase, we need a quantity that is continuously changing with time. It is clear that all the quantities of linear S.H.M. (x , v , a etc) are the projections taken

on a diameter, of the respective quantities for the reference circular motion. The angular displacement $\theta = (\omega t + \phi)$ can thus be used as the phase of S.H.M. as it varies continuously with time. In this case, it will be called as the *phase angle*.

Special cases:

- (i) Phase $\theta = 0$ indicates that the particle is at the mean position, moving to the positive, during the beginning of the first oscillation. Phase angle $\theta = 360^\circ$ or $2\pi^\circ$ is the beginning of the second oscillation, and so on for the successive oscillations.
- (ii) Phase $\theta = 180^\circ$ or π° indicates that during its first oscillation, the particle is at the mean position and moving to the negative. Similar state in the second oscillation will have phase $\theta = (360 + 180)^\circ$ or $(2\pi + \pi)^\circ$, and so on for the successive oscillations.
- (iii) Phase $\theta = 90^\circ$ or $\left(\frac{\pi}{2}\right)^\circ$ indicates that the particle is at the positive extreme position during first oscillation. For the second oscillation it will be $\theta = (360 + 90)^\circ$ or $\left(2\pi + \frac{\pi}{2}\right)^\circ$, and so on for the successive oscillations.
- (iv) Phase $\theta = 270^\circ$ or $\left(\frac{3\pi}{2}\right)^\circ$ indicates that the particle is at the negative extreme position during the first oscillation. For the second oscillation it will be $\theta = (360 + 270)^\circ$ or $\left(2\pi + \frac{3\pi}{2}\right)^\circ$, and so on for the successive oscillations.

Example 5.7: Describe the state of oscillation if the phase angle is 1110° .

Solution: $1110^\circ = 3 \times 360^\circ + 30^\circ$
 $3 \times 360^\circ$ plus something indicates 4th oscillation. Now, $A \sin 30^\circ = \frac{A}{2}$
 Thus, phase angle 1110° indicates that during its 4th oscillation, the particle is at $+A/2$ and moving to the positive extreme.

Example 5.8: While completing its third oscillation during linear S.H.M., a particle

is at $\frac{-\sqrt{3}}{2} A$, heading to the mean position.

Determine the phase angle.

Solution:

$$A \sin \theta_1 = \frac{-\sqrt{3}}{2} A \therefore \theta_1 = \left(\pi + \frac{\pi}{3}\right)^\circ \text{ or } \left(2\pi - \frac{\pi}{3}\right)^\circ$$

From negative side, the particle is heading to the mean position. Thus, the phase angle is in the fourth quadrant for that oscillation.

$$\therefore \theta_1 = \left(2\pi - \frac{\pi}{3}\right)^\circ$$

As it is the third oscillation, phase

$$\theta = 2 \times 2\pi + \theta_1 \therefore \theta = 4\pi + \left(2\pi - \frac{\pi}{3}\right)$$

$$= 6\pi - \frac{\pi}{3} = \left(\frac{17\pi}{3}\right)^\circ$$

5.9. Graphical Representation of S.H.M.:

(a) Particle executing S.H.M., starting from mean position, towards positive:

As the particle starts from the mean position

Fig (5.6), towards positive, $\phi = 0$

\therefore displacement $x = A \sin \omega t$

Velocity $v = A\omega \cos \omega t$

Acceleration $a = -A\omega^2 \sin \omega t$

(t)	0	T/4	T/2	3T/4	T	5T/4
(θ)	0	$\frac{\pi}{2}$	π	$\frac{3\pi}{2}$	2π	$\frac{5\pi}{2}$
(x)	0	A	0	-A	0	A
(v)	$A\omega$	0	$-A\omega$	0	$A\omega$	0
(a)	0	$-A\omega^2$	0	$A\omega^2$	0	$-A\omega^2$

Conclusions from the graphs:

- Displacement, velocity and acceleration of S.H.M. are periodic functions of time.
- Displacement time curve and acceleration time curves are sine curves and velocity time curve is a cosine curve.
- There is phase difference of $\pi/2$ radian between displacement and velocity.
- There is phase difference of $\pi/2$ radian between velocity and acceleration.

- There is phase difference of π radian between displacement and acceleration.
- Shapes of all the curves get repeated after 2π radian or after a time T .

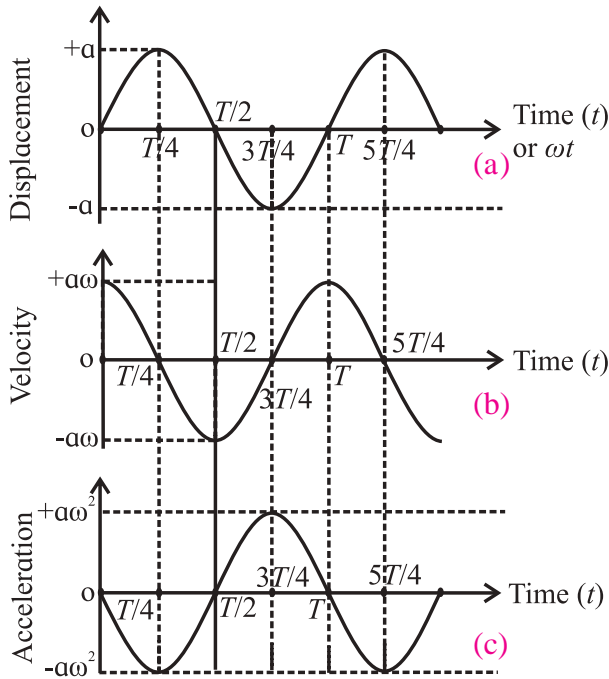

Fig. 5.6: (a) Variation of displacement with time, (b) Variation of velocity with time, (c) Variation of acceleration with time.

(b) Particle performing S.H.M., starting from the positive extreme position.

As the particle starts from the positive extreme position Fig. (5.7), $\phi = \frac{\pi}{2}$

\therefore displacement, $x = A \sin(\omega t + \pi / 2) = A \cos \omega t$

Velocity, $v = \frac{dx}{dt} = \frac{d(A \cos \omega t)}{dt} = -A\omega \sin(\omega t)$

Acceleration,

$a = \frac{dv}{dt} = \frac{d(-A\omega \sin(\omega t))}{dt} = -A\omega^2 \cos(\omega t)$

(t)	0	T/4	T/2	3T/4	T	5T/4
(θ)	$\frac{\pi}{2}$	π	$\frac{3\pi}{2}$	2π	$\frac{5\pi}{2}$	3π
(x)	A	0	-A	0	A	0
(v)	0	-A ω	0	A ω	0	-A ω
(a)	-A ω^2	0	A ω^2	0	-A ω^2	0

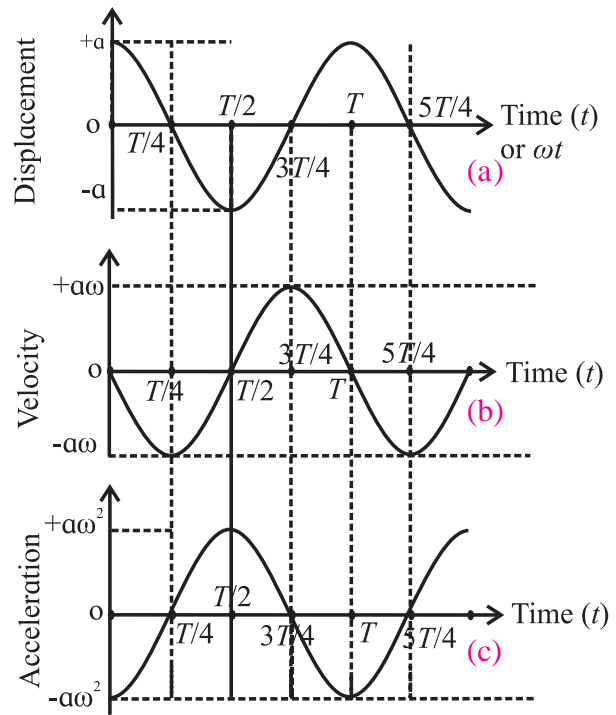

Fig. 5.7: (a) Variation of displacement with time, (b) Variation of velocity with time, (c) Variation of acceleration with time.

5.10 Composition of two S.H.M.s having same period and along the same path:

Consider a particle subjected simultaneously to two S.H.M.s having the same period and along same path (let it be along the x -axis), but of different amplitudes and initial phases. The resultant displacement at any instant is equal to the vector sum of its displacements due to both the S.H.M.s at that instant.

Equations of displacement of the two S.H.M.s along same straight line (x -axis) are

$x_1 = A_1 \sin(\omega t + \phi_1)$ and $x_2 = A_2 \sin(\omega t + \phi_2)$

The resultant displacement (x) at any instant (t) is given by $x = x_1 + x_2$

$x = A_1 \sin(\omega t + \phi_1) + A_2 \sin(\omega t + \phi_2)$

$\therefore x = A_1 \sin \omega t \cos \phi_1 + A_1 \cos \omega t \sin \phi_1 + A_2 \sin \omega t \cos \phi_2 + A_2 \cos \omega t \sin \phi_2$

A_1, A_2, ϕ_1 and ϕ_2 are constants and ωt is variable.

Thus, collecting the constants together,

$x = (A_1 \cos \phi_1 + A_2 \cos \phi_2) \sin \omega t + (A_1 \sin \phi_1 + A_2 \sin \phi_2) \cos \omega t$

As A_1, A_2, ϕ_1 and ϕ_2 are constants, we can combine them in terms of another convenient constants R and δ as

$$R \cos \delta = A_1 \cos \phi_1 + A_2 \cos \phi_2 \quad \text{--- (5.17)}$$

and $R \sin \delta = A_1 \sin \phi_1 + A_2 \sin \phi_2 \quad \text{--- (5.18)}$

$$\therefore x = R (\sin \omega t \cos \delta + \cos \omega t \sin \delta)$$

$$\therefore x = R \sin (\omega t + \delta)$$

This is the equation of an S.H.M. of the same angular frequency (hence, the same period) but of amplitude R and initial phase δ . It shows that the combination (superposition) of two linear S.H.M.s of the same period and occurring along the same path is also an S.H.M.

Resultant amplitude,

$$R = \sqrt{(R \sin \delta)^2 + (R \cos \delta)^2}$$

Substituting from Eq. (5.17) and Eq. (5.18), we get

$$R^2 = A_1^2 + A_2^2 + 2A_1A_2 \cos(\phi_1 - \phi_2)$$

$$\therefore R = \sqrt{A_1^2 + A_2^2 + 2A_1A_2 \cos(\phi_1 - \phi_2)} \quad \text{--- (5.19)}$$

Initial phase (δ) of the resultant motion:

Dividing Eq. (5.18) by Eq. (5.17), we get

$$\frac{R \sin \delta}{R \cos \delta} = \frac{A_1 \sin \phi_1 + A_2 \sin \phi_2}{A_1 \cos \phi_1 + A_2 \cos \phi_2}$$

$$\therefore \tan \delta = \frac{A_1 \sin \phi_1 + A_2 \sin \phi_2}{A_1 \cos \phi_1 + A_2 \cos \phi_2}$$

$$\therefore \delta = \tan^{-1} \left(\frac{A_1 \sin \phi_1 + A_2 \sin \phi_2}{A_1 \cos \phi_1 + A_2 \cos \phi_2} \right) \quad \text{--- (5.20)}$$

Special cases: (i) If the two S.H.M.s are in phase, $(\phi_1 - \phi_2) = 0^\circ$, $\therefore \cos(\phi_1 - \phi_2) = 1$.

$\therefore R = \sqrt{A_1^2 + A_2^2 + 2A_1A_2} = \pm(A_1 + A_2)$. Further, if $A_1 = A_2 = A$, we get $R = 2A$

(ii) If the two S.H.M.s are 90° out of phase, $(\phi_1 - \phi_2) = 90^\circ$ $\therefore \cos(\phi_1 - \phi_2) = 0$.

$\therefore R = \sqrt{A_1^2 + A_2^2}$ Further, if $A_1 = A_2 = A$, we get, $R = \sqrt{2}A$

(iii) If the two S.H.M.s are 180° out of phase, $(\phi_1 - \phi_2) = 180^\circ$ $\therefore \cos(\phi_1 - \phi_2) = -1$

$$\therefore R = \sqrt{A_1^2 + A_2^2 - 2A_1A_2} \therefore R = |A_1 - A_2|$$

Further, if $A_1 = A_2 = A$, we get $R = 0$



Activity

Tie a string horizontally tight between two vertical supports. To this string, tie three pendula, two of them (A and B) of equal lengths. Third one (C) need not have the same length, but not very different. Oscillate the pendula A and B in a plane perpendicular to the horizontal string. It will be observed that pendulum C also starts oscillating in the same plane, with the same period as those of A and B.

With this system and procedure, we are imposing two S.H.M.s of the same period. The resultant energy transfers through the strings into the third pendulum C and it starts oscillating. Special cases (i), (ii) and (iii) above can be verified by making suitable changes.

5.11: Energy of a Particle Performing S.H.M.:

While performing an S.H.M., the particle possesses speed (hence kinetic energy) at all the positions except at the extreme positions. In spite of the presence of a restoring force (except at the mean position), the particle occupies various positions. This is an indication that work is done and the system has potential energy (elastic - in the case of a spring, gravitational - for a pendulum, magnetic - for a magnet, etc.). Total energy of the particle performing an S.H.M. is thus the sum of its kinetic and potential energies.

Consider a particle of mass m , performing a linear S.H.M. along the path MN about the mean position O. At a given instant, let the particle be at P, at a distance x from O.

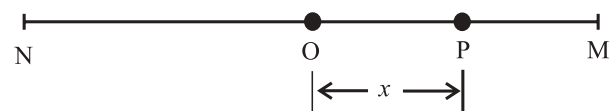

Fig. 5.8: Energy in an S.H.M.

Velocity of the particle in S.H.M. is given as $v = \omega \sqrt{A^2 - x^2} = A\omega \cos(\omega t + \phi)$,

where x is the displacement of the particle performing S.H.M. and A is the amplitude of S.H.M.

Thus, the kinetic energy,

$$E_k = \frac{1}{2} m \omega^2 (A^2 - x^2) = \frac{1}{2} k (A^2 - x^2) \text{--- (5.21)}$$

This is the kinetic energy at displacement x .

At time t , it is

$$\begin{aligned} E_k &= \frac{1}{2} m v^2 = \frac{1}{2} m A^2 \omega^2 \cos^2(\omega t + \phi) \\ &= \frac{1}{2} k A^2 \cos^2(\omega t + \phi) \text{--- (5.22)} \end{aligned}$$

Thus, with time, it varies as $\cos^2 \theta$.

The restoring force acting on the particle at point P is given by $f = -kx$ where k is the force constant. Suppose that the particle is displaced further by an infinitesimal displacement dx against the restoring force f . The external work done (dW) during this displacement is

$$dW = f(-dx) = -kx(-dx) = kx dx$$

The total work done on the particle to displace it from O to P is given by

$$W = \int_0^x dW = \int_0^x kx dx = \frac{1}{2} kx^2$$

This should be the potential energy (P.E.) E_p of the particle at displacement x .

$$\therefore E_p = \frac{1}{2} kx^2 = \frac{1}{2} m \omega^2 x^2 \text{--- (5.23)}$$

At time t , it is

$$\begin{aligned} E_p &= \frac{1}{2} kx^2 = \frac{1}{2} k A^2 \sin^2(\omega t + \phi) \\ &= \frac{1}{2} m A^2 \omega^2 \sin^2(\omega t + \phi) \end{aligned}$$

Thus, with time, it varies as $\sin^2 \theta$.

The total energy of the particle is the sum of its kinetic energy and potential energy.

$$\therefore E = E_k + E_p$$

Using Eq. (5.21) and Eq. (5.23), we get

$$\begin{aligned} E &= \frac{1}{2} m \omega^2 (A^2 - x^2) + \frac{1}{2} m \omega^2 x^2 \\ E &= \frac{1}{2} m \omega^2 A^2 = \frac{1}{2} k A^2 = \frac{1}{2} m (v_{max})^2 \text{--- (5.24)} \end{aligned}$$

This expression gives the total energy of the particle at point P. As m , ω and A are

constant, the total energy of the particle at any point P is constant (independent of x and t). In other words, the energy is conserved in S.H.M. If n is the frequency in S.H.M., $\omega = 2\pi n$. Using this in Eq. (5.24), we get

$$\begin{aligned} E &= \frac{1}{2} m (2\pi n)^2 A^2 = 2\pi^2 n^2 A^2 m \\ &= 2\pi^2 m \frac{A^2}{T^2} \text{--- (5.25)} \end{aligned}$$

Thus, the total energy in S.H.M. is directly proportional to (a) the mass of the particle (b) the square of the amplitude (c) the square of the frequency (d) the force constant, and inversely proportional to square of the period.



Can you tell?

To start a pendulum swinging, usually you pull it slightly to one side and release.

- What kind of energy is transferred to the mass in doing this?
- Describe the energy changes that occur when the mass is released.
- Is/are there any other way/ways to start the oscillations of a pendulum? Which energy is supplied in this case/cases?

Special cases: (i) At the mean position, $x = 0$ and velocity is maximum.

Hence $E = (E_k)_{max} = \frac{1}{2} m \omega^2 A^2$ and potential energy $(E_p)_{min} = 0$

(ii) At the extreme positions, the velocity of the particle is zero and $x = \pm A$

Hence $E = (E_p)_{max} = \frac{1}{2} m \omega^2 A^2$ and kinetic energy $(E_k)_{min} = 0$

As the particle oscillates, the energy changes between kinetic and potential. At the mean position, the energy is entirely kinetic; while at the extreme positions, it is entirely potential. At other positions the energy is partly kinetic and partly potential. However, the total energy is always conserved.

(iii) If $K.E. = P.E.$,

$$\frac{1}{2} m \omega^2 (A^2 - x^2) = \frac{1}{2} m \omega^2 x^2 \therefore x = \frac{\pm A}{\sqrt{2}}$$

Thus at $x = \frac{\pm A}{\sqrt{2}}$, the K.E. = P.E. = $\frac{E}{2}$ for a particle performing linear S.H.M.

(iv) At $x = \frac{\pm A}{2}$, P.E. = $\frac{1}{2}kx^2 = \frac{1}{4}\left(\frac{1}{2}kA^2\right) = \frac{E}{4}$

\therefore K.E. = 3(P.E)

Thus, at $x = \frac{\pm A}{2}$, the energy is 25% potential and 75% kinetic.

The variation of K.E. and P.E. with displacement in S.H.M. is shown in Fig. (5.9)

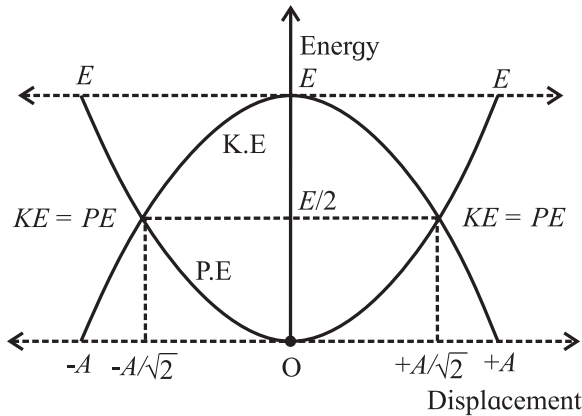

Fig. 5.9: Energy in S.H.M.

Example 5.9: The total energy of a particle of mass 200 g, performing S.H.M. is 10^{-2} J. Find its maximum velocity and period if the amplitude is 7 cm.

Solution:

$$E = \frac{1}{2} m \omega^2 A^2 \therefore E = \frac{1}{2} m (v_{max})^2$$

$$\therefore v_{max} = \sqrt{\frac{2E}{m}}$$

$$\therefore v_{max} = \sqrt{\frac{2 \times 10^{-2}}{0.2}} = 0.3162 \text{ m/s}$$

$$v_{max} = \omega A = \frac{2\pi}{T} A \therefore T = \frac{2\pi A}{v_{max}} = 1.39 \text{ s}$$

5.12 Simple Pendulum:

An ideal simple pendulum is a heavy particle suspended by a massless, inextensible, flexible string from a rigid support.

A practical simple pendulum is a small heavy (dense) sphere (called bob) suspended by a light and inextensible string from a rigid support.

The distance between the point of suspension and centre of gravity of the bob (point of oscillation) is called the length of the pendulum. Let m be the mass of the bob and T' be the tension in the string. The pendulum remains in equilibrium in the position OA, with the centre of gravity of the bob, vertically below the point of suspension O. If now the pendulum is displaced through a small angle θ (called angular amplitude) and released, it begins to oscillate on either side of the mean (equilibrium) position in a single vertical plane. We shall now show that the bob performs S.H.M. about the mean position for small angular amplitude θ .

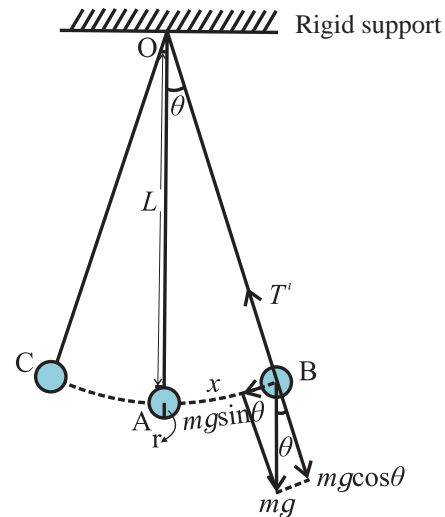

Fig.5.10: Simple pendulum.

In the displaced position (extreme position), two forces are acting on the bob.

- (i) Force T' due to tension in the string, directed along the string, towards the support and
- (ii) Weight mg , in the vertically downward direction.

At the extreme positions, there should not be any net force along the string. The component of mg can only balance the force due to tension. Thus, weight mg is resolved into two components;

- (i) The component $mg \cos \theta$ along the string, which is balanced by the tension T' and
- (ii) The component $mg \sin \theta$ perpendicular to the string is the restoring force acting on mass m tending to return it to the equilibrium position.

\therefore Restoring force, $F = -mg \sin \theta$ --- (5.26)

As θ is very small ($\theta < 10^\circ$), we can write

$\sin \theta \cong \theta^\circ \therefore F \cong -mg\theta$

From the Fig. 5.10, the small angle $\theta = \frac{x}{L}$

$\therefore F = -mg \frac{x}{L}$ --- (5.27)

As m, g and L are constant, $F \propto -x$

Thus, for small displacement, the restoring force is directly proportional to the displacement and is oppositely directed.

Hence the bob of a simple pendulum performs linear S.H.M. for small amplitudes. From Eq. (5.15), the period T of oscillation of a pendulum from can be given as,

$$= \frac{2\pi}{\omega}$$

$$= \frac{2\pi}{\sqrt{\text{acceleration per unit displacement}}}$$

Using Eq. (5.27), $F = -mg \frac{x}{L}$

$\therefore ma = -mg \frac{x}{L}$

$\therefore a = -g \frac{x}{L} \therefore \frac{a}{x} = -\frac{g}{L} = \frac{g}{L}$ (in magnitude)

Substituting in the expression for T , we get,

$T = 2\pi \sqrt{\frac{L}{g}}$ --- (5.28)

The Eq. (5.28) gives the expression for the time period of a simple pendulum. However, while deriving the expression the following assumptions are made.

- (i) The amplitude of oscillations is very small (at least 20 times smaller than the length).
- (ii) The length of the string is large and
- (iii) During the oscillations, the bob moves along a single vertical plane.

Frequency of oscillation n of the simple pendulum is

$n = \frac{1}{T} = \frac{1}{2\pi \sqrt{\frac{L}{g}}}$ --- (5.29)

From the Eq. (5.28), we can conclude the following for a simple pendulum.

- (a) The period of a simple pendulum is directly proportional to the square root of its length.

- (b) The period of a simple pendulum is inversely proportional to the square root of acceleration due to gravity.
- (c) The period of a simple pendulum does not depend on its mass.
- (d) The period of a simple pendulum does not depend on its amplitude (for small amplitude).

These conclusions are also called the 'laws of simple pendulum'.

5.12.1 Second's Pendulum:

A simple pendulum whose period is two seconds is called *second's pendulum*.

Period $T = 2\pi \sqrt{\frac{L}{g}}$

\therefore For a second's pendulum, $2 = 2\pi \sqrt{\frac{L_s}{g}}$

where L_s is the length of second's pendulum, having period $T = 2s$.

$\therefore L_s = \frac{g}{\pi^2}$ --- (5.30)

Using this relation, we can find the length of a second's pendulum at a place, if we know the acceleration due to gravity at that place. Experimentally, if L_s is known, it can be used to determine acceleration due to gravity g at that place.

Example 5.10: The period of oscillations of a simple pendulum increases by 10%, when its length is increased by 21 cm. Find its initial length and initial period.

Solution: $T = 2\pi \sqrt{\frac{l}{g}}$
 $\therefore \frac{100}{110} = \sqrt{\frac{l_1}{l_2}}$

$\therefore \frac{10}{11} = \sqrt{\frac{l_1}{l_1 + 0.21}}$

$\therefore 1.21l_1 = l_1 + 0.21 \therefore l_1 = 1m$

\therefore Period $T = 2\pi \sqrt{\frac{l}{g}} = 2\pi \sqrt{\frac{1}{9.8}}$
 $= 2.006s$



Activity

When you perform the experiment to determine the period of simple pendulum, it is recommended to keep the amplitude very small. But how small should it be? And why?

To find this it would be better to measure the time period for different angular amplitudes.

Let $T_0 = 2\pi\sqrt{\frac{L}{g}}$ be the period for (ideally) very small angular amplitude and T_θ be the period at higher angular amplitude θ . Experimentally determined values of the ratio $\frac{T_\theta}{T_0}$ are as shown in the table below.

θ	20°	45°	50°	70°	90°
$\frac{T_\theta}{T_0}$	1.02	1.04	1.05	1.10	1.18

It shows that the error in the time period is about 2% at amplitude of 20°, 5% at amplitude of 50°, 10% at amplitude of 70° and 18% at amplitude of 90°. Thus, the recommended maximum angular amplitude is less than 20°. It also helps us in restricting the oscillations in a single vertical plane.

Example 5.11: In summer season, a pendulum clock is regulated as a second's pendulum and it keeps correct time. During winter, the length of the pendulum decreases by 1%. How much will the clock gain or lose in one day. ($g = 9.8 \text{ m/s}^2$)

Solution: In summer, with period $T_s = 2 \text{ s}$, the clock keeps correct time. Thus, in a day of 86400 seconds, the clock's pendulum should perform $\frac{86400}{2} = 43200$ oscillations, to keep correct time.

$$L_w = 1\% \text{ less than summer} = 0.99L_s$$

$$T = 2\pi\sqrt{\frac{L}{g}}$$

$$\therefore T \propto \sqrt{L} \therefore \frac{T_w}{T_s} = \sqrt{\frac{L_w}{L_s}} \therefore \frac{T_w}{2} = \sqrt{0.99}$$

$$\therefore T_w = 1.99 \text{ s}$$

With this period, the pendulum will now perform $\frac{86400}{1.99} = 43417$ oscillations per day. Thus, it will gain $43417 - 43200 = 217$ oscillations, per day.

Per oscillations the clock refers to 2 second. Thus, the time gained, per day = $217 \times 2 = 434$ second = 7 minutes, 14 second.

	Conical pendulum	Simple pendulum
1	Trajectory and the plane of the motion of the bob is a horizontal circle	Trajectory and the plane of motion of the bob is part of a vertical circle.
2	K.E. and gravitational P.E. are constant.	K.E. and gravitational P.E. are interconverted and their sum is conserved.
3	Horizontal component of the force due to tension is the necessary centripetal force (governing force).	Tangential component of the weight is the governing force for the energy conversions during the motion.
4	Period, $T = 2\pi\sqrt{\frac{L\cos\theta}{g}}$	Period, $T = 2\pi\sqrt{\frac{L}{g}}$
5	String always makes a fixed angle with the horizontal and can never be horizontal.	With large amplitude, the string can be horizontal at some instances.
6	<i>During the discussion for both, we have ignored the stretching of the string and the energy spent for it. However, the string is always stretched otherwise it will never have tension (except at the extreme positions of the simple pendulum). Also, non-conservative forces like air resistance are neglected.</i>	

5.13: Angular S.H.M. and its Differential Equation:

Figure 5.11 shows a metallic disc attached centrally to a thin wire (preferably nylon or metallic wire) hanging from a rigid support. If the disc is slightly twisted about the axis along the wire, and released, it performs rotational motion partly in clockwise and anticlockwise (or opposite) sense. Such oscillations are called angular oscillations or torsional oscillations.

This motion is governed by the restoring torque in the wire, which is always opposite to the angular displacement. If its magnitude happens to be proportional to the corresponding angular displacement, we can call the motion to be *angular S.H.M.*

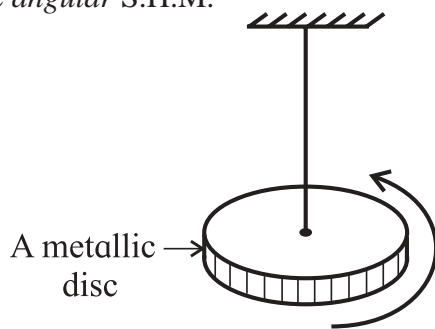

Fig. 5.11: Torsional (angular) oscillations.

Thus, for the angular S.H.M. of a body, the restoring torque acting upon it, for angular displacement θ , is

$$\tau \propto -\theta \text{ or } \tau = -c\theta \quad \text{--- (5.31)}$$

The constant of proportionality c is the restoring torque per unit angular displacement. If I is the moment of inertia of the body, the torque acting on the body is given by, $\tau = I\alpha$ Where α is the angular acceleration. Using this in Eq. (5.31) we get, $I\alpha = -c\theta$

$$\therefore I \frac{d^2\theta}{dt^2} + c\theta = 0 \quad \text{--- (5.32)}$$

This is the differential equation for angular S.H.M. From this equation, the angular acceleration α can be written as,

$$\alpha = \frac{d^2\theta}{dt^2} = -\frac{c\theta}{I}$$

Since c and I are constants, the angular acceleration α is directly proportional to θ and its direction is opposite to that of the angular displacement. Hence, this oscillatory motion is called angular S.H.M.

Angular S.H.M. is defined as the oscillatory motion of a body in which the torque for angular acceleration is directly proportional to the angular displacement and its direction is opposite to that of angular displacement.

The time period T of angular S.H.M. is given by,

$$T = \frac{2\pi}{\omega} = \frac{2\pi}{\sqrt{\text{angular acceleration per unit angular displacement}}}$$

5.13.1 Magnet Vibrating in Uniform Magnetic Field:

If a bar magnet is freely suspended in the plane of a uniform magnetic field, it remains in equilibrium with its axis parallel to the direction of the field. If it is given a small angular displacement θ (about an axis passing through its centre, perpendicular to itself and to the field) and released, it performs angular oscillations Fig. (5.12).

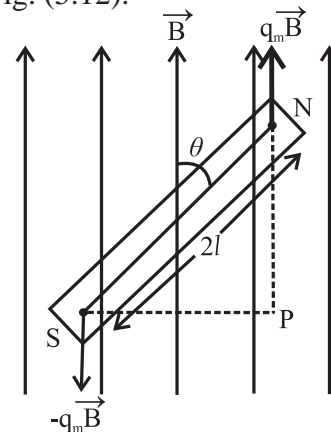

Fig. 5.12: Magnet vibrating in a uniform magnetic field.

Let μ be the magnetic dipole moment and B the magnetic field. In the deflected position, a restoring torque acts on the magnet, that tends to bring it back to its equilibrium position. [Here we used the symbol μ for the magnetic dipole moment as the symbol m is used for mass].

The magnitude of this torque is $\tau = \mu B \sin\theta$

If θ is small, $\sin\theta \cong \theta^\circ \therefore \tau = \mu B\theta$

For clockwise angular displacement θ , the restoring torque is in the anticlockwise direction.

$$\therefore \tau = I\alpha = -\mu B\theta$$

where I is the moment of inertia of the bar magnet and α is its angular acceleration.

$$\therefore \alpha = -\left(\frac{\mu B}{I}\right)\theta \quad \text{--- (5.33)}$$

Since μ , B and I are constants, Eq. (5.33) shows that angular acceleration is directly proportional to the angular displacement and directed opposite to the angular displacement. Hence the magnet performs angular S.H.M.

The period of vibrations of the magnet is given by

$$\begin{aligned} T &= \frac{2\pi}{\sqrt{\frac{\text{angular acceleration per unit}}{\text{angular displacement}}}} \\ &= \frac{2\pi}{\sqrt{\alpha/\theta}} \\ \therefore T &= 2\pi \sqrt{\frac{I}{\mu B}} \quad \text{--- (5.34)} \end{aligned}$$

Example 5.12: A bar magnet of mass 120 g, in the form of a rectangular parallelepiped, has dimensions $l = 40$ mm, $b = 10$ mm and $h = 80$ mm. With the dimension h vertical, the magnet performs angular oscillations in the plane of a magnetic field with period π s. If its magnetic moment is 3.4 A m², determine the influencing magnetic field.

Solution: $T = 2\pi \sqrt{\frac{I}{\mu B}} \quad \therefore \pi = 2\pi \sqrt{\frac{I}{\mu B}}$
 $\therefore B = \frac{4I}{\mu}$

For a bar magnet, moment of inertia

$$\begin{aligned} I &= M \left(\frac{l^2 + b^2}{12} \right) \\ \therefore I &= 0.12 \left(\frac{1600 + 100}{12} \right) \times 10^{-6} \\ &= 1.7 \times 10^{-5} \text{ A m}^2 \\ \therefore B &= \frac{4 \times 1.7 \times 10^{-5}}{3.4} = 2 \times 10^{-5} \text{ Wb m}^{-2} \text{ or T} \end{aligned}$$

Example 5.13: Two magnets with the same dimensions and mass, but of magnetic moments $\mu_1 = 100$ A m² and $\mu_2 = 50$ A m² are jointly suspended in the earth's magnetic field so as to perform angular oscillations in a horizontal plane. When their like poles are joined together, the period of their angular S.H.M. is 5 s. Find the period of angular S.H.M. when their unlike poles are joined together.

Solution:

$$T = 2\pi \sqrt{\frac{I}{\mu B}}$$

With like poles together, the effective magnetic moment is $(\mu_1 + \mu_2)$

$$\therefore T_1 = 2\pi \sqrt{\frac{I}{(\mu_1 + \mu_2) B_H}}$$

With unlike poles together, the effective magnetic moment is $(\mu_1 - \mu_2)$

$$\therefore T_2 = 2\pi \sqrt{\frac{I}{(\mu_1 - \mu_2) B_H}}$$

$$\therefore \frac{T_1}{T_2} = \sqrt{\frac{(\mu_1 - \mu_2)}{(\mu_1 + \mu_2)}}$$

$$\therefore \frac{5}{T_2} = \sqrt{\frac{1}{3}} \quad \therefore T_2 = \sqrt{75} = 8.665 \text{ s}$$

5.14 Damped Oscillations:

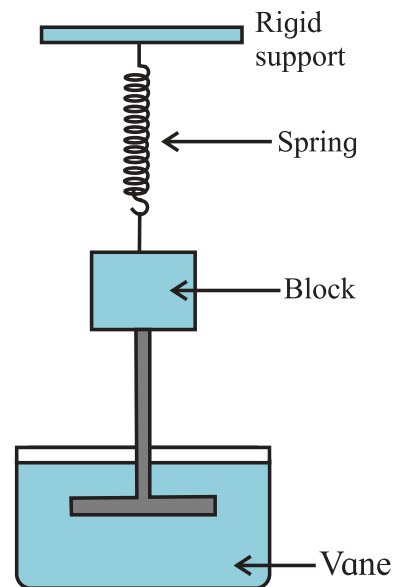

Fig. 5.13: A damped oscillator.

If the amplitude of oscillations of an oscillator is reduced by the application of an external force, the oscillator and its motion are said to be *damped*. *Periodic oscillations of gradually decreasing amplitude are called damped harmonic oscillations and the oscillator is called a damped harmonic oscillator.*

For example, the motion of a simple pendulum, dies eventually as air exerts a viscous force on the pendulum and there may be some friction at the support.

Figure 5.13 shows a block of mass m that can oscillate vertically on a spring. From the block, a rod extends to vane that is submerged on a liquid. As the vane moves up and down, the liquid exerts drag force on it, and thus on the complete oscillating system. The mechanical energy of the block-spring system decreases with time, as energy is transferred to thermal energy of the liquid and vane.

The damping force (F_d) depends on the nature of the surrounding medium and is directly proportional to the speed v of the vane and the block

$$\therefore F_d = -bv$$

Where b is the damping constant and negative sign indicates that F_d opposes the velocity.

For spring constant k , the force on the block from the spring is $F_s = -kx$.

Assuming that the gravitational force on the block is negligible compared to F_d and F_s , the total force acting on the mass at any time t is

$$\begin{aligned} F &= F_d + F_s \\ \therefore ma &= F_d + F_s \\ \therefore ma &= -bv - kx \\ \therefore ma + bv + kx &= 0 \\ \therefore m \frac{d^2x}{dt^2} + b \frac{dx}{dt} + kx &= 0 \quad \text{--- (5.35)} \end{aligned}$$

The solution of Eq. (5.35) describes the motion of the block under the influence of a damping force which is proportional to the speed.

The solution is found to be of the form

$$x = Ae^{-bt/2m} \cos(\omega't + \phi) \quad \text{--- (5.36)}$$

$(Ae^{-bt/2m})$ is the amplitude of the damped harmonic oscillations.

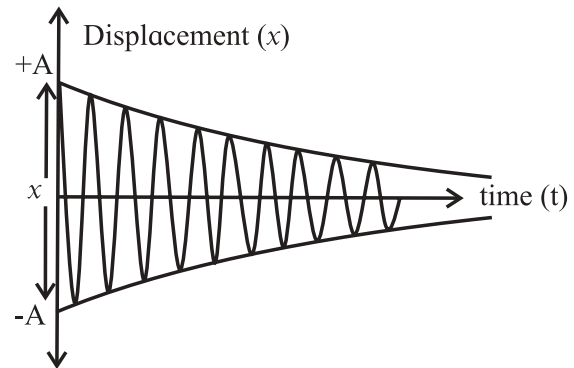

Fig. 5.14: Displacement against time graph.

As shown in the displacement against time graph (Fig 5.14), the amplitude decreases with time exponentially. The term $\cos(\omega't + \phi)$ shows that the motion is still an S.H.M.

The angular frequency, $\omega' = \sqrt{\frac{k}{m} - \left(\frac{b}{2m}\right)^2}$

Period of oscillation, $T = \frac{2\pi}{\omega} = \frac{2\pi}{\sqrt{\frac{k}{m} - \left(\frac{b}{2m}\right)^2}}$

The damping increases the period (slows down the motion) and decreases the amplitude.

5.15 Free Oscillations, Forced Oscillations and Resonance:

Free Oscillations: If an object is allowed to oscillate or vibrate on its own, it does so with its natural frequency (or with one of its natural frequencies). For example, if the bob of a simple pendulum of length l is displaced and released, it will oscillate only with the frequency $n = \frac{1}{2\pi} \sqrt{\frac{g}{l}}$ which is called its natural frequency and the oscillations are free oscillations. However, by applying a periodic force, the same pendulum can be made to oscillate with different frequency. The oscillations then will be forced oscillations and the frequency is driver frequency or forced frequency.

Consider the arrangement shown in the Fig. 5.15. There are four pendula tied to a string. Pendula A and C are of the same length, pendulum B is shorter and pendulum D is longer. Pendulum A is having a solid rubber ball as its bob and will act as the driver pendulum or source pendulum. Other three pendula are having hollow rubber balls as their bobs and will act as the driven pendula. As the pendula A and C are of the same lengths, their natural frequencies are the same. Pendulum B has higher natural frequency as it is shorter and pendulum D is of lower natural frequency than that of A and C.

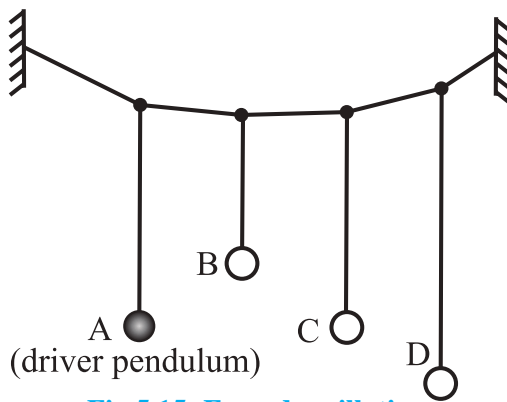

Fig 5.15: Forced oscillations.

Pendulum A is now set into oscillations in a plane perpendicular to the string. In the course of time it will be observed that the other three pendula also start oscillating in parallel planes. This happens due to the transfer of vibrational energy through the string. Oscillations of A are free oscillations and those of B, C and D are *forced oscillations* of the *same* frequency as that of A. The natural frequency of pendulum C is the same as that of A, as it is of the same length as that of A.

It can also be seen that among the pendula B, C and D, the pendulum C oscillates with maximum amplitude and the other two with smaller amplitudes. As the energy depends upon the amplitude, it is clear that Pendulum C has absorbed maximum energy from the source pendulum A, while the other two absorbed less. It shows that the object C having the same natural frequency as that of the source

absorbs maximum energy from the source. In such case, it is said to be in *resonance* with the source (pendulum A). For unequal natural frequencies on either side (higher or lower), the energy absorbed (hence, the amplitude) is less. If the activity is repeated for a set of pendula of different lengths and squares of their amplitudes are plotted against their natural frequencies, the plot will be similar to that shown in the Fig. 5.16. The peak occurs when the forced frequency matches with the natural frequency, i.e., at the resonant frequency.

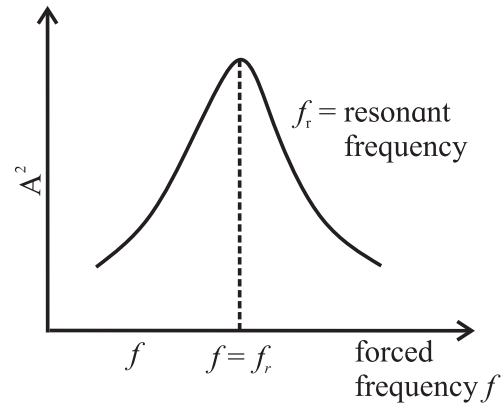

Fig 5.16: Resonant frequency.

In Chapter superposition of waves, you will see that most of the traditional musical instruments use the principle of resonance. In the topic AC circuits, the resonance in the L.C. circuits is discussed.



Internet my friend

1. <https://hyperphysics.phy-astr.gsu.edu/hbase/shm.html>
2. <https://hyperphysics.phy-astr.gsu.edu/hbase/pend.html>
3. <https://en.wikipedia.org/wiki/simpleharmonicmotion>
4. <https://opentextbc.ca/physicstextbook>
5. <https://physics.info>



Exercises

1. Choose the correct option.

- i) A particle performs linear S.H.M. starting from the mean position. Its amplitude is A and time period is T . At the instance when its speed is half the maximum speed, its displacement x is
 (A) $\frac{\sqrt{3}}{2}A$ (B) $\frac{2}{\sqrt{3}}A$
 (C) $A/2$ (D) $\frac{1}{\sqrt{2}}A$
- ii) A body of mass 1 kg is performing linear S.H.M. Its displacement x (cm) at t (second) is given by $x = 6 \sin(100t + \pi/4)$. Maximum kinetic energy of the body is
 (A) 36 J (B) 9 J
 (C) 27 J (D) 18 J
- iii) The length of second's pendulum on the surface of earth is nearly 1 m. Its length on the surface of moon should be [Given: acceleration due to gravity (g) on moon is $1/6$ th of that on the earth's surface]
 (A) $1/6$ m (B) 6 m
 (C) $1/36$ m (D) $\frac{1}{\sqrt{6}}$ m
- iv) Two identical springs of constant k are connected, first in series and then in parallel. A metal block of mass m is suspended from their combination. The ratio of their frequencies of vertical oscillations will be in a ratio
 (A) 1:4 (B) 1:2 (C) 2:1 (D) 4:1
- v) The graph shows variation of displacement of a particle performing S.H.M. with time t . Which of the following statements is correct from the graph?
 (A) The acceleration is maximum at time T .
 (B) The force is maximum at time $3T/4$.
 (C) The velocity is zero at time $T/2$.

(D) The kinetic energy is equal to total energy at time $T/4$.

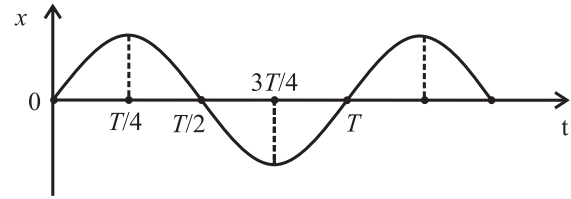

2. Answer in brief.

- i) Define linear simple harmonic motion.
 - ii) Using differential equation of linear S.H.M, obtain the expression for (a) velocity in S.H.M., (b) acceleration in S.H.M.
 - iii) Obtain the expression for the period of a simple pendulum performing S.H.M.
 - iv) State the laws of simple pendulum.
 - v) Prove that under certain conditions a magnet vibrating in uniform magnetic field performs angular S.H.M.
3. Obtain the expression for the period of a magnet vibrating in a uniform magnetic field and performing S.H.M.
 4. Show that a linear S.H.M. is the projection of a U.C.M. along any of its diameter.
 5. Draw graphs of displacement, velocity and acceleration against phase angle, for a particle performing linear S.H.M. from (a) the mean position (b) the positive extreme position. Deduce your conclusions from the graph.
 6. Deduce the expressions for the kinetic energy and potential energy of a particle executing S.H.M. Hence obtain the expression for total energy of a particle performing S.H.M and show that the total energy is conserved. State the factors on which total energy depends.
 7. Deduce the expression for period of simple pendulum. Hence state the factors on which its period depends.
 8. At what distance from the mean position is the speed of a particle performing S.H.M. half its maximum speed. Given path length of S.H.M. = 10 cm.

[Ans: 4.33 cm]

9. In SI units, the differential equation of an S.H.M. is $\frac{d^2x}{dt^2} = -36x$. Find its frequency and period.
[Ans: 0.955 Hz, 1.05 s]
10. A needle of a sewing machine moves along a path of amplitude 4 cm with frequency 5 Hz. Find its acceleration $\left(\frac{1}{30}\right)$ s after it has crossed the mean position.
[Ans: 34.2 m/s²]
11. Potential energy of a particle performing linear S.H.M is $0.1 \pi^2 x^2$ joule. If mass of the particle is 20 g, find the frequency of S.H.M.
[Ans: 1.581 Hz]
12. The total energy of a body of mass 2 kg performing S.H.M. is 40 J. Find its speed while crossing the centre of the path.
[Ans: 6.324 cm/s]
13. A simple pendulum performs S.H.M of period 4 seconds. How much time after crossing the mean position, will the displacement of the bob be one third of its amplitude.
[Ans: 0.2163 s]
14. A simple pendulum of length 100 cm performs S.H.M. Find the restoring force acting on its bob of mass 50 g when the displacement from the mean position is 3 cm.
[Ans: 1.48×10^{-2} N]
15. Find the change in length of a second's pendulum, if the acceleration due to gravity at the place changes from 9.75 m/s^2 to 9.8 m/s^2 .
[Ans: Decreases by 0.0051 m]
16. At what distance from the mean position is the kinetic energy of a particle performing S.H.M. of amplitude 8 cm, three times its potential energy?
[Ans: 4 cm]
17. A particle performing linear S.H.M. of period 2π seconds about the mean position O is observed to have a speed of $b\sqrt{3} \text{ m/s}$, when at a distance b (metre) from O. If the particle is moving away from O at that instant, find the time required by the particle, to travel a further distance b .
[Ans: $\pi/3$ s]
18. The period of oscillation of a body of mass m_1 suspended from a light spring is T . When a body of mass m_2 is tied to the first body and the system is made to oscillate, the period is $2T$. Compare the masses m_1 and m_2 .
[Ans: 1/3]
19. The displacement of an oscillating particle is given by $x = a\sin\omega t + b\cos\omega t$ where a , b and ω are constants. Prove that the particle performs a linear S.H.M. with amplitude $A = \sqrt{a^2 + b^2}$
20. Two parallel S.H.M.s represented by $x_1 = 5\sin(4\pi t + \pi/3)$ cm and $x_2 = 3\sin(4\pi t + \pi/4)$ cm are superposed on a particle. Determine the amplitude and epoch of the resultant S.H.M.
[Ans: 7.936 cm, $54^\circ 23'$]
21. A 20 cm wide thin circular disc of mass 200 g is suspended to a rigid support from a thin metallic string. By holding the rim of the disc, the string is twisted through 60° and released. It now performs angular oscillations of period 1 second. Calculate the maximum restoring torque generated in the string under undamped conditions. ($\pi^3 \approx 31$)
[Ans: 0.04133 N m]
22. Find the number of oscillations performed per minute by a magnet is vibrating in the plane of a uniform field of $1.6 \times 10^{-5} \text{ Wb/m}^2$. The magnet has moment of inertia $3 \times 10^{-6} \text{ kg/m}^2$ and magnetic moment 3 A m^2 .
[Ans: 38.19 osc/min.]
23. A wooden block of mass m is kept on a piston that can perform vertical vibrations of adjustable frequency and amplitude. During vibrations, we don't want the block to leave the contact with the piston. How much maximum frequency is possible if the amplitude of vibrations is restricted to 25 cm? In this case, how much is the energy per unit mass of the block? ($g \approx \pi^2 \approx 10 \text{ m s}^{-2}$)
[Ans: $n_{\text{max}} = 1/s$, $E/m = 1.25 \text{ J/kg}$]

6. Superposition of Waves



Can you recall?

1. What is wave motion?
2. What is a wave pulse?
3. What are common properties of waves?
4. What happens when a wave propagates?
5. What are mechanical waves?
6. What are electromagnetic waves?
7. How are mechanical waves different from electromagnetic waves?
8. What are sound waves?

6.1 Introduction:

You may be familiar with different waves like water waves, sound waves, light waves, mechanical waves, electromagnetic waves etc. A mechanical wave is a disturbance produced in an elastic medium due to periodic vibrations of particles of the medium about their respective mean positions. In this process, energy and momentum are transferred from one particle to another. Thus, a wave carries or transfers energy from one point to another., but there is no transfer of matter or particles of the medium in which the wave is travelling. Another type of waves, known as electromagnetic waves, do not require material medium for their propagation; these are non-mechanical waves. We have studied sound waves (which are mechanical waves), their properties and various phenomena like echo, reverberation, Doppler effect related to these waves in earlier classes. In this Chapter, we will study mechanical waves, reflection of these waves, principle of superposition of waves, various phenomena like formation of stationary waves, beats, and their applications.

6.2 Progressive Wave:

Have you seen ripples created on the surface of water when a stone is dropped in it?

The water is displaced locally where the stone actually falls in water. The disturbance slowly spreads and distant particles get disturbed from their position of rest. The wave disturbs the particles for a short duration during its path. These particles oscillate about their position of rest for a short time. They are not bodily moved from their respective positions. This disturbance caused by the stone is actually a wave pulse. It is a disturbance caused locally for a short duration.

A wave, in which the disturbance produced in the medium travels in a given direction continuously, without any damping and obstruction, from one particle to another, is a progressive wave or a travelling wave e.g., the sound wave, which is a pressure wave consisting of compressions and rarefactions travelling along the direction of propagation of the wave.

6.2.1 Properties of progressive waves:

- 1) Each particle in a medium executes the same type of vibration. Particles vibrate about their mean positions performing simple harmonic motion.
- 2) All vibrating particles of the medium have the same amplitude, period and frequency.
- 3) The phase, (i.e., state of vibration of a particle), changes from one particle to another.
- 4) No particle remains permanently at rest. Each particle comes to rest momentarily while at the extreme positions of vibration.
- 5) The particles attain maximum velocity when they pass through their mean positions.
- 6) During the propagation of wave, energy is transferred along the wave. There is no transfer of matter.
- 7) The wave propagates through the medium

with a certain velocity. This velocity depends upon properties of the medium.

- 8) Progressive waves are of two types - transverse waves and longitudinal waves.
- 9) In a transverse wave, vibrations of particles are perpendicular to the direction of propagation of wave and produce crests and troughs in their medium of travel. In longitudinal wave, vibrations of particles produce compressions and rarefactions along the direction of propagation of the wave.
- 10) Both, the transverse as well as the longitudinal, mechanical waves can propagate through solids but only longitudinal waves can propagate through fluids.

You might recall that when a mechanical wave passes through an elastic medium, the displacement of any particle of the medium at a space point x at time t is given by the expression

$$y(x, t) = f(x - vt) \quad \text{--- (6.1)}$$

where v is the speed at which the disturbance travels through the medium to the right (increasing x). The factor $(x - vt)$ appears because the disturbance produced at the point $x = 0$ at time t reaches the point $x = x'$ on the right at time $(t + x'/v)$ or we say that the disturbance of the particle at time t at position $x = x'$ actually originated on the left side at time $(t - x'/v)$. Thus Eq. (6.1) represents a progressive wave travelling in the positive x -direction with a constant speed v . The function f depends on the motion of the source of disturbance. If the source of disturbance is performing simple harmonic motion, the wave is represented as a sine or cosine function of $(x - vt)$ multiplied by a term which will make $(x - vt)$ dimensionless. Generally we represent such a wave by the following equation

$$y(x, t) = A \sin(kx - \omega t) \quad \text{--- (6.2)}$$

where A is the amplitude of the wave, $k = 2\pi/\lambda$ is the wave number, λ and ω are the wavelength and the angular frequency of the wave and $v = \omega/k$ is the speed. The SI units of k , λ and ω

are rad m^{-1} , m and rad s^{-1} respectively. If T is the time period of oscillation, then $n = 1/T = \omega/(2\pi)$ is the frequency of oscillation measured in $\text{Hz (s}^{-1}\text{)}$. If the wave is travelling to the left *i.e.*, along the negative x -direction, then the equation for the disturbance is

$$y(x, t) = A \sin(kx + \omega t) \quad \text{--- (6.3)}$$



Can you tell?

What is the minimum distance between any two particles of a medium which always have the same speed if a sine wave travels through the medium?

6.3 Reflection of Waves:

When a progressive wave, travelling through a medium, reaches an interface separating two media, a certain part of the wave energy comes back in the same medium. The wave changes its direction of travel. This is called reflection of a wave from the interface.

Reflection is the phenomenon in which the sound wave traveling from one medium to another comes back in the original medium with slightly different intensity and energy. To understand the reflection of waves, we will consider three examples below.

6.3.1 Reflection of a Transverse Wave:

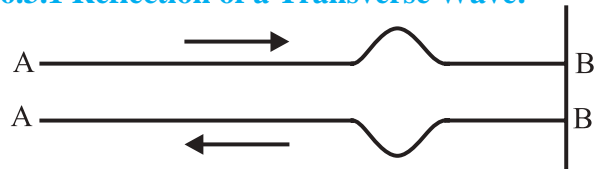

Fig. 6.1: Reflection of a wave pulse sent as a crest from a rarer medium to a denser medium.

Example 1

- Take a long light string AB. Attach one end of the string to a rigid support at B. (Here, for the wave pulse traveling on the string, the string is the rarer medium and the rigid support acts as a denser medium.)
- By giving a jerk to the free end A of the string, a crest is generated in the string.
- Observe what happens when this crest moves towards B?
- Observe what happens when the crest reaches B?

- Perform the same activity repeatedly and observe carefully. Try to find the reasons of movements in above observations.

Example 2

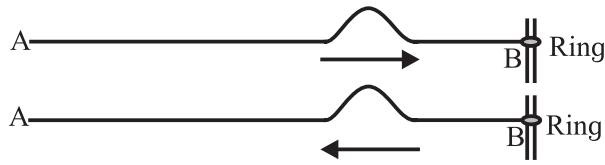

Fig.6.2: Reflection of a wave pulse sent as a crest from a denser medium to a rarer medium.

- Take a long light string AB. Attach the end B of the string to a ring which can slide easily on a vertical metal rod without friction. (Here string is the denser medium while end B attached to the sliding ring is at the interface of a rarer medium as it can move freely.)
- Give a jerk to free end A of the string.
- Observe what happens when crest reaches the point B attached to the ring.
- Try to find the reason of the observed movement.

Example 3

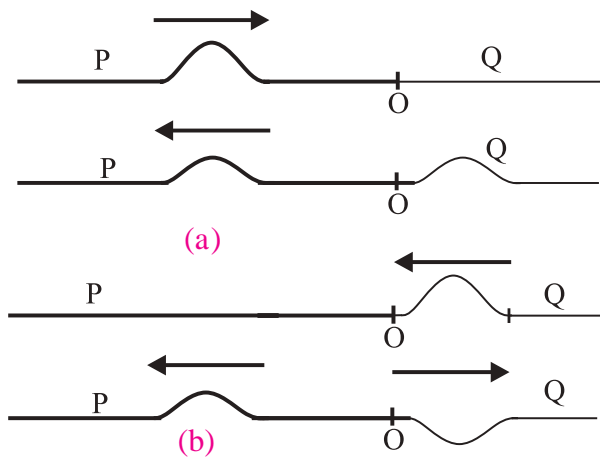

Fig. 6.3: Reflection of a crest from (a) denser medium (in this case a heavy string) and (b) rarer medium (in this case a light string).

- Take a heavy string P and a light string Q and join them. Suppose they are joined at point O. (Heavy string acts as a denser medium and light string is the rarer medium.)
- Produce a wave pulse as a crest on the heavy string P moving towards the junction O.

- Observe the part of wave pulse reflected back on the heavy string.
- Produce a wave pulse as a crest on the light string Q moving towards the junction point O.
- Observe the part of wave pulse reflected on the light string.
- What difference do you observe when the wave pulse gets reflected on the light string and when the wave pulse gets reflected on the heavy string?
- Try to find reasons behind your observations.

In example 1, when crest moves along the string towards B, it pulls the particles of string in upward direction. Similarly when the crest reaches B at rigid support, it tries to pull the point B upwards. But being a rigid support, B remains at rest and an equal and opposite reaction is produced on the string according to Newton's third law of motion. The string is pulled downwards. Thus crest gets reflected as a trough (Fig. 6.1) or a trough gets reflected as a crest. Hence from example 1, we can conclude that when transverse wave is reflected from a rigid support, i.e., from a denser medium, a crest is reflected as a trough and a trough is reflected as a crest. You have learnt in Xth and XIth Std. that there is a phase difference of π radian between the particles at a crest and at a trough. Therefore we conclude that there is a phase change of π radian on reflection from the fixed end, i.e., from a denser medium.

In example 2, we observe that when the crest reaches the point B, it pulls the ring upwards and causes the ring to move upward. The wave is seen to get reflected back as a crest and no phase change occurs on reflection from a rarer medium (Fig. 6.2).

In example 3, we find that a crest travelling from the heavy string gets reflected as a crest from the lighter string, i.e., reflection at the surface when a wave is travelling from a denser medium to a rarer medium causes a crest to be reflected as a crest (Fig. 6.3 (a)).

But in example 3 (Fig. 6.3 (b)), when a crest travels from the lighter string to the heavy string, the crest is reflected as a trough and vice versa.

6.3.2 Reflection of a Longitudinal Wave:

Consider a longitudinal wave travelling from a rarer medium to a denser medium. In a longitudinal wave compression is a high pressure region while rarefaction is a low pressure region. When compression reaches the denser medium, it tries to push the particles of that medium. But the energy of particles in the rarer medium is not sufficient to compress the particles of denser medium. According to Newton's third law of motion, an equal and opposite reaction comes into play. As a result, the particles of rarer medium get compressed. Thus, when the longitudinal wave travels from a rarer medium to a denser medium, a compression is reflected as a compression and a rarefaction is reflected as a rarefaction. There is no change of phase during this reflection (Fig. 6.4).

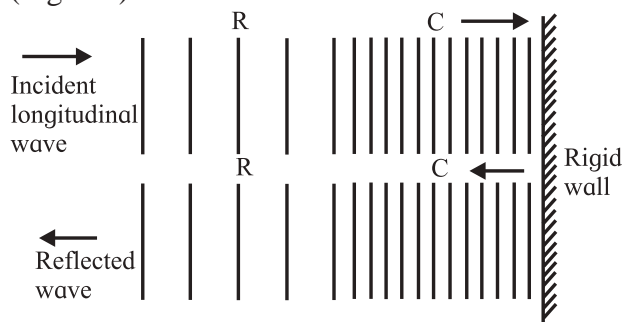

Fig. 6.4: Reflection of a longitudinal wave from a denser medium.

When longitudinal wave travels from a denser medium to a rarer medium (Fig. 6.5), a compression is reflected as a rarefaction. Here reversal of phase takes place, i.e., phase changes by π radians.

When compression reaches a rarer medium from denser medium, it pushes the particles of rare medium. Due to this, particles of the rarer medium get compressed and move forward and a rarefaction is left behind. Thus a compression gets reflected as a rarefaction. Similarly a rarefaction gets reflected as a compression (Fig. 6.5).

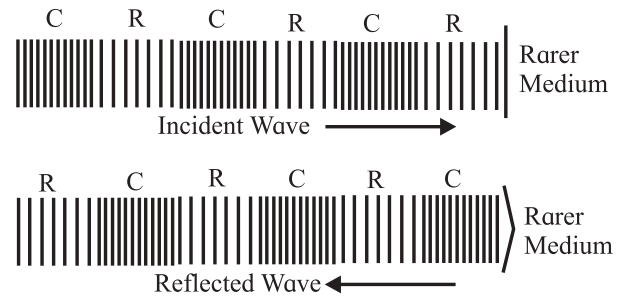

Fig. 6.5: Reflection of a longitudinal wave from a rarer medium.

6.4 Superposition of Waves:

Suppose you wish to listen to your favourite music. Is it always possible particularly when there are many other sounds from the surroundings disturbing you. How can the background sounds be blocked? Of course, the mobile lover generation uses headphones and enjoys listening to its favorite music. But you cannot avoid the background sound completely. Why?

We know that sound waves are longitudinal waves propagating through an elastic medium. When two waves travelling through a medium cross each other, each wave travels in such a way as if there is no other wave. Each wave sets the particles of the medium into simple harmonic motion. Thus each particle of the medium is set into two simple harmonic motions due to the two waves. The total displacement of the particles, at any instant of time during travelling of these waves, is the vector sum of the two displacements. This happens according to the principle of superposition of waves, which states that, **when two or more waves, travelling through a medium, pass through a common point, each wave produces its own displacement at that point, independent of the presence of the other wave. The resultant displacement at that point is equal to the vector sum of the displacements due to the individual wave at that point.** As displacement is a vector, we must add the individual displacements by considering their directions. There is no change in the shape and nature of individual waves due to superposition of waves. This principle applies to all types of waves like sound waves, light

waves, waves on a string etc. and we say that interference of waves has taken place.

You might have seen singers using a special type of headphones during recording of songs. Those are active noise cancellation headphones, which is the best possible solution to avoid background sound. Active noise cancellation headphones consist of small microphones one on each earpiece. They detect the ambient noise that arrives at the ears. A special electronic circuit is built inside the earpiece to create sound waveforms exactly opposite to the arriving noise. This is called antisound. The antisound is added in the earphones so as to cancel the noise from outside. This is possible due to superposition of waves, as the displacements due to these two waves cancel each other. The phenomena of interference, beats, formation of stationary waves etc. are based on the principle of superposition of waves.

Let us consider superposition of two wave pulses in two different ways.

6.4.1 Superposition of Two Wave Pulses of Equal Amplitude and Same Phase Moving towards Each Other :

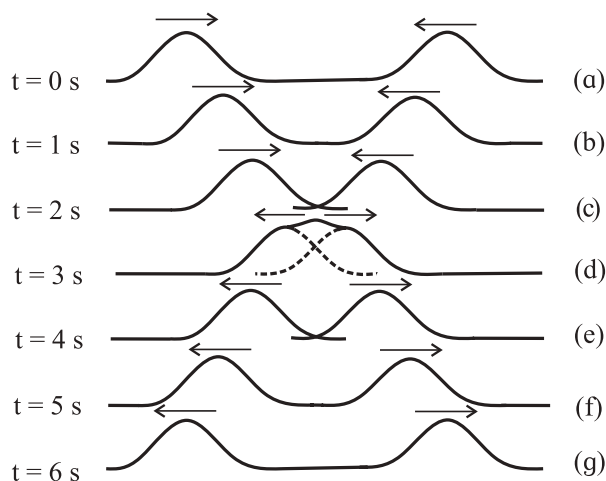

Fig. 6.6: Superposition of two wave pulses of equal amplitude and same phase moving towards each other.

The propagation of approaching wave pulses, their successive positions after every second, their superposition and their

propagation after superposition are shown in Figs. 6.6 (a) to 6.6 (f). Suppose two waves cross each other between $t = 2$ s and $t = 4$ s, as shown in Figs. 6.6 (c), (d) and (e). Here the two wave pulses superpose, the resultant displacement is equal to the sum of the displacements (full line) due to individual wave pulses (dashed lines). This is constructive interference. The displacement due to wave pulses after crossing at $t = 5$ s and $t = 6$ s are shown in Figs. 6.6 (f) and (g). After crossing each other, both the wave pulses continue to maintain their individual shapes.

6.4.2 Superposition of Two Wave Pulses of Equal Amplitude and Opposite Phases Moving towards Each Other :

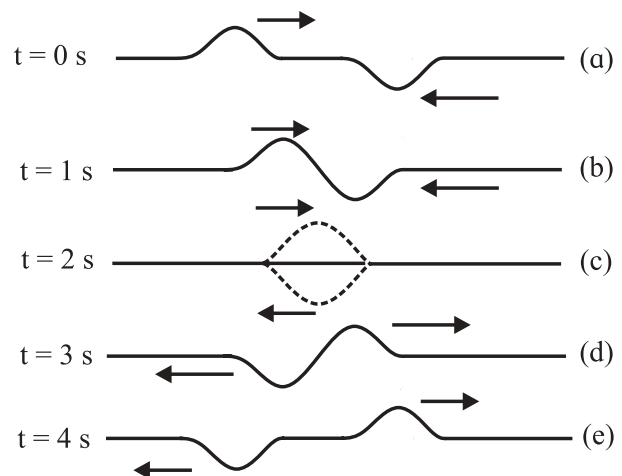

Fig. 6.7: Superposition of two wave pulses of equal amplitude and opposite phases moving towards each other.

The propagation of approaching wave pulses, their successive positions after every second, their superposition and propagation after superposition are shown in Fig. 6.7 (a) to Fig. 6.7 (e).

These wave pulses superimpose at $t = 2$ s and the resultant displacement (full line) is zero, due to individual displacements (dashed lines) differing in phase exactly by 180° . This is destructive interference. Displacement due to one wave pulse is cancelled by the displacement due to the other wave pulse when they cross each other (Fig. 6.7 (c)). After crossing each other, both

the wave pulses continue and maintain their individual shapes.

6.4.3 Amplitude of the Resultant Wave Produced due to Superposition of Two Waves:

Consider two waves having the same frequency but different amplitudes A_1 and A_2 . Let these waves differ in phase by φ . The displacement of each wave at $x = 0$ is given as

$$y_1 = A_1 \sin \omega t$$

$$y_2 = A_2 \sin(\omega t + \varphi)$$

According to the principle of superposition of waves, the resultant displacement at $x = 0$ is

$$y = y_1 + y_2$$

$$\text{or, } y = A_1 \sin \omega t + A_2 \sin(\omega t + \varphi)$$

$$y = A_1 \sin \omega t + A_2 \sin \omega t \cos \varphi + A_2 \cos \omega t \sin \varphi$$

$$y = (A_1 + A_2 \cos \varphi) \sin \omega t + A_2 \sin \varphi \cos \omega t$$

If we write

$$A_1 + A_2 \cos \varphi = A \cos \theta \quad \text{--- (6.4)}$$

$$\text{and } A_2 \sin \varphi = A \sin \theta \quad \text{--- (6.5)}$$

we get

$$y = A \cos \theta \sin \omega t + A \sin \theta \cos \omega t$$

$$\therefore y = A \sin(\omega t + \theta) \quad \text{--- (6.6)}$$

This is the equation of the resultant wave. It has the same frequency as that of the interfering waves. The resultant amplitude A is given by squaring and adding Eqs. (6.4) and (6.5).

$$A^2 \cos^2 \theta + A^2 \sin^2 \theta = (A_1 + A_2 \cos \varphi)^2 + A_2^2 \sin^2 \varphi$$

$$A^2 = A_1^2 + 2 A_1 A_2 \cos \varphi + A_2^2 \cos^2 \varphi + A_2^2 \sin^2 \varphi$$

$$\therefore A = \sqrt{A_1^2 + 2 A_1 A_2 \cos \varphi + A_2^2} \quad \text{--- (6.7)}$$

Special cases:

1. When $\varphi = 0$, i.e., the waves are in phase, the resultant amplitude is

$$A = \sqrt{A_1^2 + 2 A_1 A_2 \cos 0 + A_2^2} = \sqrt{(A_1 + A_2)^2} \\ = A_1 + A_2$$

The resultant amplitude is maximum when $\varphi = 0$.

If the amplitudes of the waves are equal i.e., $A_1 = A_2 = A$ (say), then the resultant amplitude is $2A$.

2. When $\varphi = \pi$, i.e., the waves are out of

phase, the resultant amplitude is

$$A = \sqrt{A_1^2 + 2 A_1 A_2 \cos \pi + A_2^2} = \sqrt{(A_1 - A_2)^2} \\ = |A_1 - A_2|$$

The resultant amplitude is minimum when $\varphi = \pi$.

If the amplitudes of the waves are equal i.e., $A_1 = A_2 = A$ (say), then the resultant amplitude is zero.

Thus, the maximum amplitude is the sum of the two amplitudes when the phase difference between the two waves is zero and the minimum amplitude is the difference of the two amplitudes when the phase difference between the two waves is π .

The intensities of the waves are proportional to the squares of their amplitudes. Hence, when $\varphi = 0$

$$I_{\max} \propto (A_{\max})^2 = (A_1 + A_2)^2 \quad \text{--- (6.8)}$$

and when $\varphi = \pi$

$$I_{\min} \propto (A_{\min})^2 = (A_1 - A_2)^2 \quad \text{--- (6.9)}$$

Therefore intensity is maximum when the two waves interfere in phase while intensity is minimum when the two waves interfere out of phase.

You will learn more about superposition of waves in Chapter 7 on Wave Optics.

Example 6.1: The displacements of two sinusoidal waves propagating through a string are given by the following equations

$$y_1 = 4 \sin(20x - 30t)$$

$$y_2 = 4 \sin(25x - 40t)$$

where x and y are in centimeter and t is in second.

a) Calculate the phase difference between these two waves at the points $x = 5$ cm and $t = 2$ s.

b) When these two waves interfere, what are the maximum and minimum values of the intensity?

Solution: Given

$$y_1 = 4 \sin(20x - 30t)$$

$$\text{and } y_2 = 4 \sin(25x - 40t)$$

a) To find phase difference when $x = 5$ cm and $t = 2$ s:

$$y_1 = 4 \sin(20 \times 5 - 30 \times 2) \\ = 4 \sin(100 - 60) = 4 \sin 40$$

$$y_2 = 4 \sin(25 \times 5 - 40 \times 2) \\ = 4 \sin(125 - 80) = 4 \sin 45$$

\therefore Phase difference is 5 radian because $\phi = |45 - 40| = 5$ radian.

b) To find the maximum and minimum values of the intensity :

Amplitudes of the two waves are $A_1 = 4$ cm and $A_2 = 4$ cm,

$$\therefore I_{max} = (A_1 + A_2)^2 = (4 + 4)^2 = 64$$

when the phase difference is zero

$$\text{and } I_{min} = (A_1 - A_2)^2 = (4 - 4)^2 = 0$$

when the phase difference is π .

Example 6.2: A progressive wave travels on a stretched string. A particle on this string takes 4.0 ms to move from its mean position to one of its extreme positions. The distance between two consecutive points on the string which are at their mean positions (at a certain time instant) is 2.0 cm. Find the frequency, wavelength and speed of the wave.

Solution :

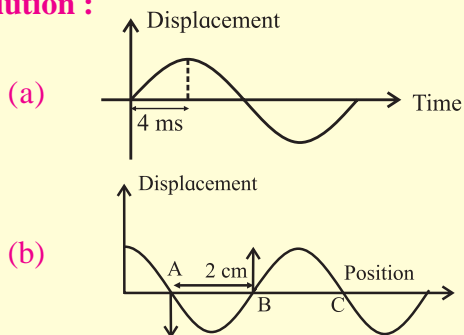

A particle takes 4.0×10^{-3} s to travel from its mean position to extreme position. This is a quarter of the complete oscillation as shown in Fig. (a). Hence, the particle will take $4 \times 4.0 \times 10^{-3}$ s = 16×10^{-3} s to complete one oscillation.

$$\therefore \text{ frequency } n = 1/T = (1/16) \times 10^3 \text{ s}^{-1} \\ = 62.5 \text{ Hz}$$

As shown in Fig. (b), points A, B, and C correspond to mean positions, but the string is moving in one direction at point A and in the opposite direction at point B. Thus, out of the two consecutive particles at their mean positions, one will be moving upwards while the other will be moving downwards. The distance between them is 2.0 cm. Therefore distance between two consecutive particles moving in the same direction will be 2×2 cm = 4 cm. Thus the wavelength $\lambda = 4$ cm = 0.04 m

$$\text{Speed of wave } v = n \times \lambda = 62.5 \times 0.04 \\ = 2.5 \text{ m/s.}$$

6.5 Stationary Waves:

We have seen the superposition of two wave pulses, having same amplitudes and either same phase or opposite phases, and changes in the resultant amplitude pictorially in section 6.4. We have also derived the mathematical expression for the resultant displacement when two waves of same frequency superimpose as given by Eqs. (6.4) to (6.6). Now we are going to study an example of superposition of waves having the same amplitude and the same frequency travelling in opposite directions.

6.5.1 Formation of Stationary Waves:

Imagine a string stretched between two fixed points. If the string is pulled at the middle and released, we get what is known as a stationary wave. Releasing of string produces two progressive waves travelling in opposite directions. These waves are reflected at the fixed ends. The waves produced in the string initially and their reflected waves combine to produce stationary waves as shown in Fig. 6.8 (a).

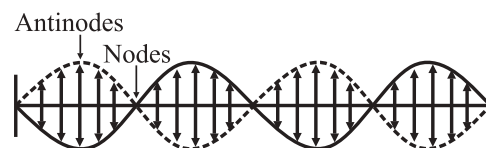

Fig. 6.8 (a): Formation of stationary waves on a string. The two sides arrows indicate the motion of the particles of the string.

6.5.2 Equation of Stationary Wave on a Stretched String:

Consider two simple harmonic progressive waves of equal amplitudes (a) and wavelength (λ) propagating on a long uniform string in opposite directions (remember $2\pi/\lambda = k$ and $2\pi n = \omega$).

The equation of wave travelling along the x -axis in the positive direction is

$$y_1 = a \sin \left\{ 2\pi \left(nt - \frac{x}{\lambda} \right) \right\} \quad \text{--- (6.10)}$$

The equation of wave travelling along the x -axis in the negative direction is

$$y_2 = a \sin \left\{ 2\pi \left(nt + \frac{x}{\lambda} \right) \right\} \quad \text{--- (6.11)}$$

When these waves interfere, the resultant displacement of particles of string is given by the principle of superposition of waves as

$$y = y_1 + y_2$$

$$y = a \sin \left\{ 2\pi \left(nt - \frac{x}{\lambda} \right) \right\} + a \sin \left\{ 2\pi \left(nt + \frac{x}{\lambda} \right) \right\}$$

By using,

$$\sin C + \sin D = 2 \sin \left(\frac{C+D}{2} \right) \cos \left(\frac{C-D}{2} \right), \text{ we get}$$

$$y = 2a \sin(2\pi nt) \cos \frac{2\pi x}{\lambda}$$

$$y = 2a \cos \frac{2\pi x}{\lambda} \sin(2\pi nt) \quad \text{or, --- (6.12)}$$

Using $2a \cos \frac{2\pi x}{\lambda} = A$ in Eq. (6.12), we get

$$y = A \sin(2\pi nt)$$

As $\omega = 2\pi n$, we get, $y = A \sin \omega t$.

This is the equation of a stationary wave which gives resultant displacement due to two simple harmonic progressive waves. It may be noted that the terms in position x and time t appear separately and not as a combination $2\pi (nt \pm x/\lambda)$.

Hence, the wave is not a progressive wave. x is present only in the expression for the amplitude. The amplitude of the resultant wave is given as $A = 2a \cos \frac{2\pi x}{\lambda}$. It is a periodic function of x i.e., the amplitude is varying periodically in space. The amplitudes are different for different particles but each

point on the string oscillates with the same frequency ω (same as that of the individual progressive wave). All the particles of the string pass through their mean positions simultaneously twice during each vibration. The string as a whole is vibrating with frequency ω with different amplitudes at different points. The wave is not moving either to the left or to the right. We therefore call such a wave a **stationary wave or a standing wave**. Particles move so fast that the visual effect is formation of loops. It is therefore customary to represent stationary waves as loops. In case of a string tied at both the ends, loops are seen when a stationary wave is formed because each progressive wave on a string is a traverse wave. *When two identical waves travelling along the same path in opposite directions interfere with each other, resultant wave is called stationary wave.*

Condition for node:

Nodes are the points of minimum displacement. This is possible if the amplitude is minimum (zero), i.e.,

$$2a \cos \frac{2\pi x}{\lambda} = 0,$$

$$\text{or, } \cos \frac{2\pi x}{\lambda} = 0,$$

$$\text{or, } \frac{2\pi x}{\lambda} = \frac{\pi}{2}, \frac{3\pi}{2}, \frac{5\pi}{2}, \dots$$

$$\therefore x = \frac{\lambda}{4}, \frac{3\lambda}{4}, \frac{5\lambda}{4}, \dots$$

$$\text{i.e., } x = (2p-1) \frac{\lambda}{4} \text{ where } p = 1, 2, 3, \dots$$

The distance between two successive nodes is $\frac{\lambda}{2}$.

Condition for antinode:

Antinodes are the points of maximum displacement,

$$\text{i.e., } A = \pm 2a$$

$$\therefore 2a \cos \frac{2\pi x}{\lambda} = \pm 2a$$

$$\text{or, } \cos \frac{2\pi x}{\lambda} = \pm 1$$

$$\therefore \frac{2\pi x}{\lambda} = 0, \pi, 2\pi, 3\pi \dots$$

$$\text{or, } x = 0, \frac{\lambda}{2}, \lambda, \frac{3\lambda}{2}, \dots$$

$$\text{i.e., } x = \frac{\lambda p}{2} \text{ where } p = 0, 1, 2, 3, \dots$$

The distance between two successive antinodes is $\frac{\lambda}{2}$. Nodes and antinodes are formed alternately. Therefore, the distance between a node and an adjacent antinode is $\frac{\lambda}{4}$.

When $\sin \omega t = 1$, at that instant of time, all the particles for which $\cos kx$ is positive have their maximum displacement in positive direction. At the same instant, all the particles for which $\cos kx$ is negative have their maximum displacement in negative direction. When $\sin \omega t = 0$, all the particles cross their mean positions, some of them moving in the positive direction and some in the negative direction.

Longitudinal waves e.g. sound waves travelling in a tube /pipe of finite length are reflected at the ends in the same way as transverse waves along a string are reflected at the ends. Interference between these waves travelling in opposite directions gives rise to standing waves as shown in Fig. 6.8 (b). We represent longitudinal stationary wave by a loop but the actual motion of the particles is along the length of the loop and not perpendicular to it.

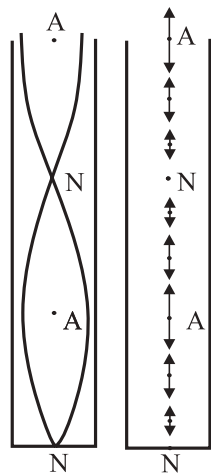

Fig. 6.8 (b): Figure on the left shows standing waves in a conventional way while figure on the right shows the actual oscillations of material particles for a longitudinal stationary wave. Points A and N denote antinodes and nodes respectively.

6.5.3 Properties of Stationary Waves:

1. Stationary waves are produced due to superposition of two identical waves (either transverse or longitudinal waves) traveling

through a medium along the same path in opposite directions.

- If two identical transverse progressive waves superimpose or interfere, the resultant wave is a transverse stationary wave as shown in Fig. 6.8 (a).
 - When a transverse stationary wave is produced on a string, some points on the string are motionless. The points which do not move are called **nodes**.
 - There are some points on the string which oscillate with greatest amplitude (say A). They are called **antinodes**.
 - Points between the nodes and antinodes vibrate with values of amplitudes between 0 and A .
- If two identical longitudinal progressive waves superimpose or interfere, the resultant wave is a longitudinal stationary wave. Figure 6.8 (b) shows a stationary sound wave produced in a pipe closed at one end.
 - The points, at which the amplitude of the particles of the medium is minimum (zero), are called nodes.
 - The points, at which the amplitude of the particles of the medium is maximum (say A), are called antinodes.
 - Points between the nodes and antinodes vibrate with values of amplitudes between 0 and A .
- The distance between two consecutive nodes is $\frac{\lambda}{2}$ and the distance between two consecutive antinodes is $\frac{\lambda}{2}$.
- Nodes and antinodes are produced alternately. The distance between a node and an adjacent antinode is $\frac{\lambda}{4}$.
- The amplitude of vibration varies periodically in space. All points vibrate with the same frequency.
- Though all the particles (except those at the nodes) possess energy, there is no propagation of energy. The wave is localized and its velocity is zero. Therefore, we call it a stationary wave.

8. All the particles between adjacent nodes (i.e., in one loop) vibrate in phase. There is no progressive change of phase from one particle to another particle. All the particles in the same loop are in the same phase of oscillation, which reverses for the adjacent loop.

Musical instruments such as violin, *tanpura*, are based on the principle of formation of stationary waves or standing waves.

Example 6.3: Find the distance between two successive nodes in a stationary wave on a string vibrating with frequency 64 Hz. The velocity of progressive wave that resulted in the stationary wave is 48 m s^{-1} .

Solution: Given:

$$\text{Speed of wave} = v = 48 \text{ m s}^{-1}$$

$$\text{Frequency } n = 64 \text{ Hz}$$

We have $v = n\lambda$

$$\therefore \lambda = \frac{v}{n} = \frac{48}{64} = 0.75 \text{ m}$$

We know that distance between successive nodes

$$= \frac{\lambda}{2} = \frac{0.75}{2} = 0.375 \text{ m}$$

6.5.4 Comparison of Progressive Waves and Stationary Waves:

1. In a progressive wave, the disturbance travels from one region to the other with definite velocity. In stationary waves, disturbance remains in the region where it is produced, velocity of the wave is zero.
2. In progressive waves, amplitudes of all particles are same but in stationary waves, amplitudes of particles are different.
3. In a stationary wave, all the particles cross their mean positions simultaneously but in a progressive wave, this does not happen.
4. In progressive waves, all the particles are moving while in stationary waves particles at the position of nodes are always at rest.
5. Energy is transmitted from one region to another in progressive waves but in stationary waves there is no transfer of energy.

6. All particles between two consecutive nodes are moving in the same direction and are in phase while those in adjacent loops are moving in opposite directions and differ in phase by 180° in stationary waves but in a progressive wave, phases of adjacent particles are different.



Do you know?

- What happens if a simple pendulum is pulled aside and released?
- What happens when a guitar string is plucked?
- Have you noticed vibrations in a drill machine or in a washing machine? How do they differ from vibrations in the above two cases?
- A vibrating tuning fork of certain frequency is held in contact with table top and vibrations are noticed and then another vibrating tuning fork of different frequency is held on table top. Are the vibrations produced in the table top the same for both the tuning forks? Why?

6.6 Free and Forced Vibrations:

The frequency at which an object tends to vibrate when hit, plucked or somehow disturbed is known as its natural frequency. In these vibrations, object is not under the influence of any outside force.

When a simple pendulum is pulled aside and released, it performs free vibrations with its natural frequency. Similarly when a string of guitar is plucked at some point it performs free vibrations with its natural frequency.

In free vibration, the body at first is given an initial displacement and the force is then withdrawn. The body starts vibrating and continues the motion on its own. No external force acts on the body further to keep it in motion.

Free vibration of a system means that the system vibrates at its natural frequency. In case of free vibrations, a body continuously

loses energy due to frictional resistance of surrounding medium. Therefore, the amplitude of vibrations goes on decreasing, the vibrations of the body eventually stop and the body comes to rest.

The vibrations in a drill machine and in a washing machine are forced vibrations. Also the vibrations produced in the table top due to tuning forks of two different frequencies are different as they are forced vibrations due to two tuning forks of different frequencies.

In forced vibrations, an external periodic force is applied on a body whose natural period is different from the period of the force. The body is made to vibrate with a frequency equal to that of the externally impressed force. The amplitude of forced vibrations depends upon the difference between the frequency of external periodic force and the natural frequency of the body. If this difference is small, the amplitude of forced vibrations is large and vice versa. If the frequencies exactly match, it is termed as resonance and the amplitude of vibration is maximum.

An object vibrating with its natural frequency can cause another nearby object to vibrate. The second object absorbs the energy transmitted by the first object and starts vibrating if the natural frequencies of the two objects match. You have seen the example of two simple pendula supported from a string in the previous chapter. The second object is said to undergo forced vibrations. Strings or air columns can also undergo forced oscillations if the frequency of the external source of sound is close to the natural frequency of the system. Resonance is said to occur and we hear a louder sound.

6.7 Harmonics and Overtones:

When a string or an air column is set into vibrations by some means, the waves are reflected from the ends and stationary waves can be formed. An important condition to form stationary waves depends on the boundary

conditions that constrain the possible wavelengths or frequencies of vibration of the system. These are called the natural frequencies of normal modes of oscillations. The minimum of these frequencies is termed the fundamental frequency or the first harmonic. The corresponding mode of oscillations is called the fundamental mode or fundamental tone. The term overtone is used to represent higher frequencies. The first frequency higher than the fundamental frequency is called the first overtone, the next frequency higher is the second overtone and so on. The term 'harmonic' is used when the frequency of a particular overtone is an integral multiple of the fundamental frequency. In strings and air columns, the frequencies of overtones are integral multiples of the fundamental frequencies, hence they are termed as harmonics. But all harmonics may not be present in a given sound. The overtones are only those multiples of fundamental frequency which are actually present in a given sound. The harmonics may or may not be present in the sound so produced.

To understand the concept of harmonics and overtones, let us study vibrations of air column.

6.7.1 End Correction:

When an air column vibrates either in a pipe closed at one end or open at both ends, boundary conditions demand that there is always an antinode at the open end(s) (since the particles of the medium are comparatively free) and a node at the closed end (since there is hardly any freedom for the particles to move). The antinode is not formed exactly at the open end but it is slightly beyond the open end as air is more free to vibrate there in comparison to the air inside the pipe. Also as air particles in the plane of open end of the pipe are not free to move in all directions, reflection takes place at the plane at small distance outside the pipe.

The distance between the open end of the pipe and the position of antinode is called the end correction. According to Reynold, to the first approximation, the end correction *at an end* is given by $e = 0.3d$, where d is the inner diameter of the pipe. Thus the length L of air column is different from the length l of the pipe.

For a pipe closed at one end

The corrected length of air column $L =$ length of air column in pipe $l +$ end correction at the open end.

$$\therefore L = l + e \quad \text{--- (6.13)}$$

For a pipe open at both ends

The corrected length of air column $L =$ length of air column in pipe $l +$ end corrections at both the ends.

$$\therefore L = l + 2e \quad \text{--- (6.14)}$$

6.7.2 Vibrations of air column in a pipe closed at one end:

Consider a long cylindrical tube closed at one end. It consists of an air column with rigid boundary at one end. When a vibrating tuning fork is held near the open end of the closed pipe, sound waves are sent by the fork inside the tube. Longitudinal waves traveling along a pipe of finite length are reflected at the ends as transverse waves are reflected at the fixed ends of a string. The phase of the reflected wave depends on whether the end of the pipe is open or closed and how wide or narrow the pipe is in comparison to the wavelength of longitudinal wave like a sound wave.

At the closed end there is least freedom for motion of air particles. Thus, there must be a node at the closed end. The particles little beyond the open end are most free to vibrate. As a result, an antinode must be formed little beyond the open end. The length l of pipe and length L of air column are shown separately in all the figures (refer Figs. 6.9 and 6.10).

The first mode of vibrations of air column closed at one end is as shown in Fig. 6.9 (a).

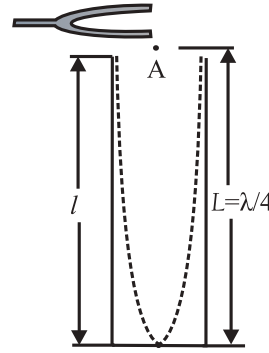

Fig. 6.9 (a): Set-up for generating vibrations of air column in a pipe closed at one end. The distance of the antinode from the open end of the pipe has been exaggerated.

This is the simplest mode of vibration of air column closed at one end, known as the fundamental mode.

\therefore Length of air column

$$L = \frac{\lambda}{4} \text{ and } \lambda = 4L$$

where λ is the wavelength of fundamental mode of vibrations in air column. If n is the fundamental frequency, we have

$$v = n\lambda \quad \text{--- (6.15)}$$

$$\therefore n = \frac{v}{\lambda}$$

$$\therefore n = \frac{v}{4L} = \frac{v}{4(l+e)} \quad \text{--- (6.16)}$$

The fundamental frequency is also known as the first harmonic. It is the lowest frequency of vibration in air column in a pipe closed at one end.

The next mode of vibrations of air column closed at one end is as shown in Fig. 6.9 (b). Here the air column is made to vibrate in such a way (as shown in Fig. 6.9 (b)) that it contains a node at the closed end, an antinode at the open end with one more node and antinode in between. If n_1 is the frequency and λ_1 is the wavelength of wave in this mode of vibrations in air column, we have, the length of the air column $L = \frac{3\lambda_1}{4}$

$$\therefore \lambda_1 = \frac{4L}{3} = \frac{4(l+e)}{3} \quad \text{--- (6.17)}$$

The velocity in the second mode is given as $v = n_1\lambda_1$

$$\therefore n_1 = \frac{v}{\lambda_1} = \frac{3v}{4L} = \frac{3v}{4(l+e)}$$

$$\therefore n_1 = 3n \quad \text{--- (6.18)}$$

This frequency is the third harmonic. It is the first overtone. Remember that the overtones are always numbered sequentially.

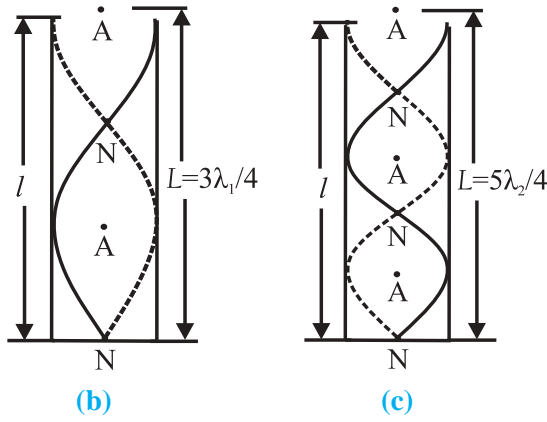

Fig. 6.9 (b) and (c): First and second overtones for vibrations of air column in a pipe closed at one end. The distance of the antinode from the open end of the pipe has been exaggerated.

The next higher mode of vibrations of air column closed at one end is as shown in Fig. 6.10 (c). Here the same air column is made to vibrate in such a way that it contains a node at the closed end, an antinode at the open end with two more nodes and antinodes in between. If n_2 is the frequency and λ_2 is the wavelength of the wave in this mode of vibrations in air column, we have

$$\text{Length of air column } L = \frac{5\lambda_2}{4}$$

$$\therefore \lambda_2 = \frac{4L}{5} = \frac{4(l+e)}{5} \quad \text{--- (6.19)}$$

The velocity this mode is given as

$$v = n_2 \lambda_2$$

$$\therefore n_2 = \frac{v}{\lambda_2} = \frac{5V}{4L} = \frac{5V}{4(l+e)} \quad \therefore n_2 = 5n \quad \text{-- (6.20)}$$

This frequency is the fifth harmonic. It is the second overtone.

Continuing in a similar way, for the p^{th} overtone we get the frequency n_p as

$$n_p = (2p + 1)n. \quad \text{-- (6.21)}$$

Thus for a pipe closed at one end only odd harmonics are present and even harmonics are absent.

6.7.3 Vibrations of air column in a pipe open at both ends:

In this case boundary conditions are such that an antinode is present at each open end. When a source of sound like a tuning fork is held near one end of the pipe, it sends the waves inside the pipe.

Even though both the ends of the pipe are open, the air inside the pipe is still bound by the wall of the tube. As a result, the air inside the pipe is little denser than the air outside. When the waves travel to the other open end, there is partial reflection at the open end. The partially reflected waves superimpose with the incident waves. Under suitable conditions, stationary waves will be formed. There is maximum freedom for motion of air column at both the ends as pipe is open at both ends.

Suppose a compression produced by a tuning fork travels through the air column. It

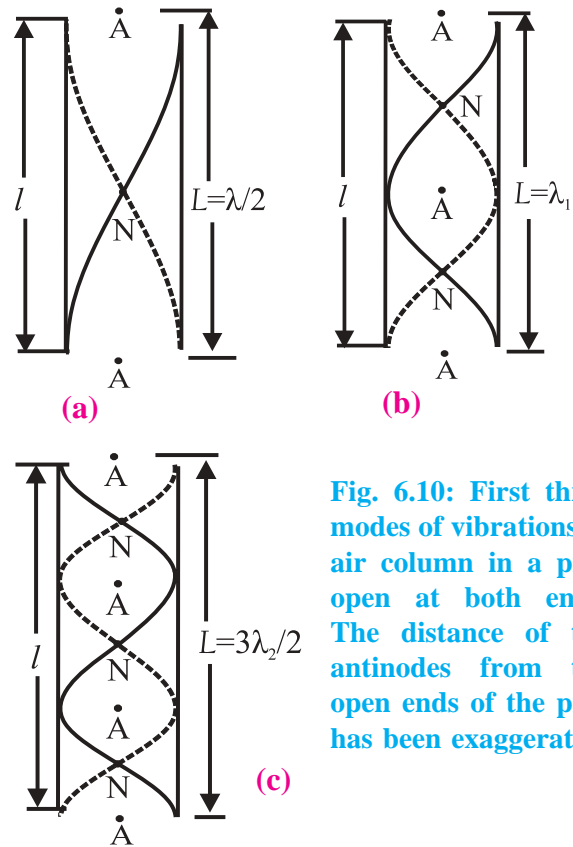

Fig. 6.10: First three modes of vibrations of air column in a pipe open at both ends. The distance of the antinodes from the open ends of the pipe has been exaggerated.

gets reflected as a rarefaction at open end. The rarefaction moves back and gets reflected as compression at the other end. It suffers second reflection at open end near the source and then interferes with the wave coming in by a path difference of $2L$.

The different modes of vibrations of air column in pipe open at both ends are shown in Fig. 6.10 (a), (b) and (c). The fundamental tone or mode of vibrations of air column open at both ends is as shown in Fig. 6.10 (a). There

are two antinodes at two open ends and one node between them.

$$\therefore \text{Length of air column} = L = \frac{\lambda}{2} \text{ or, } \lambda = 2L$$

$$\therefore n = \frac{v}{\lambda} = \frac{v}{2L} = \frac{v}{2(l+2e)} \quad \text{----(6.22)}$$

$$\text{and } v = 2nL \quad \text{----(6.23)}$$

This is the fundamental frequency or the first harmonic. It is the lowest frequency of vibration.

The next possible mode of vibrations of air column open at both ends is as shown in Fig. 6.10 (b). Three antinodes and two nodes are formed.

$$\therefore \text{Length of air column} = L = \lambda_1$$

$$\text{i.e., } \lambda_1 = L = (l+2e) \quad \text{----(6.24)}$$

If n_1 and λ_1 are frequency and wavelength of this mode of vibration of air column respectively, then

$$v = n_1 \lambda_1$$

$$n_1 = \frac{v}{\lambda_1} = \frac{v}{L} = \frac{v}{(l+2e)}$$

$$\therefore n_1 = 2n \quad \text{--- (6.25)}$$

This is the frequency of second harmonic or first overtone.

In the next of vibrations of air column open at both ends (as shown in Fig. 6.10 (c)), four antinodes and three nodes are formed.

$$\therefore \text{Length of air column} = L = \frac{3\lambda_2}{2}$$

$$\therefore \lambda_2 = \frac{2L}{3} = \frac{2(l+2e)}{3} \quad \text{--- (6.26)}$$

If n_2 and λ_2 are the frequency and wavelength of this mode of vibration of air column respectively, then $v = n_2 \lambda_2$

$$\therefore n_2 = \frac{v}{\lambda_2} = \frac{3v}{2L} = \frac{3v}{2(l+2e)}$$

$$\therefore n_2 = 3n \quad \text{--- (6.27)}$$

This is the frequency of third harmonic or second overtone.

Thus all harmonics are present as overtones in the modes of vibration of air column open at both ends.

Continuing in this manner, the frequency n_p for p^{th} overtone is,

$$n_p = (p+1)n \quad \text{--- (6.28)}$$

where n is the fundamental frequency and $p = 0, 1, 2, 3, \dots$

It may be noted that

1. Sound produced by an open pipe contains all harmonics. Its quality is richer than that produced by a closed pipe.
2. Fundamental frequency of vibration of air column in an open pipe is double that of the fundamental frequency of vibration in a closed pipe of the same length.

Using the formula and knowing values of n , l and end correction velocity of sound in air at room temperature can be calculated. As discussed earlier, the antinodes are formed little beyond the open ends of the pipe. It is however not possible to locate the positions of the antinodes precisely. Therefore, in experiments, the length of the pipe is measured and end corrections are incorporated.

6.7.4 Practical Determination of End Connection:

An exact method to determine the end correction, using two pipes of same diameter but different lengths l_1 and l_2 is as follows.

For a pipe open at both ends:

$$v = 2n_1 L_1 = 2n_2 L_2 \quad \text{using Eq. (6.23)}$$

$$\therefore n_1 L_1 = n_2 L_2$$

$$\therefore n_1 (l_1 + 2e) = n_2 (l_2 + 2e)$$

$$\therefore e = \frac{n_1 l_1 - n_2 l_2}{2(n_2 - n_1)} \text{ or } \frac{n_2 l_2 - n_1 l_1}{2(n_1 - n_2)} \quad \text{--- (6.29)}$$

For a pipe closed at one end:

$$v = 4n_1 L_1 = 4n_2 L_2$$

$$\therefore n_1 L_1 = n_2 L_2$$

$$\therefore n_1 (l_1 + e) = n_2 (l_2 + e)$$

$$\therefore e = \frac{n_1 l_1 - n_2 l_2}{2(n_2 - n_1)} \text{ or } \frac{n_2 l_2 - n_1 l_1}{2(n_1 - n_2)} \quad \text{--- (6.30)}$$



Remember this

For correct value of end correction, the inner diameter of pipe must be uniform throughout its length. It may be noted that effect of flow of air and effect of temperature of air outside the tube has been neglected.

Example 6.4: An air column is of length 17 cm long. Calculate the frequency of 5th overtone if the air column is (a) closed at one end and (b) open at both ends. (Velocity of sound in air = 340 ms⁻¹).

Solution: Given

Length of air column = 17cm = 0.17m

Overtone number $p = 5$ and velocity of sound in air = 340 ms⁻¹.

For an air column closed at one end,

$$\text{Fundamental frequency } n = \frac{v}{4L} = \frac{340}{4 \times 0.17} = 500 \text{ Hz}$$

$$\begin{aligned} \text{For fifth overtone, } n_p &= (2p + 1)n \\ &= (2 \times 5 + 1) \times 500 \\ &= 5500 \text{ Hz} \end{aligned}$$

For an air column open at both ends,

$$\begin{aligned} \text{Fundamental frequency } n &= \frac{v}{2L} = \frac{340}{2 \times 0.17} \\ n &= 1000 \text{ Hz} \end{aligned}$$

$$\begin{aligned} \text{For fifth overtone, } n_p &= (p + 1)n \\ n_p &= (2p + 1)n^c \text{ and } n^c = \frac{4}{4L} \\ n_5 &= 6000 \text{ Hz} \end{aligned}$$

Example 6.5 : A closed pipe and an open pipe have the same length. Show that no mode of the closed pipe has the same wavelength as any mode of the open pipe.

Solution: For a closed pipe (that is a pipe closed at one end and open at the other), the frequency of allowed modes is given by

$$n_p^c = (2p + 1)n^c \text{ and } n^c = \frac{4}{4L}$$

using Eqs. (6.21) and (6.16), where p is any integer.

$$\therefore \lambda_p^c = \frac{4L}{2p + 1}, \text{ where } p \text{ is any integer.}$$

On the other hand, for an open pipe (that is pipe open at both the ends), the frequency of allowed modes is given as $n_m^o = \frac{2L}{m+1}$, where m is an integer.

$$\text{If } \lambda_p^c = \lambda_m^o, \text{ it would mean } \frac{4L}{2p + 1} = \frac{2L}{m + 1}.$$

Or, $2(m + 1) = 2p + 1$ which is not possible. Hence the two pipes cannot have modes with the same frequency or wavelength.



Activity

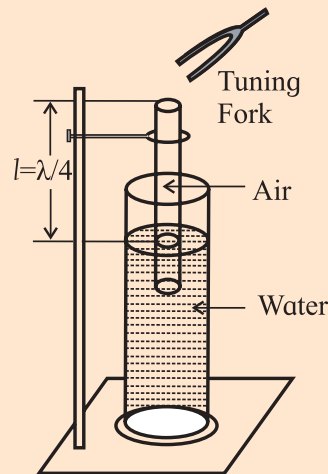

Take a glass tube open at both ends and clamp it so that its one end dips into a glass cylinder containing water as shown in the accompanying figure. By changing the position of the tube at the clamp,

you can adjust the length of the air column in the tube. Hold a vibrating tuning fork of frequency 488 Hz or 512 Hz just above the open end of the tube and make the air column vibrate. What is the difference between the sounds that you hear? The sound will be louder. This is an example of resonance. This set-up is a resonance tube. Note the heights of the air column when you hear louder sound. Interpret your observations.

Take another tuning fork of the same frequency as the first one. Vibrate them together above the open end of the tube. Do you hear beats? If the two tuning forks are of same frequency, you should not hear beats. In practice, due to usage, frequencies change and in most of the cases, you will hear beats. If you do not hear beats, there can be two reasons : (i) frequencies of the two forks are exactly same or (ii) the frequencies are very much different (difference greater than 6-7 Hz) and we cannot recognize the beats. Then wind a piece of thread around the tong of one of the tuning fork so that its frequency changes slightly. Try to hear the beats. By changing the position of the thread, vary the frequency and note down your observations systematically. What information you get from this activity?



Activity

Take two pipes of slightly different diameters, open at both the ends, so that one pipe can be moved freely inside the other. Keep the wider pipe fixed by clamping on a stand and move the other pipe up and down by hand as shown in the accompanying figure. Use a tuning fork of frequency 320 Hz or 288 Hz and keep it above the open end of the fixed pipe. Move the inner tube and try to hear the various sound patterns and write down your observations. Try to analyze the results based on the knowledge you have from the sound pattern formed with a pipe open at both ends.

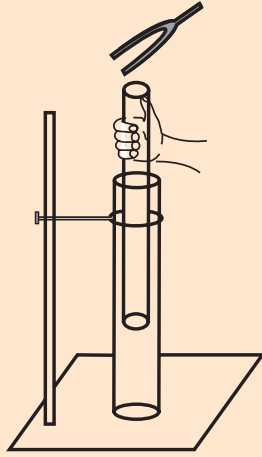

6.7.5 Vibrations Produced in a String:

Consider a string of length l stretched between two rigid supports. The linear density (mass per unit length of string) is m and the tension T acts on the string due to stretching. If it is made to vibrate by plucking or by using a vibrator like a tuning fork, a transverse wave can be produced along the string.

When the wave reaches to the fixed ends of the string, it gets reflected with change of phase by π radians. The reflected waves interfere with the incident wave and stationary waves are formed along the string. The string vibrates with different modes of vibrations.

If a string is stretched between two rigid supports and is plucked at its centre, the string vibrates as shown in Fig 6.11 (a). It consists of an antinode formed at the centre and nodes at the two ends with one loop formed along its length. If λ is the wavelength and l is the length of the string, we get

$$\text{Length of loop} = \frac{\lambda}{2} = l$$

$$\therefore \lambda = 2l$$

The frequency of vibrations of the string,

$$n = \frac{v}{\lambda} = \frac{1}{2l} \sqrt{\frac{T}{m}} \quad \left(\because v = \sqrt{\frac{T}{m}} \right)$$

This is the lowest frequency with which the string can vibrate. It is the fundamental

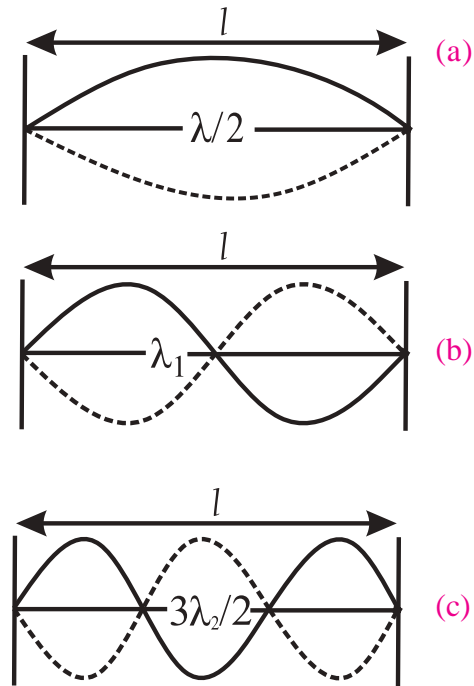

Fig. 6.11: Different modes of vibrations of a stretched string.

frequency of vibrations or the first harmonic.

If the centre of the string is prevented from vibrating by touching it with a light object and string is plucked at a point midway between one of the segments, the string vibrates as shown in Fig. 6.11 (b).

Two loops are formed in this mode of vibrations. There is a node at the centre of the string and at its both ends. If λ_1 is wavelength of vibrations, the length of one loop = $\frac{\lambda_1}{2} = \frac{l}{2}$

$$\therefore \lambda_1 = l$$

Thus, the frequency of vibrations is given as

$$n_1 = \frac{1}{\lambda_1} \sqrt{\frac{T}{m}}$$

$$n_1 = \frac{1}{l} \sqrt{\frac{T}{m}}$$

Comparing with fundamental frequency we get that $n_1 = 2n$.

Thus the frequency of the first overtone or second harmonic is equal to twice the fundamental frequency.

The string is made to vibrate in such a way that three loops are formed along the string as shown in Fig. 6.11 (c). If λ_2 is the wavelength here, the length of one loop is $\frac{\lambda_2}{2} = \frac{l}{3}$

$$\therefore \lambda_2 = \frac{2l}{3}$$

Therefore the frequency of vibrations is

$$n_2 = \frac{1}{\lambda_2} \sqrt{\frac{T}{m}}$$

$$n_2 = \frac{3}{2l} \sqrt{\frac{T}{m}}$$

Comparing with fundamental frequency, we get that $n_2 = 3n$.

Thus frequency of second overtone or third harmonic is equal to thrice the fundamental frequency. Similarly for higher modes of vibrations of the string, the frequencies of vibrations are as $4n, 5n, 6n \dots$ etc. Thus all harmonics are present in case of a stretched string and the frequencies are given by

$$n_p = pn \quad \text{--- (6.25)}$$

Example 6.6: A string is fixed at both ends. What is the ratio of the frequency of the first harmonic to that of the second harmonic?

Solution: For a string of length l fixed at both ends, the wavelengths of the first and second harmonics are given as $l = \lambda/2$ and $l = \lambda_1$ respectively. Hence the ratio of their frequencies is

$$\frac{n}{n_1} = \frac{v/\lambda}{v/\lambda_1} = \frac{\lambda_1}{\lambda} = \frac{l}{2l} = \frac{1}{2}$$

Example 6.7: The velocity of a transverse wave on a string of length 0.5 m is 225 m/s. (a) What is the fundamental frequency of a standing wave on this string if both ends are

kept fixed? (b) While this string is vibrating in the fundamental harmonic, what is the wavelength of sound produced in air if the velocity of sound in air is 330 m/s?

Solution: The wavelength of the fundamental mode is $\lambda = 2l$, hence the fundamental frequency is

$$n = \frac{v}{2l} = \frac{225 \text{ m/s}}{2 \times 0.5 \text{ m}} = 225 \text{ s}^{-1} = 225 \text{ Hz}$$

While the string is vibrating in the fundamental harmonic, the frequency of the sound produced by the string will be same as the fundamental frequency of the string. The wavelength of sound produced is $\frac{v_s}{n} = \frac{330 \text{ m/s}}{225 \text{ s}^{-1}} = 1.467 \text{ m}$.

6.7.6 Laws of a Vibrating String :

The fundamental frequency of a vibrating string under tension is given as

$$n = \frac{1}{2l} \sqrt{\frac{T}{m}}, \quad \text{--- (6.32)}$$

From this formula, three laws of vibrating string can be given as follows:

1) Law of length: The fundamental frequency of vibrations of a string is inversely proportional to the length of the vibrating string, if tension and mass per unit length are constant.

$$n \propto \frac{1}{l}, \text{ if } T \text{ and } m \text{ are constant. --- (6.33)}$$

2) Law of tension: The fundamental frequency of vibrations of a string is directly proportional to the square root of tension, if vibrating length and mass per unit length are constant.

$$n \propto \sqrt{T}, \text{ if } l \text{ and } m \text{ are constant. --- (6.34)}$$

3) Law of linear density: The fundamental frequency of vibrations of a string is inversely proportional to the square root of mass per unit length (linear density), if the tension and vibrating length of the string are constant.

$$n \propto \frac{1}{\sqrt{m}}, \text{ if } T \text{ and } l \text{ are constant. --- (6.35)}$$

If r is the radius and ρ is the density of material of string, linear density is given as

Linear density = mass per unit length
 = volume per unit length \times density
 = $(\pi r^2 l/l)\rho$

As $n \propto \frac{1}{\sqrt{m}}$, if T and l are constant, we get

$$n \propto \frac{1}{\sqrt{\pi r^2 \rho}}$$

$$\therefore n \propto \frac{1}{\sqrt{\rho}} \text{ and } n \propto \frac{1}{r} \quad \text{--- (6.36)}$$

Thus the fundamental frequency of vibrations of a stretched string is inversely proportional to (i) the radius of string and (ii) the square root of the density of the material of vibrating string.

Example 6.8: A string 105 cm long is fixed at one end. The other end of string is moved up and down with frequency 15 Hz. A stationary wave, produced in the string, consists of 3 loops. Calculate the speed of progressive waves which have produced the stationary wave in the string.

Solution: Given

Length of string = $l = 105 \text{ cm} = 3 \text{ loops}$

$$\therefore l = 3 \frac{\lambda}{2}$$

$$\therefore \lambda = \frac{2}{3} l = \frac{2}{3} \times 105 = 70 \text{ cm} = 0.70 \text{ m}$$

Speed of wave = $v = n\lambda$

$$v = 15 \times 0.70 = 10.50 \text{ m s}^{-1}$$

6.8 Sonometer:

A sonometer consists of a hollow rectangular wooden box called the sound box. The sound box is used to make a larger mass of air vibrate so that the sound produced by the vibrating string (metal wire in this case) gets amplified. The same principle is applied in stringed instruments such as the violin, guitar, *tanpura* etc. There are two bridges P and Q along the width of the box which can be moved parallel to the length of box. A metal wire of uniform cross-section runs along the length of the box over the bridges. It is fixed at one end and its other end passes over a pulley. A hanger with suitable slotted weights can be attached to the free end of wire. By changing

the weights, the tension in the wire can be varied. The movable bridges allow us to change the vibrating length AB of the wire.

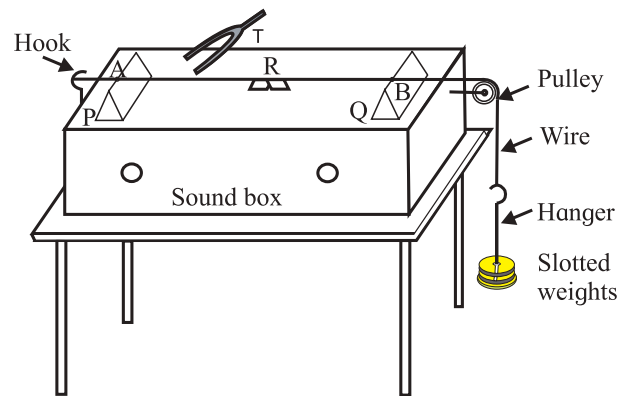

Fig. 6.12: Experimental set-up of a sonometer.

If the wire is plucked at a point midway between the bridges, transverse waves are produced in the wire. Stationary waves are produced between the two bridges due to reflection of transverse wave at the bridges and their superposition. Thus portion AB of the wire between the two bridges P and Q is the vibrating length. Wire can also be made to vibrate by holding a vibrating tuning fork near it. The frequency of vibration is then same as that of the tuning fork. If this frequency happens to be one of the natural frequencies of the wire, standing waves with large amplitude are set up in the wire since the two vibrate in resonance.

To identify the resonance, a small piece of paper, known as the rider R, is placed over the wire at a point in the middle of the length AB as determined by the position of the bridges P and Q. If the frequency of the tuning fork and of the fundamental mode of vibration of the wire match (this is achieved by adjusting the length AB of wire using the bridges P and Q), the paper rider happens to be at the antinode and flies off the wire.

Sonometer can be used to verify the laws of a vibrating string.

1) Verification of first law of a vibrating string:

By measuring length of wire and its mass, the mass per unit length (m) of wire is determined. Then the wire is stretched on the

sonometer and the hanger is suspended from its free end. A suitable tension (T) is applied to the wire by placing slotted weights on the hanger. The length of wire (l_1) vibrating with the same frequency (n_1) as that of the tuning fork is determined as follows.

A light paper rider is placed on the wire midway between the bridges. The tuning fork is set into vibrations by striking on a rubber pad. The stem of tuning fork is held in contact with the sonometer box. By changing distance between the bridges without disturbing paper rider, frequency of vibrations of wire is changed. When the frequency of vibrations of wire becomes exactly equal to the frequency of tuning fork, the wire vibrates with maximum amplitude and the paper rider is thrown off.

In this way a set of tuning forks having different frequencies n_1, n_2, n_3, \dots are used and corresponding vibrating lengths of wire are noted as l_1, l_2, l_3, \dots by keeping the tension constant (T). We will observe that $n_1 l_1 = n_2 l_2 = n_3 l_3 = \dots = \text{constant}$, for constant value of tension (T) and mass per unit length (m).

$$\therefore nl = \text{constant}$$

i.e., $n \propto \frac{1}{l}$, if T and m are constant.

Thus, the first law of a vibrating string is verified by using a sonometer.

2) Verification of second law of a vibrating string:

The vibrating length (l) of the given wire of mass per unit length (m) is kept constant for verification of second law. By changing the tension the same length is made to vibrate in unison with different tuning forks of various frequencies. If tensions T_1, T_2, T_3, \dots correspond to frequencies n_1, n_2, n_3, \dots etc. we will observe that.

$$\frac{n_1}{\sqrt{T_1}} = \frac{n_2}{\sqrt{T_2}} = \frac{n_3}{\sqrt{T_3}} = \dots = \text{constant}$$

$$\text{or } \frac{n}{\sqrt{T}} = \text{constant}$$

$\therefore n \propto \sqrt{T}$ if l and m are constant. This is the second law of a vibrating string.

3) Verification of third law of a vibrating string:

For verification of third law of a vibrating string, two wires having different masses per unit lengths m_1 and m_2 (linear densities) are used. The first wire is subjected to suitable tension and made to vibrate in unison with given tuning fork. The vibrating length is noted as (l_1). Using the same fork, the second wire is made to vibrate under the same tension and the vibrating length (l_2) is determined. Thus the frequency of vibration of the two wires is kept same under same applied tension T . It is found that,

$$l_1 \sqrt{m_1} = l_2 \sqrt{m_2}$$

$$l \sqrt{m} = \text{constant}$$

But by first law of a vibrating string, $n \propto \frac{1}{l}$

Therefore we get that, $n \propto \frac{1}{\sqrt{m}}$, if T and l are constant. This is the third law of vibrating string.

In this way, laws of a vibrating string are verified by using a sonometer.

Example 6.9: A sonometer wire of length 50 cm is stretched by keeping weights equivalent of 3.5 kg. The fundamental frequency of vibration is 125 Hz. Determine the linear density of the wire.

Solution: Given, $l = 50 \text{ cm} = 0.5 \text{ m}$, $T = 3.5 \text{ kg} \times 9.8 \text{ m/s}^2 = 34.3 \text{ N}$, $n = 125 \text{ Hz}$

$$n = \frac{1}{2l} \sqrt{\frac{T}{m}}$$

$$\therefore n^2 = \frac{1}{4l^2} \frac{T}{m}$$

$$\therefore m = \frac{T}{4n^2 l^2}$$

$$\therefore m = \frac{34.3}{4 \times (125)^2 \times (0.5)^2}$$

$$\therefore m = 2.195 \times 10^{-3} \text{ kg m}^{-1}$$

Example 6.10: Two wires of the same material and the same cross section are stretched on a sonometer in succession. Length of one wire is 60 cm and that of the other is 30 cm. An unknown load is applied to the first wire and second wire is loaded with 1.5 kg. If both the wires vibrate with the same fundamental frequencies, calculate the unknown load.

Solution: Two wires are given to be of the same material and having the same cross section,

$$\therefore m_1 = m_2 = m$$

Same fundamental frequency, $n_1 = n_2 = n$
 $l_1 = 60 \text{ cm} = 0.6 \text{ m}$, $l_2 = 30 \text{ cm} = 0.3 \text{ m}$,
 $T_2 = 1.5 \times 9.8 \text{ N}$

$$\text{For the first wire, } n_1 = \frac{1}{2l_1} \sqrt{\frac{T_1}{m_1}}$$

$$\text{For the second wire, } n_2 = \frac{1}{2l_2} \sqrt{\frac{T_2}{m_2}}$$

$$\therefore \frac{n_1}{n_2} = \frac{l_2}{l_1} \sqrt{\frac{T_1 \times m_2}{T_2 \times m_1}}$$

$$\therefore \frac{n}{n} = \frac{0.3}{0.6} \sqrt{\frac{T_1 \times m}{1.5 \times 9.8 \times m}}$$

$$\therefore 1 = \frac{1}{2} \sqrt{\frac{T_1}{1.5 \times 9.8}}$$

$$\therefore 2 = \sqrt{\frac{T_1}{1.5 \times 9.8}}$$

$$\text{or, } \therefore 4 = \frac{T_1}{1.5 \times 9.8}$$

$$\therefore T_1 = 6 \times 9.8 \text{ N}$$

$$\therefore \text{Applied load} = 6 \text{ kg.}$$

Example 6.11: A wire has linear density $4.0 \times 10^{-3} \text{ kg/m}$. It is stretched between two rigid supports with a tension of 360 N. The wire resonates at a frequency of 420 Hz and 490 Hz in two successive modes. Find the length of the wire.

Solution: Given $m = 4.0 \times 10^{-3} \text{ kg/m}$, $T = 360 \text{ N}$. Let the wire vibrate at 420 Hz and 490 Hz in its p^{th} and $(p+1)^{\text{th}}$ harmonics. Then $np = n(p+1)$ where n is the fundamental

frequency

$$420 \text{ Hz} = \frac{p}{2l} \sqrt{\frac{T}{m}} \quad \text{and} \quad 490 \text{ Hz} = \frac{p+1}{2l} \sqrt{\frac{T}{m}}$$

$$\therefore \frac{490}{420} = \frac{p+1}{p}$$

$$\text{or, } n = 6$$

Using this value of p , for the frequency of p^{th} harmonic, we get

$$420 \text{ Hz} = \frac{6}{2l} \sqrt{\frac{360 \text{ N}}{4.0 \times 10^{-3} \text{ kg/m}}} = \frac{900}{l} \text{ m/s}$$

$$\therefore l = 900/420 \text{ m} = 2.14 \text{ m}$$

6.9 Beats:

This is an interesting phenomenon based on the principle of superposition of waves. When there is superposition of two sound waves, having same amplitude but slightly different frequencies, travelling in the same direction, the intensity of sound varies periodically with time. This phenomenon is known as production of beats.

The occurrences of maximum intensity are called waxing and those of minimum intensity are called waning. One waxing and successive waning together constitute one beat. The number of beats heard per second is called beat frequency.

6.9.1 Analytical method to determine beat frequency:

Consider two sound waves, having same amplitude and slightly different frequencies n_1 and n_2 . Let us assume that they arrive in phase at some point x of the medium. The displacement due to each wave at any instant of time at that point is given as

$$y_1 = a \sin \left\{ 2\pi \left(n_1 t - \frac{x}{\lambda_1} \right) \right\}$$

$$y_2 = a \sin \left\{ 2\pi \left(n_2 t - \frac{x}{\lambda_2} \right) \right\}$$

Let us assume for simplicity that the listener is at $x = 0$.

$$\therefore y_1 = a \sin(2\pi n_1 t)$$

and $y_2 = a \sin(2\pi n_2 t)$

According to the principle of superposition of waves,

$$y = y_1 + y_2$$

$$\therefore y = a \sin(2\pi n_1 t) + a \sin(2\pi n_2 t)$$

or,

$$y = 2a \sin \left[2\pi \left(\frac{n_1 + n_2}{2} \right) t \right] \cos \left[2\pi \left(\frac{n_1 - n_2}{2} \right) t \right] \quad \dots (6.31)$$

[By using formula,

$$\sin C + \sin D = 2 \sin \left(\frac{C + D}{2} \right) \cos \left(\frac{C - D}{2} \right)]$$

Rearranging the above equation, we get

$$y = 2a \cos \left[\frac{2\pi(n_1 - n_2)}{2} t \right] \sin \left[\frac{2\pi(n_1 + n_2)}{2} t \right]$$

Substituting $2a \cos \left[\frac{2\pi(n_1 - n_2)}{2} t \right] = A$

and $\frac{n_1 + n_2}{2} = n$, we get

$$y = A \sin(2\pi n t) \quad \dots (6.37)$$

This is the equation of a progressive wave having frequency n and amplitude A . The frequency n is the mean of the frequencies n_1 and n_2 of arriving waves while the amplitude A varies periodically with time.

The intensity of sound is proportional to the square of the amplitude. Hence the resultant intensity will be maximum when the amplitude is maximum.

For maximum amplitude (waxing),

$$A = \pm 2a$$

$$\therefore 2a \cos \left[\frac{2\pi(n_1 - n_2)}{2} t \right] = \pm 2a$$

or, $\cos \left[\frac{2\pi(n_1 - n_2)}{2} t \right] = \pm 1$

i.e., $\left[2\pi \left(\frac{n_1 - n_2}{2} \right) t \right] = 0, \pi, 2\pi, 3\pi, \dots$

$$\therefore t = 0, \frac{1}{n_1 - n_2}, \frac{2}{n_1 - n_2}, \frac{3}{n_1 - n_2}, \dots$$

Thus, the time interval between two successive maxima of sound is always $\frac{1}{n_1 - n_2}$.

Hence the period of beats is $T = \frac{1}{n_1 - n_2}$.

The number of waxing heard per second is the reciprocal of period of waxing.

$$\therefore \text{frequency of beats, } N = n_1 - n_2 \quad \dots (6.33)$$

The intensity of sound will be minimum when amplitude is zero (waning):

For minimum amplitude, $A = 0$,

$$\therefore 2a \cos \left[2\pi \left(\frac{n_1 - n_2}{2} \right) t \right] = 0$$

$$\cos \left[2\pi \left(\frac{n_1 - n_2}{2} \right) t \right] = 0$$

$$\therefore \left[2\pi \left(\frac{n_1 - n_2}{2} \right) t \right] = \frac{\pi}{2}, \frac{3\pi}{2}, \frac{5\pi}{2}, \dots$$

$$\therefore t = \frac{1}{2(n_1 - n_2)}, \frac{3}{2(n_1 - n_2)}, \frac{5}{2(n_1 - n_2)}, \dots$$

Therefore time interval between two successive minima is also $\frac{1}{(n_1 - n_2)}$, which is expected.

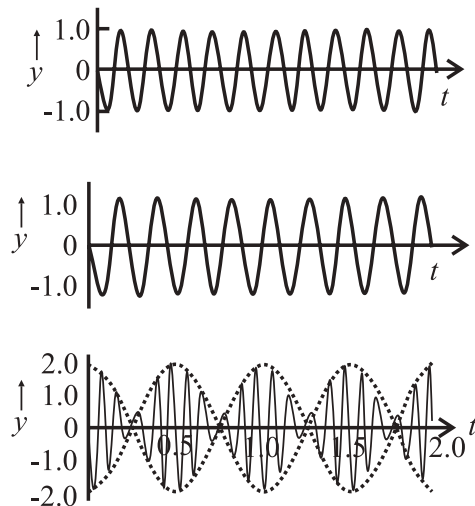

Fig. 6.13: Superposition of two harmonic waves of nearly equal frequencies resulting in the formation of beats.

By comparing the instances of successive waxing and waning, we come to know that waxing and waning occur alternately with equal frequency.

The variation in the loudness of sound that goes up and down is the phenomenon of formation of beats. It can be considered as superposition of waves and formation of standing waves in time at one point in space where waves of slightly different frequencies are passing. The two waves are in and out

of phase giving constructive and destructive interference. The interval between two maximum sound intensities is the time period of beats.



Remember this

We can hear beats if the frequency difference between the two superimposed waves is very small (practically less than 6-7 Hz, for normal human ear). At frequencies higher than these, individual beats cannot be distinguished from the sound that is produced.



Activity

- Take two tuning forks of the same frequency.
- Put some wax on the prongs of one of the forks.
- Vibrate both the tuning forks and keep them side by side.
- Listen to the periodic vibrations of loudness of resulting sound.
- How many beats have you heard in one minute?
- Can you guess whether frequency of tuning fork is increased or decreased by applying wax on the prong?
- How you can find the new frequency of the fork after applying wax on it.

6.9.2 Applications of beats :

- 1] The phenomenon of beats is used for matching the frequencies of different musical instruments by artists. They go on tuning until no beats are heard by their sensitive ears. When beat frequency becomes equal to zero, the musical instruments are in unison with each other i.e., their frequencies are identical and the effect of playing such instruments gives a pleasant music.
- 2] The speed of an airplane can be determined by using Doppler RADAR.

If either a source of sound or a listener (or both) is moving with respect to air, the listener detects a sound whose frequency is different from the frequency of the sound source. This is Doppler effect.

A microwave signal (pulse) of known frequency is sent towards the moving airplane. Principle of Doppler effect giving the apparent frequency when the source and observer are in relative motion applies twice, once for the signal sent by the microwave source and received by the airplane and second time when the signal is reflected by the airplane and is received back at the microwave source. Phenomenon of beats, arising due to the difference in frequencies produced by the source and received at the source after reflection from the air plane, allows us to calculate the velocity of the air plane.

The same principle is used by traffic police to determine the speed of a vehicle to check whether speed limit is exceeded. Sonar (**S**ound **n**avigation and **r**anging) works on similar principle for determining speed of submarines using a sound source and sensitive microphones.

Doppler ultrasonography and echo cardiogram work on similar principle. Doctors use an analogous set up to assess the direction and speed of blood flow in a human body and identify circulation problems. Measurement of the dimension of the blood vessels can be used to estimate the volume flow rate. Ultrasound beams also determine phase shifts to diagnose vascular problems in arteries and veins.

- 3] Unknown frequency of a sound note can be determined by using the phenomenon of beats. Initially the sound notes of known and unknown frequency are heard simultaneously. The known frequency from a source of adjustable frequency is adjusted in such a way that the beat frequency reduces to zero. At this stage frequencies of both the sound notes become equal. Hence unknown frequency can be determined.

Example 6.12: Two sound waves having wavelengths 81 cm and 82.5 cm produce 8 beats per second. Calculate the speed of sound in air.

Solution: Given

$$\lambda_1 = 81 \text{ cm} = 0.81 \text{ m}$$

$$\lambda_2 = 82.5 \text{ cm} = 0.825 \text{ m}$$

$$n_1 = \frac{v}{\lambda_1} = \frac{v}{0.81}$$

$$n_2 = \frac{v}{\lambda_2} = \frac{v}{0.825}$$

Here $\lambda_1 < \lambda_2$, $\therefore n_1 > n_2$.

As 8 beats are produced per second,

$$n_1 - n_2 = 8$$

$$\therefore \frac{v}{\lambda_1} - \frac{v}{\lambda_2} = 8$$

$$\therefore v \left[\frac{1}{\lambda_1} - \frac{1}{\lambda_2} \right] = 8$$

$$\therefore v \left[\frac{1}{0.81} - \frac{1}{0.825} \right] = 8$$

$$\therefore v = 356.4$$

Example 6.13: Two tuning forks having frequencies 320 Hz and 340 Hz are sounded together to produce sound waves. The velocity of sound in air is 326.4 m s⁻¹. Find the difference in wavelength of these waves.

Solution: Given

$$n_1 = 320 \text{ Hz}, n_2 = 340 \text{ Hz}, v = 326.4 \text{ m s}^{-1}$$

$$v = n_1 \lambda_1 = n_2 \lambda_2$$

Here, $n_1 < n_2$, $\therefore \lambda_1 > \lambda_2$

$$\therefore \lambda_1 - \lambda_2 = \frac{v}{n_1} - \frac{v}{n_2}$$

$$\therefore \lambda_1 - \lambda_2 = v \left[\frac{1}{n_1} - \frac{1}{n_2} \right]$$

$$\therefore \lambda_1 - \lambda_2 = 326.4 \left[\frac{1}{320} - \frac{1}{340} \right]$$

$$\therefore \lambda_1 - \lambda_2 = 0.06 \text{ m}$$

6.10 Characteristics of Sound:

Sound has three characteristics: loudness, pitch and quality.

1. Loudness: Loudness is the human perception to intensity of sound. We know that when a

sound wave travels through a medium, there are regions of compressions and rarefactions. Thus there are changes in pressure. When a sound is heard, say by a human, the wave exerts pressure on the human ear. The pressure variation is related to the amplitude and hence to the intensity. Depending on the sound produced, the variation in this pressure is from 28 Pa for the loudest tolerable sound to 2.0×10^{-5} Pa for the feeblest sound like a whisper that can be heard by a human. Intensity is a measurable quantity while the sensation of hearing or loudness is very subjective. It is therefore important to find out how does a sound of intensity I affect a detectable change ΔI in the intensity for the human ear to note. It is known that the value of such ΔI depends linearly on intensity I and this fact allows humans to deal with a large variation in intensity.

The response of human ear to sound is exponential and not linear. It depends upon the amount of energy crossing unit area around a point per unit time. Intensity is proportional to the square of amplitude. It also depends upon various other factors like distance of source from the listener, the motion of air, density of medium, the surface area of sounding body etc. The presence of other resonant objects around the sounding body also affects loudness of sound.

Scientifically, sound is specified not by its intensity but by the sound level β (expressed in *decibels* (dB)), defined as

$$\beta = 10 \log_{10} \left(\frac{I}{I_0} \right), \quad \text{--- (6.39)}$$

where I_0 is a minimum reference intensity (10^{-12} W/m²) that a normal human ear can hear. Sound levels are then expressed in decibel (dB). When $I = I_0$, $\beta = 0$, thus the standard reference intensity has measure of sound level 0 dB. The unit of difference in loudness is *bel*. You have studied about this unit in XIth Std.

$$1 \text{ decibel} = \frac{1}{10} \text{ bel}$$

As mentioned above, minimum audible sound is denoted by 0 dB while whispering and normal speech have levels 10 dB and 60 dB respectively at a distance of approximately 1 m from the source. The intensity level of maximum tolerable sound for a human ear is around 120 dB.

Loudness is different at different frequencies, even for the same intensity. For measuring loudness the unit **phon** is used. Phon is a measure of loudness. It is equal to the loudness in decibel of any equally loud pure tone of frequency 1000Hz.

2. Pitch: It is a sensation of sound which helps the listener to distinguish between a high frequency and a low frequency note. Pitch is the human perception to frequency- higher frequency denotes higher pitch. The pitch of a female voice is higher than that of a male voice.

3. Quality or timbre: Normally sound generated by a source has a number of frequency components with different amplitudes. Quality of sound is that characteristic which enables us to distinguish between two sounds of same pitch and loudness. We can recognize the voice of a person or an instrument due to its quality of sound. Quality depends on number of overtones present in the sound along with a given frequency.

A sound which produces a pleasing sensation to the ear is a musical sound. It is produced by regular and periodic vibrations without any sudden change in loudness. Musical sound has certain well-defined frequencies with sizable amplitude; these are normally harmonics of a fundamental frequency. A mixture of sounds of different frequencies which do not have any relation with each other produces what we call a noise. Noise therefore is not pleasant to hear. If in addition, it is loud, it may cause headaches.

A sequence of frequencies which have a specific relationship with each other is called a musical scale. Normally both in Indian classical music and western classical music, eight frequencies, in specific ratio, form an octave, each frequency denoting a specific note. In a given octave frequency increases along sa re ga ma pa dha ni sã (as well as along Do Re Mi Fa So La Ti Dò). An example of values of frequencies is 240, 270, 300, 320, 360, 400, 450, 480 Hz respectively.

6.11 Musical instruments:

Audible waves originate in vibrating strings, vibrating air columns and vibrating plates and membranes. Accordingly, musical instruments are classified into three main types.

(a) Stringed instruments (b) wind instruments (c) percussion instruments.

a) Stringed instruments: consist of stretched strings. Sound is produced by plucking of strings. The strings are tuned to certain frequencies by adjusting tension in them. They are further of three different types.

1) Plucked string type: In these instruments string is plucked by fingers, e.g., *tanpura*, *sitar*, guitar, *veena*, etc.

2) Bowed string type: In these instruments, a string is played by bowing, e.g., violin, *sarangi*.

3) Struck string type: the string is struck by a stick, e.g. *santoor*, piano.

b) Wind instruments: These instruments consist of air column. Sound is produced by setting vibrations of air column. They are further of three different types

1) Freewind type: In these instruments free brass reeds are vibrated by air. The air is either blown or compressed. e.g., mouth organ, harmonium etc.

2) Edge type: In these instruments air is blown against an edge. e.g., Flute.

3) Reedpipes: They may consists of single or double reeds and also instruments without reeds .e.g., saxophone, clarinet (single reed), bassoon (double reed), bugle (without reed).

c) Percussion instruments: In these instruments sound is produced by setting vibrations in a stretched membrane. e.g., tabla, drum, dhol, mridangam, sambal, daphali, etc. They also consist of metal type of instruments which produce sound when they struck against each other or with a beater. e.g., cymbals (i.e., jhanja), xylophone, etc.

A blow on the membrane or plate or plucking of string produces vibrations with one fundamental and many overtones. A superposition of several natural modes of oscillations with different amplitudes and hence intensities characterize different musical instruments. We can thus distinguish the instruments by their sounds.

Production of different notes by musical instrument depends on the creation of stationary waves. For a stringed instrument such as guitar or sitar, the two ends of the string are fixed. Depending as where the string is plucked, stationary waves of various modes midpoint minimum. In wind instruments, air column is made to vibrate by blowing. By changing the length of air column note can be changed. In wind instrument like flute, holes can be uncovered to change the vibrations of air column this changes the pattern of nodes and antinodes.

In practice, sound produced is made up of several stationary waves having different patterns of nodes and antinodes. Musicians skill is stimulating the string or air column to produce direct mixture of frequencies.



Do you know?

Sir C.V. Raman, the great physicist and the first Noble Laureate of India, had done research on the Indian classical musical instruments such as *mridangam* and *tabla*. Read more about his research work in this field from website: <https://www.livehistoryindia.com> c.v.ramans work on Indian music.



Internet my friend

- <https://www.acs.psu.edu/drussell/Demos/superposition/superposition.html>
- <https://www.acs.psu.edu/drussell/demos.html>
- <https://www.google.com/search?client=firefox-b-d&q=superposition+of+waves>
- https://www.youtube.com/watch?v=J_Oto3mUIuk
- <https://www.youtube.com/watch?v=GSP5LqGtkeE>
- <https://www.acs.psu.edu/drussell/Demos/StandingWaves/StandingWaves.html>
- <https://www.physicsclassroom.com/class/waves/Lesson-4/Formation-of-Standing-Waves>
- <https://www.physicsclassroom.com/class/waves/Lesson-4/Formation-of-Standing-Waves>
- <https://www.youtube.com/watch?v=-D9UIPcJSRM>
- <https://www.youtube.com/watch?v=jHjXNFmm8y4>
- <https://www.youtube.com/watch?v=BWqyXHKhaZ8>
- <https://physics.info/waves-standing/>
- https://www.youtube.com/watch?v=nrJrV_Gn_Cw&t=661s

**Exercises****1. Choose the correct option.**

- i) When an air column in a pipe closed at one end vibrates such that three nodes are formed in it, the frequency of its vibrations istimes the fundamental frequency.
(A) 2 (B) 3 (C) 4 (D) 5
- ii) If two open organ pipes of length 50 cm and 51 cm sounded together produce 7 beats per second, the speed of sound is.
(A) 307 m/s (B) 327m/s
(C) 350m/s (D) 357m/s
- iii) The tension in a piano wire is increased by 25%. Its frequency becomes times the original frequency.
(A) 0.8 (B) 1.12 (C) 1.25 (D) 1.56
- iv) Which of the following equations represents a wave travelling along the y-axis?
(A) $x = A \sin(ky - \omega t)$
(B) $y = A \sin(kx - \omega t)$
(C) $y = A \sin(ky) \cos(\omega t)$
(D) $y = A \cos(ky) \sin(\omega t)$
- v) A standing wave is produced on a string fixed at one end with the other end free. The length of the string
(A) must be an odd integral multiple of $\lambda/4$.
(B) must be an odd integral multiple of $\lambda/2$.
(C) must be an odd integral multiple of λ .
(D) must be an even integral multiple of λ .

2. Answer in brief.

- i) A wave is represented by an equation $y = A \sin(Bx + Ct)$. Given that the constants A, B and C are positive, can you tell in which direction the wave is moving?
- ii) A string is fixed at the two ends and is vibrating in its fundamental mode. It is known that the two ends will be at rest. Apart from these, is there any position on

the string which can be touched so as not to disturb the motion of the string? What will be the answer to this question if the string is vibrating in its first and second overtones?

- iii) What are harmonics and overtones?
- iv) For a stationary wave set up in a string having both ends fixed, what is the ratio of the fundamental frequency to the second harmonic?
- v) The amplitude of a wave is represented by $y = 0.2 \sin 4\pi \left[\frac{t}{0.08} - \frac{x}{0.8} \right]$ in SI units.

Find (a) wavelength, (b) frequency and (c) amplitude of the wave.

- State the characteristics of progressive waves.
- State the characteristics of stationary waves.
- Derive an expression for equation of stationary wave on a stretched string.
- Find the amplitude of the resultant wave produced due to interference of two waves given as $y_1 = A_1 \sin \omega t$ $y_2 = A_2 \sin(\omega t + \phi)$
- State the laws of vibrating strings and explain how they can be verified using a sonometer.
- Show that only odd harmonics are present in the vibrations of air column in a pipe closed at one end.
- Prove that all harmonics are present in the vibrations of the air column in a pipe open at both ends.
- A wave of frequency 500 Hz is travelling with a speed of 350 m/s.
(a) What is the phase difference between two displacements at a certain point at times 1.0 ms apart? (b) what will be the smallest distance between two points which are 45° out of phase at an instant of time?

[Ans : π , 8.75 cm]

11. A sound wave in a certain fluid medium is reflected at an obstacle to form a standing wave. The distance between two successive nodes is 3.75 cm. If the velocity of sound is 1500 m/s, find the frequency.
[Ans : 20 kHz]
12. Two sources of sound are separated by a distance 4 m. They both emit sound with the same amplitude and frequency (330 Hz), but they are 180° out of phase. At what points between the two sources, will the sound intensity be maximum?
[Ans: ± 0.25 , ± 0.75 , ± 1.25 and ± 1.75 m from the point at the center]
13. Two sound waves travel at a speed of 330 m/s. If their frequencies are also identical and are equal to 540 Hz, what will be the phase difference between the waves at points 3.5 m from one source and 3 m from the other if the sources are in phase?
[Ans : 1.64π]
14. Two wires of the same material and same cross section are stretched on a sonometer. One wire is loaded with 1.5 kg and another is loaded with 6 kg. The vibrating length of first wire is 60 cm and its fundamental frequency of vibration is the same as that of the second wire. Calculate vibrating length of the other wire.
[Ans: 1.2 m]
15. A pipe closed at one end can produce overtones at frequencies 640 Hz, 896 Hz and 1152 Hz. Calculate the fundamental frequency.
[Ans: 128 Hz]
16. A standing wave is produced in a tube open at both ends. The fundamental frequency is 300 Hz. What is the length of tube? (speed of the sound = 340 m s^{-1}).
[Ans: 0.57 m]
17. Find the fundamental, first overtone and second overtone frequencies of a pipe, open at both the ends, of length 25 cm if the speed of sound in air is 330 m/s.
[Ans: 660 Hz, 1320 Hz, 1980 Hz]
18. A pipe open at both the ends has a fundamental frequency of 600 Hz. The first overtone of a pipe closed at one end has the same frequency as the first overtone of the open pipe. How long are the two pipes?
[Ans : 27.5 cm, 20.625 cm]
19. A string 1m long is fixed at one end. The other end is moved up and down with frequency 15 Hz. Due to this, a stationary wave with four complete loops, gets produced on the string. Find the speed of the progressive wave which produces the stationary wave.[Hint: Remember that the moving end is an antinode.]
[Ans: 6.67 m s^{-1}]
20. A violin string vibrates with fundamental frequency of 440Hz. What are the frequencies of first and second overtones?
[Ans: 880 Hz, 1320 Hz]
21. A set of 8 tuning forks is arranged in a series of increasing order of frequencies. Each fork gives 4 beats per second with the next one and the frequency of last fork is twice that of the first. Calculate the frequencies of the first and the last fork.
[Ans: 28 Hz, 56 Hz]
22. A sonometer wire is stretched by tension of 40 N. It vibrates in unison with a tuning fork of frequency 384 Hz. How many numbers of beats get produced in two seconds if the tension in the wire is decreased by 1.24 N?
[Ans: 12 beats]
23. A sonometer wire of length 0.5 m is stretched by a weight of 5 kg. The fundamental frequency of vibration is 100 Hz. Calculate linear density of wire.
[Ans: $4.9 \times 10^{-3} \text{ kg/m}$]
24. The string of a guitar is 80 cm long and has a fundamental frequency of 112 Hz. If a guitarist wishes to produce a frequency of 160 Hz, where should the person press the string?
[Ans : 56 cm]

7. Wave Optics



Can you recall?

1. What does the formation of shadows tell you about the propagation of light?
2. What are laws of reflection and refraction?
3. What are electromagnetic waves?
4. What is the range of frequencies of visible light?
5. What is meant by the phase at a point along the path of a wave?

7.1 Introduction:

In earlier standards we have learnt that light travels in a straight line while travelling through a uniform and homogeneous medium. The path of light is called a ray of light. On encountering an interface with another medium, a ray of light gets reflected or refracted, changes its direction and moves along another straight line. The reflection is such that (i) the incident ray, the reflected ray and the normal to the boundary surface at the point of incidence are in the same plane and (ii) the angle of incidence, i.e., the angle between the incident ray and the normal to the reflecting surface, is equal to the angle of reflection, i.e., the angle between the reflected ray and the normal. For refraction of light while travelling from medium 1 to medium 2, the laws are (i) the incident ray, the refracted ray and the normal to the boundary between the two media at the point of incidence are in the same plane and (ii) the angle of incidence i , and the angle of refraction r , are related by $n_1 \sin i = n_2 \sin r$, where, n_1 and n_2 are the absolute refractive indices of medium 1 and medium 2 respectively.

We have also learnt about the reflection of light produced by spherical mirrors and refraction of light through prisms and curved surfaces of lenses. The position and nature of

the image (whether real or virtual) depend on the position of objects and the focal length of the mirror or lens.

7.2 Nature of Light

7.2.1 Corpuscular Nature:

The formation of shadows as well as images by mirrors and lenses has been understood by considering rectilinear motion of light rays. This fact led R. Descartes (1596-1650) to propose a particle nature of light in the year 1636. Newton (1642-1726) developed this concept further and proposed that light is made up of particles, i.e., corpuscles which are hard, elastic and massless. A source of light emits these corpuscles which travel along straight lines in the absence of any external force. When the light corpuscles strike a reflecting surface, they undergo elastic collisions and as a result follow the laws of reflection. During refraction, it is the difference in the attractive force between the corpuscles and the particles of the medium that causes a change in the direction of the corpuscles. A denser medium exerts a larger attractive force on light corpuscles to accelerate them along the normal to the boundary. Thus, Newton's theory predicted that the speed of light in denser medium would be higher than that in a rarer medium. This contradicts the experimental observation. In this theory, light of different colours corresponds to corpuscles of different sizes. Newton performed several experiments in optics and could explain their results based on his theory. The study of optical phenomena under the assumption that it travels in a straight line as a ray is called *ray optics* or *geometrical optics* as geometry is used in this study. The laws of reflection and refraction and the formation of images that we studied in earlier standards fall under this category.

7.2.2 Wave Nature:

To circumvent the difficulties in corpuscular theory, it was proposed by the Dutch physicist C. Huygens (1629-1695) in the year 1668, that light is a wave. Huygens assumed light to be a wave caused by vibrations of the particles of the medium. As light could also travel in vacuum, he assumed that a hypothetical medium, called ether is present everywhere including in vacuum. Note that this ether is not the substance (ether gas) that we come across in chemistry. There was however, no evidence to prove its existence and thus, it was difficult to accept the concept.

In the nineteenth century, certain new phenomena of light namely, interference, diffraction and polarization were discovered. These could not be explained based on corpuscular theory and needed wave theory for their explanation. Huygens' theory could not only explain the new phenomena but could also explain the laws of reflection and refraction, as well as the formation of images by mirrors and lenses. It was then accepted as the correct theory of light. Wave theory showed that if the speed of light waves in denser medium is smaller than that in rarer medium then light bends towards normal. Thus, wave nature of light could explain all the visual effects exhibited by light. The branch of optics which uses wave nature of light to explain the optical phenomena is called *wave optics*.

In this chapter we are going to study wave optics and learn how the laws of reflection and refraction can be explained assuming the wave nature of light. We will also learn about the phenomena of interference, diffraction and polarization and their explanation based on wave optics. The reason why geometrical optics works in case of formation of shadows, reflection and refraction is that the wavelength of light is much smaller than the reflecting/refracting surfaces as well as the shadow

causing objects that one encounters in laboratory or in day-to-day life.

In XIth Std we have learnt Maxwell's equations which suggested that light is an electromagnetic wave. As all waves known till Maxwell's time needed a medium to propagate, Maxwell invoked the all-pervading hypothetical medium ether. The existence of radio waves and their speed being same as that of visible light, were experimentally verified by H. Hertz later in the nineteenth century. Michelson and Morley performed several experiments to detect ether but obtained negative result. The hypothesized ether was never detected, and its existence and necessity was ruled out by Albert Einstein (1879-1955) when he proposed the special theory of relativity in the year 1905, based on a revolutionary concept of constancy of velocity of light.

7.2.3 Dual Nature of Light:

In the early twentieth century, it was accepted that light has a dual nature. It can exhibit particle nature as well as wave nature under different situations. Particles of light are called photons. We will learn more about it in Chapter 14.

7.3 Light as a Wave:

Light is an electromagnetic wave. These waves are transverse in nature and consist of tiny oscillating electric and magnetic fields which are perpendicular to each other and to the direction of propagation of the wave. These waves do not require any material medium for propagation and can even travel through vacuum. The speed of light in a material medium (v) depends on the refractive index of the medium (n) which, in turn, depends on permeability and permittivity of the medium. The refractive index is equal to the ratio of the speed of light in vacuum (c) to the speed of light in the medium (v). The refractive index of vacuum is 1 and that of air can be approximated to be 1.

**Do you know?**

It was shown by Einstein in his special theory of relativity that the speed of light (c) does not depend on the velocity of the source of light or the observer. He showed that no object or information can travel faster than the speed of light in vacuum which is 300,000 km/s.

Electromagnetic waves can have wavelengths ranging from very small, smaller than a femtometre (10^{-15} m), to very large, larger than a kilometre. In the order of increasing wavelength, the waves are classified as γ -rays, X-rays, ultraviolet, visible, infrared, microwave and radio waves. Visible light comprises of wavelengths in the 400-700 nm range. Waves of different wavelengths in the visible range are perceived by our eyes as different colours, with violet having the shortest and red having the longest wavelength. White light is a mixture of waves of different wavelengths. The refractive index of a medium depends on the wavelength used. Because of this, for the same angle of incidence, the angle of refraction is different for different colours (except for normal incidence) and therefore the colours present in the white light get separated on passing through a transparent medium. This is the reason for formation of a spectrum and of a rainbow.

7.4 Huygens' Theory:**7.4.1 Primary and Secondary Sources of Light:**

We see several sources of light around us, e.g., the Sun, moon, stars, light bulb, etc. These can be classified into primary and secondary sources of light. *Primary sources* are sources that emit light of their own, because of (i) their high temperature (examples: the Sun, the stars, objects heated to high temperatures, flame of any kind, etc), (ii) the effect of current being passed through them (examples: tube light, TV, etc.), and (iii) chemical or nuclear

reactions (examples: firecrackers, nuclear energy generators). Light originates in these sources.

Secondary sources are those sources which do not produce light of their own but receive light from some other source and either reflect or scatter it around. Examples include the moon, the planets, objects like humans, animals, plants, etc., which we see due to reflected light. Majority of the sources that we see in our daily life are secondary sources. Most secondary sources are extended sources as can be seen from the examples above.

7.4.2 Wavefront:

We have seen that when we drop a stone in water, surface waves, commonly known as ripples, are generated which travel outwards from the point, say O, where the stone touches water. Water particles along the path of the wave move up and down, perpendicular to the water surface. The phase of the wave at a point is defined by the state of motion of the particle at that point as well as the distance of the point from the source (see Chapter 8 in XIth Std book). Two particles are in phase, i.e., have the same phase if their state of motion is the same, i.e., if they have the same velocity and displacement perpendicular to the water surface and if they are at the same distance from the source. As the waves are travelling symmetrically in all directions along the water surface, all particles along the circumference of a circle with centre at O will have the same phase. The locus of all points having the same phase at a given instant of time is called a *wavefront*. Thus, a wavefront is the locus of all points where waves starting simultaneously from O reach at a given instant of time. In case of water waves the wavefronts are circles centred at O. The direction of propagation of the wave is perpendicular to the wavefronts, i.e., along the radii of the circle. The speed with which the wavefronts move is the speed

of the wave. Water waves are two dimensional (along a surface) waves.

Three dimensional waves like the sound waves produced by a source of sound, or light waves produced by a light source, travel in all directions away from the source and propagate in three dimensions. Such a wave is called a *spherical wave*. In these cases, the wavefronts are surfaces passing through all points having the same distance from the source and having the same phase. Thus, in these cases, they are spheres centred on the source say at O, the cross sections of which are as shown in Fig.7.1 (a). The spheres, the crosssections of which are seen as circles in the figure are wavefronts with the source at their centre. The arrows are perpendicular to the spherical surfaces and show the direction of propagation of the waves. These arrows are the rays of light that we have considered in earlier study of optics. The wavefronts shown in the figure correspond to a diverging beam of light. We can similarly have wavefronts corresponding to a converging beam of light. Such wavefronts can be produced after passing through a lens.

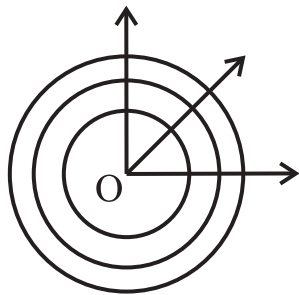

Fig.7.1 (a): Spherical wavefronts corresponding to diverging beam of light. These are spherical waves. The source is at O.

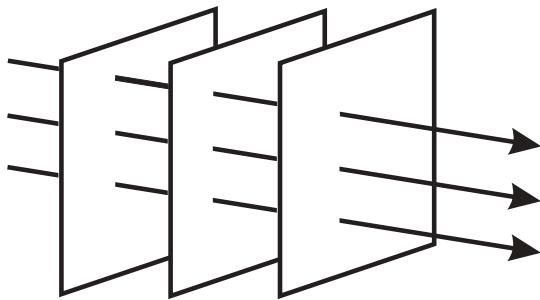

Fig.7.1(b): Plane wavefronts corresponding to parallel beam of light. These are plane waves.

Let us now consider a spherical wavefront which has travelled a large distance away from the source. If we take a small portion this wavefront, it will appear to be a plane surface (just like the surface of the earth around us appears to be flat to us) with the direction of propagation perpendicular to it. In such a case the wave is called a *plane wave*. Wavefronts for a plane wave are shown in Fig.7.1 (b) where the arrows (rays) which are now parallel corresponding to a parallel beam of light, show the direction of propagation of the wave. If the source of light is linear (along a line) the wave fronts will be cylindrical.

7.4.3 Huygens' Principle:

Huygens had assumed light to be a wave, similar to the mechanical wave like the water wave or sound wave, propagating in ether. Accordingly the particles of ether oscillate due to the propagation of a light wave. He put forth a principle which makes it possible to determine the shape of a wavefront at any time t , given its shape at an earlier time. This principle can be stated as “*Each point on a wavefront acts as a secondary source of light emitting secondary light waves called wavelets in all directions which travel with the speed of light in the medium. The new wavefront can be obtained by taking the envelope of these secondary wavelets travelling in the forward direction and is thus, the envelope of the secondary wavelets in forward direction. The wavelets travelling in the backward direction are ineffective*”.

Given a wavefront at time $t = 0$ say, we can determine the shape and position of a wavefront at a later time $t = T$ using Huygens' principle. Let us first consider a plane wavefront AB (corresponding to parallel rays), at time $t = 0$ crosssection of which is shown in Fig.7.2 (a). According to Huygens' principle, each point on this wavefront will act as a secondary source of light and will emit spherical wavelets as shown in the figure. We

have shown only the wavelets travelling in the forward direction (direction of propagation of light) as the backward travelling wavelets are supposed to be ineffective. The wavelets will be in the form of hemispheres and at a later time $t = T$, the radius of the hemispheres will be vT where v is the speed of light. The wavefront at time T will be the envelope of all these hemispherical wavelets and will be a plane $A'B'$ as shown in the figure. Similarly, the position of a spherical wavefront at time $t = 0$ is shown as AB in Fig.7.2 (b). The wavelets emitted in the forward direction by points on AB will be hemispheres as shown in the figure. At time T the radius of these spheres will be vT and their envelope will be a spherical surface $A'B'$ as shown.

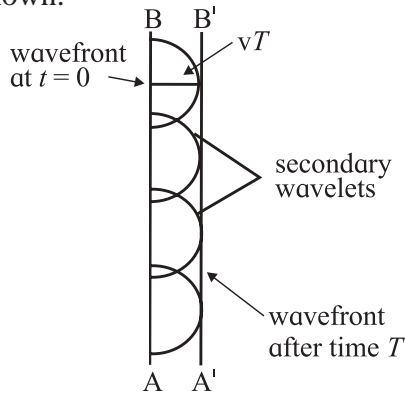

Fig.7.2 (a): Progress of a plane wavefront.

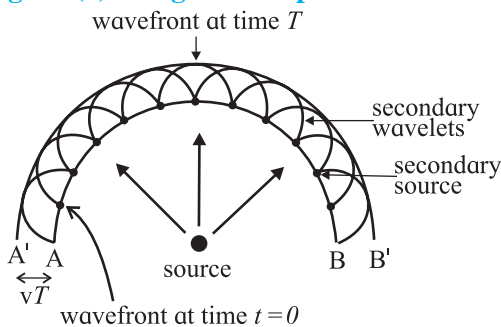

Fig.7.2 (b): Progress of a spherical wavefront.

Huygens' theory is an empirical theory. There is no reason why the backward travelling waves will not be effective. The theory was accepted just because it explained various optical phenomena as we will see next.

7.5 Reflection of Light at a Plane Surface

Let us consider a plane wavefront AB perpendicular to the plane of the paper, incident at an angle i with the normal to a

plane reflecting surface (mirror) MN which is also perpendicular to the plane of the paper as shown in Fig.7.3. The figure shows a cross section of the setup. RA and QB show the direction of incidence. Let us assume that the incident wavefront AB touches the reflecting surface at A at time $t = 0$. The point B will touch the reflecting surface at C after a time $t = T$. Between time $t = 0$ and T , different points along the incident wavefront reach the reflecting surface successively and secondary wavelets will start propagating in the form of hemispheres from those points in succession. For reflection, the hemispheres to be considered are on the same side of the mirror. The wavelet emitted by point A will have a radius vT at time T . The radius of the wavelet emitted by C will be zero at that time. The radii of the wavelets emitted by points between A and C will gradually decrease from vT to 0 . The envelope of these wavelets forms the reflected wavefront. This is shown by EC which is the common tangent to the reflected wavelet originating from A and other secondary wavelets emitted by points between A and C .

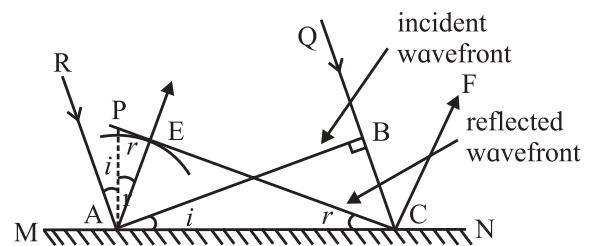

Fig.7.3: Reflection at a plane surface.

Obviously, $AE = BC = vT$, the distance travelled by light in the same medium in same time. The arrow AE shows the direction of propagation of the reflected wave. The normal to MN at A is shown by AP , the angle of incidence $\angle RAP = i$. As RA and AP are perpendicular to AB and AC respectively, $\angle BAC$ is also equal to i . The triangles ABC and AEC are right angled triangles and have common hypotenuse (AC) and one equal side ($AE = BC$). Hence, the two triangles are congruent and we have,

$$\angle ACE = \angle BAC = i. \quad \text{--- (7.1)}$$

The angle of reflection is $\angle PAE = r$. As AE is perpendicular to CE and AP is perpendicular to AC,

$$\angle ACE = \angle PAE = r. \quad \text{--- (7.2)}$$

Eqs. (7.1) and (7.2) give us $i = r$ which is the law of reflection.

It is also clear from the figure that the incident ray, normal and the reflected ray are in the same plane which is the plane of the paper. This is the other law of reflection.

Let us assume the rays, RA and QC to be coming from the extremities of the object, i.e., AB is the size of the object. The distance between the corresponding reflected rays AE and CF will be same as AB as can be seen from the congruent triangles, ABC and AEC. Thus, the size of the object in the reflected image will be same as the actual size of the object.

Let us assume A and B to be the right and left sides of the object respectively as it looks into the mirror. After reflection, the right side, at A is seen at E and the left side at B is seen at C. As the right side has now become left side and vice-versa as the image comes out of the mirror. This is called lateral inversion. Below we will see that lateral inversion does not occur during refraction at a plane surface.

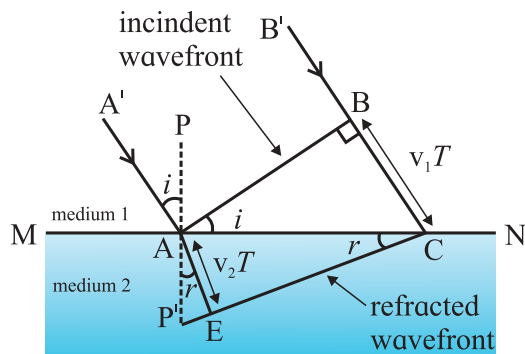

Fig.7.4: Refraction of light.

7.6. Refraction of Light at a Plane Boundary Between Two Media :

Consider a wavefront AB, incident on a plane boundary MN, separating two uniform and optically transparent media as shown in Fig 7.4. At time $t = 0$, A has just reached the boundary surface, while B reaches the surface

at C at a later time $t = T$. Let the speed of light be v_1 in medium 1 and v_2 in medium 2. Thus, $BC = v_1 T$. At time $t = T$, the radius (AE) of the secondary wavelet emitted from A will be $v_2 T$. The refracted wavefront will be the envelope of wavelets successively emitted by all the points between A and C between time $t = 0$ and $t = T$. CE is the tangent to the secondary wavelet emitted from A. It is also the common tangent to all the secondary wavelets emitted by points between A and C. The normal to the boundary at A is shown by PP'.

$$\angle A'AP = \angle BAC = \text{the angle of incidence} = i$$

$$\angle P'AE = \angle ACE = \text{angle of refraction} = r$$

From $\triangle ABC$,

$$\sin i = v_1 T / AC \quad \text{--- (7.3)}$$

From $\triangle AEC$,

$$\sin r = v_2 T / AC \quad \text{--- (7.4)}$$

From Eqs. (7.3) and (7.4) we get

$$\sin i / \sin r = v_1 / v_2 = (c/v_2) / (c/v_1) = n_2 / n_1,$$

$$n_1 \sin i = n_2 \sin r, \quad \text{--- (7.5)}$$

Here, n_1 and n_2 are the absolute refractive indices of media 1 and 2 respectively. Eq. (7.5) is the law of refraction and is also called the Snell's law. Also, it is clear from the figure that the incident and refracted rays and the normal to the boundary surface are in the same plane. If $v_1 > v_2$, i.e., $n_1 < n_2$. Then $i > r$. Thus, during oblique incidence, the refracted ray will bend towards the normal while going from an optically rarer (smaller refractive index) to an optically denser (higher refractive index) medium. While entering an optically rarer medium from a denser medium, the refracted ray will bend away from the normal.

The refracted image will not be inverted as can be seen from the diagram. Also, except for normal incidence, the image seems to be bent (broken) below the boundary surface as the rays change their direction on crossing the surface. At normal incidence, the rays travel along the same direction and there is no breaking of the image.

Dependence of Wavelength on the Refractive Index of the Medium:

Consider monochromatic light incident normally on a boundary between a rarer medium and a denser medium as shown in Fig. 7.5 (a). The boundary between the two surfaces is shown by PQ. The three successive wavefronts AB, CD and EF are separated by a distance λ_1 , which is the wavelength of light in the first medium. After refraction, the three wavefronts are indicated by A'B', C'D' and E'F'. Assuming the second medium to be denser, the speed of light will be smaller in that medium and hence, the wavefronts will move slower and will be able to cover less distance than that covered in the same time in the first medium. They will therefore be more closely spaced than in the first medium. The distance between any two wavefronts is λ_2 , equal to the wavelength of light in the second medium. Thus, λ_2 will be smaller than the wavelength in the first medium. We can easily find the relation between λ_1 and λ_2 as follows.

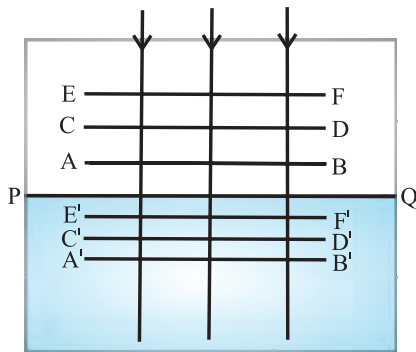

Fig.7.5 (a): Change in wavelength of light while going from one medium to another for normal incidence.

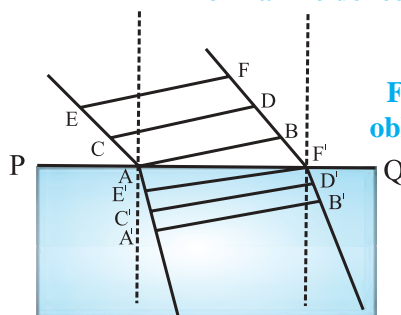

Fig.7.5 (b): For oblique incidence.

Let the wavefront AB reach the boundary surface PQ at time $t = 0$ and the next wavefront

CD which is at a distance of λ_1 from AB, reach PQ at time $t = T$. As the speed of the wave is v_1 in medium 1 and T is the time period in which the distance λ is covered by the wavefront, we can write

$$T = \lambda_1/v_1 \quad \text{--- (7.6)}$$

In medium 2, the distance travelled by the wavefront in time T will be λ_2 . The relation between these two quantities will be given by

$$T = \lambda_2/v_2 \quad \text{--- (7.7)}$$

Eq. (7.6) and Eq. (7.7) show that the velocity in a medium is proportional to the wavelength in that medium and give

$$\lambda_2 = \lambda_1 v_2/v_1 = \lambda_1 n_1/n_2 \quad \text{--- (7.8)}$$

If medium 1 is vacuum where the wavelength of light is λ_0 and n is the refractive index of medium 2, then the wavelength of light in medium 2, λ can be written as

$$\lambda = \lambda_0 v_2/c = \lambda_0/n \quad \text{--- (7.9)}$$

The ratio of the frequencies v_1 and v_2 , of the wave in the two media can be written, using Eq. (7.8) as,

$$v_1 / v_2 = (v_1/ \lambda_1)/(v_2/ \lambda_2) = 1 \quad \text{--- (7.10)}$$

This demonstrates that the frequency of a wave remains unchanged while going from one medium to another. Similar analysis goes through if the wave is incident at an angle as shown in Fig.7.5 (b).



Remember this

The frequency of a wave is its fundamental property and does not change while going from one medium to another. The speed and the wavelength of a wave do change and are inversely proportional to the relative refractive index of the second medium with respect to the first.

7.7 Polarization:

We know that light is an electromagnetic wave and that its electric (E) and magnetic (B) field vectors are perpendicular to each other and to the direction of propagation. We also know that light is emitted by atoms. Thus, when one atom emits a wave along the x -axis

say, its electric field may be along the y -axis and magnetic field will be along the z -axis. However, if another atom in the source emits a wave travelling along the x -axis, it is not necessary that the electric field be along the y -axis. It can be along any direction in the y - z plane and the magnetic field will be along a direction perpendicular to it. Thus, in general, the electric fields of waves emitted along the x -axis by a light source like the Sun, stars or a light bulb will be in all possible directions in the y - z plane and the corresponding magnetic fields will be perpendicular to their electric fields. Such light is called *unpolarized* light and is represented by double headed arrows (showing the directions of electric field) in a plane perpendicular to the direction of propagation. This is shown in Fig.7.6 (a) for a light beam travelling perpendicular to the plane of the paper. On the other hand, if somehow light is constrained so that its electric field is restricted along one particular direction, then it is called *plane polarized* light. This is shown in Fig.7.6 (b) for a light beam travelling perpendicular to the plane of the paper.

How can we get polarized light? There are certain types of materials which allow only

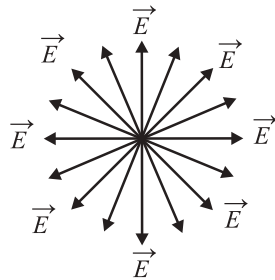

Fig. 7.6 (a): Unpolarized light coming towards us or going away from us.



Fig. 7.6 (b): Polarized light coming towards us or going away from us with electric field along the horizontal direction.

those light waves which have their electric field along a particular direction to pass through and block all other waves which have their electric field in other directions. These materials are called polarizers. A polaroid is a kind of synthetic plastic sheet which is

used as polarizer. The particular direction along which the electric field of the emergent wave is oriented is called the polarizing axis of the polarizer. This is shown in Fig.7.7 (a). Thus, when unpolarized light passes through a polarizer, the emergent light is plane polarized. The plane ABCD containing the electric field vector of plane polarized light is called the *plane of vibration* while the plane perpendicular to the plane of the vibration (horizontal plane) is called *plane of polarization*.

If the polarized light is made to pass through another polarizer with its polarizing axis perpendicular to the polarizing axis of the first polarizer, no light can emerge on the other side as the second polarizer would allow only waves having electric field parallel to its polarizing axis to pass through. On the other hand, if the polarizing axis of the second polarizer makes an angle smaller than 90° with that of the first polarizer, then the component of the electric field of the polarized light along the direction of the polarizing axis of the second polarizer can pass through. The intensity of light will reduce after passing through each polarizer. We will mathematically calculate this below. We have used the electric field to explain the phenomenon of polarization, however, it could also be explained in the same manner using the magnetic field.

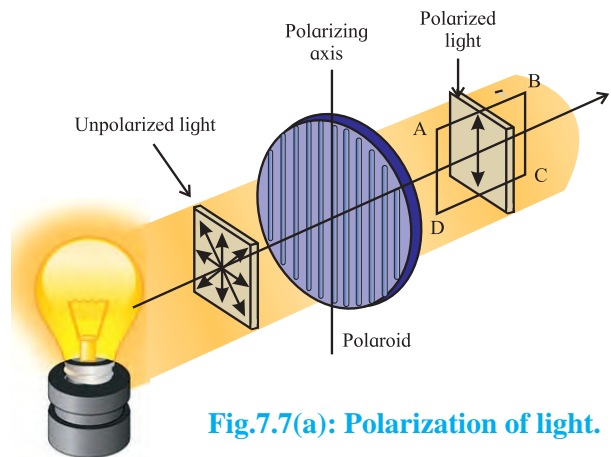

Fig.7.7(a): Polarization of light.

Consider an unpolarized wave having angular frequency ω and wave vector k ($=2\pi/\lambda$), travelling along the x -direction. The magnitude of its electric field is given by $E = E_0 \sin(kx - \omega t)$, E_0 being the amplitude of

the wave (see Chapter 13 of the XIth Std book). The intensity of the wave will be proportional to $|E_0|^2$. The direction of the electric field can be anywhere in the y - z plane we will consider the passage of this wave through two polarizers as shown in Fig. 7.7 (b). Let us consider a particular wave having its electric field at an angle ϕ to the axis of the first polarizer. The component $E_0 \cos \phi$ will pass through the first polarizer while the normal component $E_0 \sin \phi$ will be obstructed. The intensity of this particular wave after passing through the polarizer will be proportional to the square of its amplitude, i.e., to $|E_0 \cos \phi|^2$. For unpolarized incident wave, ϕ can have all values from 0 to 180° . Thus, to get the intensity of the plane polarized wave emerging from the first polarizer, we have to average $|E_0 \cos \phi|^2$ over all values of ϕ between 0 and 180° . The value of the average of $\cos^2 \phi$ is $\frac{1}{2}$. Hence, the intensity of the wave will be proportional

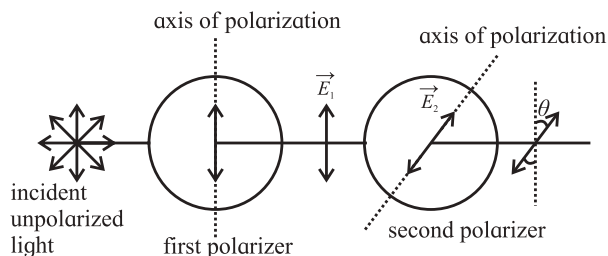

Fig.7.7(b): Unpolarized light passing through two polarizers.

to $\frac{1}{2}|E_0|^2$, i.e., the intensity of an unpolarized wave reduces by half after passing through a polarizer.

Let us now consider the linearly polarized wave emerging from first polarizer. Let us assume that the polarized wave has its electric field (\vec{E}_1) along the y -direction as shown in the figure. We can write the electric field as

$$\vec{E}_1 = \hat{j}E_{10} \sin(kx - \omega t), \quad \text{--- (7.11)}$$

where, E_{10} is the amplitude of this polarized wave. The intensity of the polarized wave is given by

$$I_1 \propto |E_{10}|^2 \quad \text{--- (7.12)}$$

Now if this wave passes through second polarizer whose polarization axis makes an angle θ with the y -direction, only the component $E_{10} \cos \theta$ will pass through. Thus, the amplitude of the wave which passes through (say E_{20}) is now $E_{10} \cos \theta$ and its intensity I_2 will be

$$I_2 \propto |E_{20}|^2 \\ I_2 \propto |E_{10}|^2 \cos^2 \theta, \text{ or } I_2 = I_1 \cos^2 \theta. \quad \text{--- (7.13)}$$

This is known as *Malus' law* after E. L. Malus (1775-1812) who discovered the law experimentally. *Malus' law gives the intensity of a linearly polarized wave after it passes through a polarizer.*

Note that θ is the angle between the axes of polarization of the two polarizers. If θ is equal to zero, i.e., the polarization axes of the two polarizers are parallel, the intensity does not change while passing through the second polarizer. If θ is 90° , $\cos^2 \theta$ is 0 and no light emerges from the second polarizer. $\theta = 0^\circ$ and 90° are known as parallel and cross settings of the two polarizers.



Remember this

Only transverse waves can be polarized while longitudinal waves cannot be polarized. In transverse waves, the oscillations can be along any direction in a plane which is perpendicular to the direction of propagation of the wave. By restricting the oscillations to be along only one direction in this plane, we get a plane polarized wave. For longitudinal waves, e.g., the sound wave, the particles of the medium oscillate only along one direction, which is the direction of propagation of the wave, so there is nothing to restrict.

Example 7.1: Unpolarized light of intensity I_0 , is made to pass through three polarizers P_1 , P_2 and P_3 successively. The polarization axis of P_2 makes an angle of θ_1 with that of P_1 , while that of P_3 makes an angle θ_2 with that of the P_2 . What will be the intensity of

light coming out of P_3 ?

Solution: The first polarizer, P_1 will polarize the incident unpolarized light. The intensity after passing through this polarizer will be $I_1 = I_0/2$ as discussed above. Let us assume that the amplitude of the electric field after passing through P_1 is E_{10} . While passing through P_2 , a component of the electric field, $E_{20} = E_{10} \cos \theta_1$ will be able to pass through. Thus, the intensity of light coming out of P_2 will be $I_2 = (I_1 \cos^2 \theta_1) = (I_0 \cos^2 \theta_1)/2$. While passing through P_3 , a component $E_{30} = E_{20} \cos \theta_2$ will pass through. Thus, the intensity of light coming out of P_3 will be $I_3 = (I_0 \cos^2 \theta_1 \cos^2 \theta_2)/2$

7.7.1 Polarization by Reflection: Brewster's

Law:

When light is incident at an angle on a boundary between two transparent media having refractive indices n_1 and n_2 , part of it gets refracted and the rest gets reflected. Let us consider unpolarized light incident from medium of refractive index n_1 on such a boundary perpendicular to the plane of the paper, as shown in Fig.7.8.

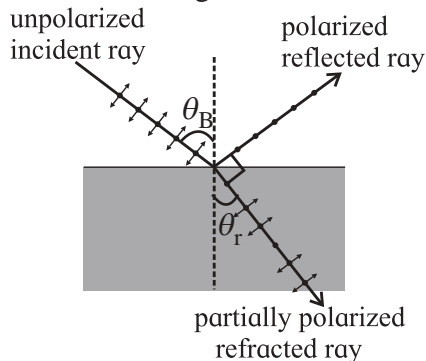

Fig. 7.8: Polarization by reflection.

The incident wave is unpolarized. Its electric field which is in the plane perpendicular to the direction of incidence, is resolved into two components, one parallel to the plane of the paper, shown by double arrows and the other perpendicular to the plane of the paper shown by dots. Both have equal magnitude. In general, the reflected and refracted rays do not have equal magnitudes of the two components

and hence are partially polarized. It was experimentally discovered by D. Brewster in 1812 that for a particular angle of incidence θ_B (shown in the figure), the reflected wave is completely plane polarized with its electric field perpendicular to the plane of the paper while the refracted wave is partially polarized. This particular angle of incidence is called the Brewster's angle. For this angle of incidence, the refracted and reflected rays are perpendicular to each other. From the figure, for angle of refraction θ_r we have,

$$\theta_B + \theta_r = 90^\circ \quad \text{--- (7.14)}$$

From law of refraction we have,

$$n_1 \sin \theta_B = n_2 \sin \theta_r. \text{ This with Eq.(7.14) gives}$$

$$n_1 \sin \theta_B = n_2 \sin(90 - \theta_B), \text{ giving}$$

$$\frac{n_2}{n_1} = \tan \theta_B, \text{ or}$$

$$\theta_B = \tan^{-1}\left(\frac{n_2}{n_1}\right) \quad \text{--- (7.15)}$$

This is known as *Brewster's law*.

The phenomena of polarization by reflection is used to cut out glare from the reflecting surfaces using special sunglasses. Sunglasses are fitted with polaroids which reduce the intensity of the partially or fully polarized reflected light coming to the eyes from reflecting surfaces. As seen above, the intensity of Sunlight or light coming from artificial sources which is completely unpolarized is also reduced to half by the polaroid. This phenomenon of polarization by reflection works only for nonmetallic surfaces.



Use your brain power

What will you observe if

1. you look at an unpolarized source of light through a polarizer?
2. you look at the source through two polarizers and rotate one of them around the path of light for one full rotation?
3. instead of rotating only one of the polaroid, you rotate both polaroids simultaneously in the same direction?

Example 7.2: For what angle of incidence will light incident on a bucket filled with liquid having refractive index 1.5 be completely polarized after reflection?

Solution: The reflected light will be completely polarized when the angle of incidence is equal to the Brewster's angle which is given by $\theta_B = \tan^{-1} \frac{n_2}{n_1}$, where n_1 and n_2 are refractive indices of the first and the second medium respectively. In this case, $n_1 = 1$ and $n_2 = 1.5$.

Thus, the required angle of incidence = Brewster's angle = $\tan^{-1} \frac{1.5}{1} = 56.31^\circ$

7.7.2 Polarization by Scattering:

When Sunlight strikes air molecules or dust particles in the atmosphere, it changes its direction. This is called scattering. We see the sky as blue because of this scattering as blue light is preferentially scattered. If there were no scattering, the sky would appear dark to us as long as we do not directly look at the Sun and we could see stars even during the day. When Sunlight is scattered, it gets partially polarized in a way similar to the reflected light seen above (Fig. 7.8). The degree of polarization depends on the angle of scattering, i.e., the angle between the direction of the light incident on the molecule or dust particle and the direction of the scattered light. If this angle is 90° , the scattered light is plane polarized. Thus, the scattered light reaching us from different directions in the sky is polarized to different degrees.



Can you tell?

1. If you look at the sky in a particular direction through a polaroid and rotate the polaroid around that direction what will you see?
2. Why does the sky appear to be blue while the clouds appear white?

7.8 Interference:

We have learnt about the superposition of waves in Chapter 6. According to this principle, when two or more waves overlap, the resultant displacement of a particle of the medium, at a given point is the sum of the displacements of the particle produced by individual waves, as if each wave is the only one which is present. Because of this, particles in the medium present where the crests (or troughs) of the two waves coincide will have larger displacements, while particles present where the crest of one wave coincides with the trough of the other, the displacement will be minimum. If the amplitudes of the two waves are equal, then for the first set of particles, the displacement will be twice the amplitude of the individual wave, and for the second set of particles, the displacement will be zero. Thus, the intensity of the wave which is proportional to the square of the amplitude of the wave, will be nonuniform, being larger at some places and smaller at others. This is called *interference*.

Interference is shown in Fig.7.9 for water waves. S_1 and S_2 are sources of water waves of the same wavelength and amplitude, and are in phase with each other, i.e., at any given instant of time, the phases of the waves emitted by both sources are equal. The crests are shown by continuous circles while the troughs are shown by dashed circles. Points where the crest of one wave coincides with the crest of another wave and where the trough of one wave coincides with the trough of another wave are shown by blue dots. At these points the displacement is maximum and is twice that for each wave. These are points of *constructive interference*. The points where the crest of one wave is coincident with the trough of another are shown by red dots. At these points, the displacement is zero. These are points of *destructive interference*. Thus, along some straight lines radially diverging from the

midpoint of S_1S_2 , there is constructive (along the radial lines connecting the blue dots) and destructive (along the radial lines connecting the red dots) interference. Interference had been observed in the case of water waves and sound waves. It was observed for light waves in the laboratory for the first time by Thomas Young (1773-1829) in the year 1801. As noted above, this was the first proof of the wave nature of light. We will discuss this below.

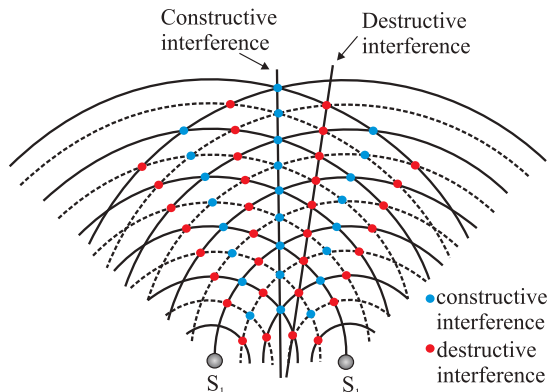

Fig.7.9: Interference for water waves.

7.8.1 Coherent Sources of Light:

Two sources which emit waves of the same frequency having a constant phase difference, independent of time, are called coherent sources. At any given point in space, at every instant of time, there are light waves from multiple sources overlapping one another. These must be interfering and we should be able to see interference all around us at all time. However, we see no interference pattern. This is because different sources emit waves of different frequencies and even if they emit waves of the same frequency, they are not in phase. Thus, the interference pattern changes every instant of time and no pattern is sustained over a significant length of time for us to see.

For interference to be seen over sustained periods, we need two sources of light which emit waves of the same frequency and the waves emitted by them are in phase or have a constant phase difference between them, i.e. we need coherent sources of light.

This criterion cannot be satisfied by two independent primary sources as they emit waves independently and there need not be a constant phase relation between them. Thus, to obtain sustained interference pattern one usually obtains two secondary sources from the same primary source as is done in Young's double slit experiment below.

7.8.2 Young's Double Slit Experiment:

In this experiment, a plane wavefront is made to fall on an opaque screen AB having two similar narrow slits S_1 and S_2 . The plane wavefront can be either obtained by placing a linear source S far away from the screen or by placing it at the focus of a convex lens kept close to AB. The rays coming out of the lens will be parallel rays and the wavefront will be a plane wave front as shown in Fig.7.10. The figure shows a cross section of the experimental set up and the slits have their lengths perpendicular to the plane of the paper. For better results, the slits should be about 2-4 mm apart from each other. An observing screen PQ is placed behind of AB. For simplicity we assume that the slits S_1 and S_2 are equidistant from the S so that the wavefronts starting from S and reaching the S_1 and S_2 at every instant of time are in phase.

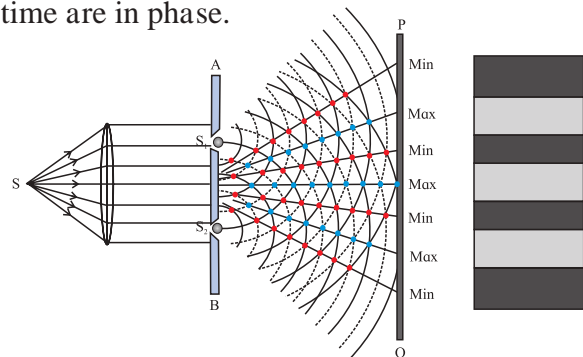

Fig. 7.10: Young's double slit experiment.

When the rays fall on S_1 and S_2 , the two slits act as secondary sources of light emitting cylindrical wavelets (with axis along the slit length) to the right of AB. The two secondary sources emit waves in phase with each other at all times (as the waves falling on them are in phase coming from a plane wavefront).

The crests/troughs of the secondary wavelets superpose as shown in the figure and interfere constructively along straight lines joining the blue dots as shown. The point where these lines meet the screen have high intensity and are bright. The images of the slits are also perpendicular to the plane of the paper. The image plane, rotated through 90° is shown on the right side of the figure. Midway between these lines are lines joining the red dots along which the crest of one wave coincides with the trough of the other causing zero intensity and producing dark images of the slits on the screen PQ. These are the dark regions on the screen as shown on the right. The dark and bright regions are called fringes and the whole pattern is called interference pattern.

Let us now determine the positions and intensities of the fringes mathematically. Let us take the direction of propagation of the plane waves incident on AB as x -axis. The screen is along the y - z plane, y -axis being along the plane of the paper. The origin of the axes can be taken to be O, the central point of $S_1 S_2$ as shown in Fig.7.11 which shows the x - y cross section of the experimental setup. Let the distance between the two slits S_1 and S_2 be d and that between O and O' be D . For better results D should be about a metre for the slit separation mentioned above.

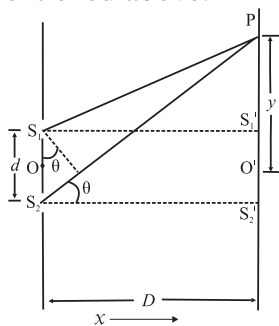

Fig.7.11: Geometry of the double slit experiment.

The point O' on the screen is equidistant from S_1 and S_2 . Thus, the distances travelled by the wavelets starting from S_1 and S_2 to reach O' will be equal. The two waves will be in phase at O' , resulting in constructive interference. Thus, there will be a bright spot at O' and a bright fringe at the centre of the screen, perpendicular

to the plane of the paper as shown at the right in the Fig. 7.10.

Now let us determine the positions of other bright fringes on the screen. Consider any point P on the screen. The two wavelets from S_1 and S_2 travel different distances to reach P and so the phases of the waves reaching P will not be the same. If the path difference (Δl) between $S_1 P$ and $S_2 P$ is an integral multiple of λ , the two waves arriving there will interfere constructively producing a bright fringe at P. If the path difference between $S_1 P$ and $S_2 P$ is half integral multiple of λ , there will be destructive interference and a dark fringe will be located at P.

Considering triangles $S_1 S_1' P$ and $S_2 S_2' P$, we can write

$$\begin{aligned} (S_2 P)^2 - (S_1 P)^2 &= \left\{ D^2 + \left(y + \frac{d}{2} \right)^2 \right\} - \left\{ D^2 + \left(y - \frac{d}{2} \right)^2 \right\} \\ &= 2 y d, \text{ giving,} \end{aligned}$$

$$S_2 P - S_1 P = \Delta l = 2 y d / (S_2 P + S_1 P),$$

For $d/D \ll 1$, we can write $S_2 P + S_1 P \approx 2 D$, giving

$$\Delta l = 2 \frac{y d}{2 D} = y \frac{d}{D}$$

Thus, the condition for constructive interference at P can be written as

$$\Delta l = y_n \frac{d}{D} = n \lambda. \quad \text{--- (7.16)}$$

y_n being the position (y -coordinate) of n^{th} bright fringe ($n = 0, \pm 1, \pm 2, \dots$). It is given by

$$y_n = n \lambda D/d. \quad \text{--- (7.17)}$$

Similarly, the position of n^{th} ($n = \pm 1, \pm 2, \dots$) dark fringe (destructive interference) is given by

$$S_2 P - S_1 P = \Delta l = y_n \frac{d}{D} = \left(n - \frac{1}{2} \right) \lambda, \text{ giving}$$

$$y_n = (n - 1/2) \lambda D/d. \quad \text{--- (7.18)}$$

The distance between any two successive dark or any two successive bright fringes ($y_{n+1} - y_n$) is equal. This is called the *fringe width* and is given by,

$$\text{Fringe width} = W = \Delta y = y_{n+1} - y_n$$

$$W = \lambda D/d \quad \text{--- (7.19)}$$

Thus, both dark and bright fringes are equidistant and have equal widths.

We can also write Eq.(7.16) to Eq.(7.19) in terms of phase difference between the two waves as follows.

The relation between path difference (Δl) and phase difference $\Delta\phi$ is given by,

$$\Delta\phi = \left(\frac{2\pi}{\lambda}\right) \Delta l \quad \text{--- (7.20)}$$

Thus, the phase difference between the two waves reaching P, from S_1 and S_2 is given by,

$$\Delta\phi = y \frac{d}{D} \left(\frac{2\pi}{\lambda}\right). \quad \text{--- (7.21)}$$

The condition for constructive interference in terms of phase difference is given by

$$\Delta\phi_n = n2\pi, \quad n = 0, \pm 1, \pm 2, \dots \text{---(7.22)}$$

The condition for destructive interference in terms of phase difference is given by

$$\Delta\phi_n = \left(n - \frac{1}{2}\right)2\pi, \quad n = \pm 1, \pm 2, \dots \text{---(7.23)}$$



Remember this

- For the interference pattern to be clearly visible on the screen, the distance (D) between the slits and the screen should be much larger than the distance (d) between two slits, i.e., $D \gg d$. We have already used this condition while deriving Eq.(7.16).
- Conditions given by Eq.(7.16-7.19) and hence the locations of the fringes are derived assuming that the two sources S_1 and S_2 are in phase. If there is a nonzero phase difference between them it should be added appropriately. This will shift the entire fringe pattern but will not change the fringe widths.

Intensity distribution:

As there is constructive interference at the centre of a bright fringe, the amplitude of the wave is twice that of the original wave incident on AB and the intensity, I , being proportional to the square of the amplitude, is four times the intensity of the incident wave I_0 say. At the

centres of the dark fringes, the intensity is zero. At in between points, the intensity gradually changes from zero to $4I_0$ and vice versa.

Thus, the interference fringes are equally bright and equally spaced. This is however, valid only in the limit of vanishing widths of the slits. For wide slits, the waves reaching a given point on the screen from different points along a single slit differ in path lengths travelled and the intensity pattern changes resulting in a blurred interference pattern with poor contrast.

We can calculate the intensity at a point P on the screen where the phase difference between the two waves is ϕ , as follows.

We can write the equations of the two waves coming from S_1 and S_2 , at the point P on the screen as

$$E_1 = E_0 \sin \omega t \quad \text{and} \quad E_2 = E_0 \sin (\omega t + \phi)$$

The incident intensity $I_0 = |E_0|^2$

The resultant electric field at P will be given by $E = E_0 \sin \omega t + E_0 \sin (\omega t + \phi) = 2 E_0 \cos (\phi / 2) \sin (\omega t + \phi / 2)$. The amplitude of the wave is $2 E_0 \cos (\phi / 2)$.

Thus, the intensity at P will be proportional to $|2 E_0 \cos (\phi / 2)|^2$ and it will be equal to $4I_0 \cos^2 (\phi / 2)$.

Let us consider the case when the amplitudes of the waves coming from the two slits are different, E_{10} and E_{20} , say. In this case, the intensities of the bright and dark bands will be different from what is discussed above. At the centre of the bright fringes, the amplitude will be $E_{10} + E_{20}$ and hence the intensity will be proportional to $|E_{10} + E_{20}|^2$, while at the centres of the dark fringes, the intensities will not be zero but will be proportional to $|E_{10} - E_{20}|^2$.

7.8.3 Conditions for Obtaining Well Defined and Steady Interference Pattern:

The following conditions have to be satisfied for the interference pattern to be steady and clearly visible. Some of these have already been mentioned above. However, we list them all here for completeness.

1. The two sources of light should be coherent. This is the essential condition for getting sustained interference pattern. As we have seen, the waves emitted by two coherent sources are always in phase or have a constant phase difference between them at all times. If the phases and phase difference vary with time, the positions of maxima and minima will also change with time and the interference pattern will not be steady. For this reason, it is preferred that the two secondary sources used in the interference experiment are derived from a single original source as was shown in Fig.7.10.

Example 7.3: Plane wavefront of light of wavelength 5500 \AA is incident on two slits in a screen perpendicular to the direction of light rays. If the total separation of 10 bright fringes on a screen 2 m away is 2 cm, find the distance between the slits.

Solution: Given: $\lambda = 5500 \text{ \AA}$, $D = 2 \text{ m}$ and
Distance between 10 fringes = 2 cm
= 0.02 m.

The fringe width $W = \lambda D/d = 0.02/10$
= 0.002 m

$$\therefore d = 5500 \times 10^{-10} \times 2 / 0.002$$

$$= 5.5 \times 10^{-4} \text{ m} = 0.055 \text{ cm}$$

Example 7.4: In a Young's double slit experiment, the difference in optical path lengths between the rays starting from the two slits S_1 and S_2 and reaching a point A on the screen is 0.0075 mm and reaching another point B on the screen on the other side of the central fringe is 0.0015 mm. How many bright and dark fringes are observed between A and B if the wavelength of light used is 6000 \AA ?

Solution: The path difference at a point P on the screen at a distance y from the centre is given by $\Delta l = y \frac{d}{D}$,
where d and D are the distances between

the slits and between the wall containing the slits and the screen respectively. Thus, we are given,

$$\Delta l_A = y_A \frac{d}{D} = 0.0075 \text{ mm and } \Delta l_B = y_B \frac{d}{D} = 0.0015 \text{ mm, giving}$$

$y_A = 0.0075 D/d$ and $y_B = 0.0015 D/d$ mm
Here, y_A and y_B are the distances of points A and B from the centre of the screen.

Thus, the distance between the points A and B is $y_A + y_B = 0.009 D/d$ mm.

The width of a bright or dark fringe (i.e., the distance between two bright or two dark fringes) is given by $W = \lambda D/d$. Thus, there will be $(0.009 D/d)/W = 0.009/\lambda = 0.009/(6000 \times 10^{-7}) = 15$ bright fringes between A and B (including the central one) and 14 dark fringes in between the bright fringes.

Alternate solution:

$$\left(\frac{\text{path difference}}{\lambda} \right)_A = \frac{75 \times 10^{-7} \text{ m}}{6 \times 10^{-7} \text{ m}} = 12.5$$

$$\therefore (\text{path difference})_A = 12.5\lambda = \left(13 - \frac{1}{2} \right) \lambda$$

Thus, point A is at the centre of 13th dark band on one side.

Similarly,

$$(\text{path difference})_B = \frac{15}{6} \lambda = 2.5\lambda = \left(3 - \frac{1}{2} \right) \lambda$$

Thus, point B is at the centre of the 3rd dark band on the other side.

Thus, between A and B there will be $12 + 2 + \text{central bright} = 15$ bright bands.

Also excluding the bands at A and B, there will be $12 + 2 = 14$ dark bands between A and B.



Do you know?

Several phenomena that we come across in our day to day life are caused by interference and diffraction of light. These are the vigorous colours of soap bubbles as well as those seen in a thin oil film on the surface of

water, the bright colours of butterflies and peacocks etc. Most of these colours are not due to pigments which absorb specific colours but are due to interference of light

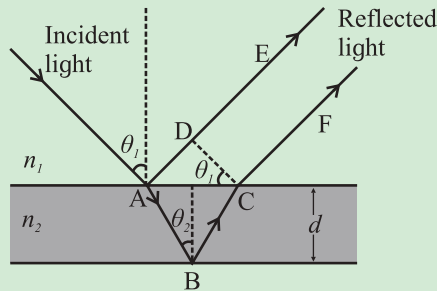

waves that are reflected by different layers.

Interference due to thin films:

The brilliant colours of soap bubbles and thin oil films on the surface of water are due to the interference of light waves reflected from the upper and lower surfaces of the film. The two rays have a path difference which depends on the point on the film that is being viewed. This is shown in the figure.

The incident wave gets partially reflected from upper surface as shown by ray AE. The rest of the light gets refracted and travels along AB. At B it again gets partially reflected and travels along BC. At C it refracts into air and travels along CF. The parallel rays AE and CF have a phase difference due to their different path lengths in different media. As can be seen from the figure, the phase difference depends on the angle of incidence θ_1 , i.e., the angle of incidence at the top surface, which is the angle of viewing, and also on the wavelength of the light as the refractive index of the material of the thin film depends on it. The two rays AE and CF interfere, producing maxima and minima for different colours at different angles of viewing. One sees different colours when the film is viewed at different angles.

As the reflection is from the denser boundary, there is an additional phase difference of π radians (or an additional path difference $\lambda/2$). This should be taken into account for mathematical analysis.

2. **The two sources of light must be monochromatic.** As can be seen from the condition for bright and dark fringes, the position of these fringes as well as the width of the fringes (Eq. (7.17), (7.18) and (7.19)) depend on the wavelength of light and the fringes of different colours are not coincident. The resultant pattern contains coloured, overlapping bands. (In fact, original Young's experiment was with pin holes (not slits) and for sunlight, producing coloured interference pattern with central point as white).
3. **The two interfering waves must have the same amplitude.** Only if the amplitudes are equal, the intensity of dark fringes (destructive interference) is zero and the contrast between bright and dark fringes will be maximum.
4. **The separation between the two slits must be small in comparison to the distance between the plane containing the slits and the observing screen.** This is necessary as only in this case, the width of the fringes will be sufficiently large to be measurable (see Eq.(7.19)) and the fringes are well separated and can be clearly seen.
5. **The two slits should be narrow.** If the slits are broad, the distances from different points along the slit to a given point on the screen are significantly different and therefore, the waves coming through the same slit will interfere among themselves, causing blurring of the interference pattern.
6. **The two waves should be in the same state of polarization.** This is necessary only if polarized light is used for the experiment. The explanation of this condition is beyond the scope of this book.

7.8.4 Methods for Obtaining Coherent Sources:

In Young's double slit experiment, we obtained two coherent sources by making the

light from a single source pass through two narrow slits. There are other ways to get two coherent sources. We will discuss some of those here.

i) Lloyd's mirror: This is an extensively used device. The light from a source is made to fall at a grazing angle on a plane mirror as shown in Fig.7.12. Some of the light falls directly on the screen as shown by the blue lines in the figure and some light falls after reflection, as shown by red lines. The reflected light appears to come from a virtual source and so we get two sources. They are derived from a single source and hence are coherent. They interfere and an interference pattern is obtained as shown in the figure. Note that even though we have shown the direct and reflected rays by blue and red lines, the light is monochromatic having a single wavelength.

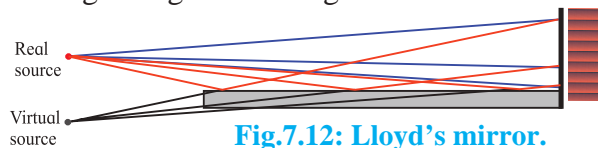

Fig.7.12: Lloyd's mirror.

ii) Fresnel biprism: A biprism is a prism with vertex angle of nearly 180°. It can be considered to be made up of two prisms with very small refracting angle ranging from 30' to 1°, joined at their bases. In experimental arrangement, the refracting edge of the biprism is kept parallel to the length of the slit. Monochromatic light from a source is made to pass through a narrow slit S as shown in Fig.7.13 and fall on the biprism.

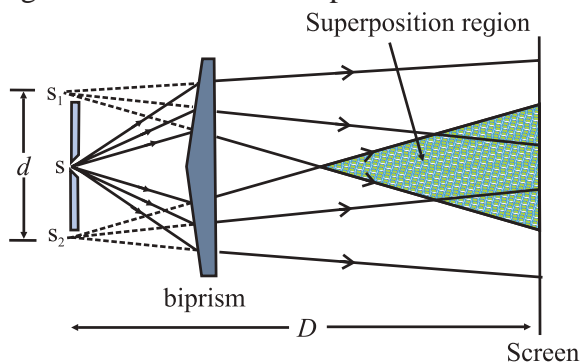

Fig. 7.13: Fresnel Biprism.

The two halves of the biprism form virtual images S₁ and S₂. These are coherent sources

having obtained from a single secondary source S. The two waves coming from S₁ and S₂ interfere and form interference fringes like that in Young's double slit experiment in the shaded region shown in the figure.

Example 7.5: An isosceles prism of refracting angle 179° and refractive index 1.5 is used as a biprism by keeping it 10 cm away from a slit, the edge of the biprism being parallel to the slit. The slit is illuminated by a light of wavelength 500 nm and the screen is 90 cm away from the biprism. Calculate the location of the centre of 20th dark band and the path difference at this location.

Solution: From the figure,

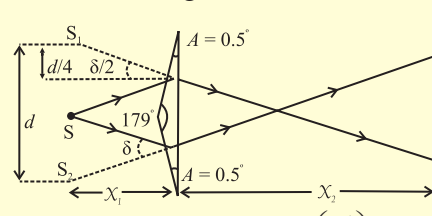

$$\tan\left(\frac{\delta}{2}\right) \cong \left(\frac{\delta}{2}\right)^c = \frac{\left(\frac{d}{4}\right)}{x_1}$$

and for a thin prism, $\delta = A(\mu - 1)$

$$\begin{aligned} \therefore d &= 2\delta x_1 = 2A(\mu - 1)x_1 \\ &= 2\left(0.5 \times \frac{\pi}{180}\right)(1.5 - 1)10 \\ &= \frac{\pi}{36} \text{ cm} \end{aligned}$$

$$\lambda = 500 \text{ nm} = 5 \times 10^{-7} \text{ m,}$$

$$L = 10 \text{ cm} + 90 \text{ cm} = 1 \text{ m}$$

Distance of 20th dark band from the central bright band, $X_{20D} = \left(20 - \frac{1}{2}\right)W$

$$\begin{aligned} \therefore X_{20D} &= (19.5) \frac{\lambda L}{d} \\ &= \frac{19.5 \times (5 \times 10^{-7}) \times 1}{\left(\frac{\pi \times 10^{-2}}{36}\right)} \\ &= \frac{19.5 \times 180 \times 10^{-5}}{\pi} \\ &= 0.1103 \text{ m} \end{aligned}$$

7.8.5 Optical Path:

The phase of a light wave having angular frequency ω and wave vector k , travelling in vacuum along the x direction is given by $(kx - \omega t)$ (Eq. (7.11)). Remember that wave vector k and the angular frequency ω are related as $k = \omega/v$, v being the speed of the wave, which is c in vacuum. If the light wave travels a distance Δx , its phase changes by $\Delta\phi = k\Delta x = \omega\Delta x/v$. If the wave is travelling in vacuum $k = \omega/c$ and $\Delta\phi = \omega\Delta x/c$. In case the wave is travelling in a medium having a refractive index n , then its wave vector k' and angular frequency are related by $k' = \omega/v = \omega/(c/n)$, v being the speed of the wave in this medium. Thus, if the wave travels a distance Δx in this medium, the phase difference generated will be

$$\Delta\phi' = k'\Delta x = \omega n \Delta x / c = \omega \Delta x' / c, \quad \text{--- (7.24)}$$

where, $\Delta x' = n \Delta x$. --- (7.25)

Thus, when a wave travels a distance Δx through a medium having refractive index of n , its phase changes by the same amount as it would if the wave had travelled a distance $n \Delta x$ in vacuum. We can say that a path length of Δx in a medium of refractive index n is equivalent to a path length of $n \Delta x$ in vacuum. $n \Delta x$ is called the *optical path* travelled by a wave. Thus, optical path through a medium is the effective path travelled by light in vacuum to generate the same phase difference. In vacuum, the optical path is equal to the actual path travelled as $n = 1$.

Optical path in a medium can also be defined as the corresponding path in vacuum that the light travels in the same time as it takes in the given medium.

$$\text{Now, time} = \frac{\text{distance}}{\text{speed}} \quad \therefore t = \frac{d_{\text{medium}}}{v_{\text{medium}}} = \frac{d_{\text{vacuum}}}{v_{\text{vacuum}}}$$

$$\therefore \text{Optical path} = d_{\text{vacuum}} = \frac{v_{\text{vacuum}}}{v_{\text{medium}}} \times d_{\text{medium}} \\ = n \times d_{\text{medium}}$$

Thus, a distance d travelled in a medium of

refractive index n introduces a path difference $= nd - d = d(n - 1)$ over a ray travelling equal distance through vacuum.

Two waves interfere constructively when their optical path lengths are equal or differ by integral multiples of the wavelength.

If we introduce a transparent plate of thickness t and refractive index n in front of slit S_1 (Fig. 7.11), then the optical path travelled by the wave along S_1P is higher than that travelled by the wave along S_1P in absence of the plate by $(n-1)t$. Thus, the optical path lengths and therefore, the phases of the rays reaching the midpoint O' from S_1 and S_2 will not be equal. The path lengths will be equal at a point different than O' and so the bright fringe will not occur at O' but at a different point where the two optical path lengths are equal. The dark and bright fringes will be situated symmetrically on both sides of this central fringe. Thus, the whole interference pattern will shift in one direction.

Example 7.6: What must be the thickness of a thin film which, when kept near one of the slits shifts the central fringe by 5 mm for incident light of wavelength 5400 Å in Young's double slit interference experiment? The refractive index of the material of the film is 1.1 and the distance between the slits is 0.5 mm.

Solution: Given $\lambda = 5400 \text{ \AA}$, the refractive index of the material of the film = 1.1 and the shift of the central bright fringe = 5 mm.

Let t be the thickness of the film and P be the point on the screen where the central fringe has shifted. Due to the film kept in front of slit S_1 say, the optical path travelled by the light passing through it increases by $t(1.1-1) = 0.1t$. Thus, the optical paths between the two beams passing through the two slits are not equal at the midpoint of the screen but are equal at the point P , 5 mm away from the centre. At this point the

distance travelled by light from the other slit S_2 to the screen is larger than that from S_1 by $0.1t$.

The difference in distances $S_2P - S_1P = y \lambda/d$, where y is the distance along the screen $= 5 \text{ mm} = 0.005 \text{ m}$ and d is given to be $0.5 \text{ mm} = 0.0005 \text{ m}$.

This has to be equal to the difference in optical paths introduced by the film.

Thus, $0.1t = 0.005 \times 5400 \times 10^{-10}/0.0005$.

$$t = 5.4 \times 10^{-5} \text{ m} = 0.054 \text{ mm}$$

7.9 Diffraction of Light:

We know that shadows are formed when path of light is blocked by an opaque obstacle. Entire geometrical optics is based on the rectilinear propagation of light. However, as discussed earlier, the phenomenon exhibited by light such as interference can only be explained by considering the wave nature of light. Diffraction is another such phenomenon. In certain experiments, light is seen to bend around edges of obstacles in its path and enter into regions where shadows are expected on the basis of geometrical optics. This, so called bending of light around objects, is called the phenomenon of diffraction and is common to all waves. We are very familiar with the fact that sound waves travel around obstacles as we can hear someone talking even though there are obstacles, e.g. a wall, placed between us and the person who is talking. As we will see below, light actually does not bend around edges in diffraction, but is able to reach the shadow region due to the emission by the secondary sources of light on the edge of the obstacle. The phenomenon of diffraction is intimately related to that of interference. Diffraction is essentially the interference of many waves rather than two which we have encountered in interference. Also, diffraction is noticeable only when the size of the obstacle or slits is of the order of the wavelength of

light. As diffraction is a wave phenomenon, it is applicable to sound waves as well. As wavelengths of sound waves are larger, diffraction of sound is easier to observe.

7.9.1 Fresnel and Fraunhofer Diffraction:

Diffraction can be classified into two types depending on the distances involved in the experimental setup.

- 1. Fraunhofer diffraction:** If the distances between the primary source of light, the obstacle/slit causing diffraction and the screen for viewing the diffraction pattern are very large, the diffraction is called Fraunhofer diffraction. In this case, the wavefront incident on the obstacle can be considered to be a plane wavefront. For this, we generally place the source of light at the focus of a convex lens so that a plane wavefront is incident on the obstacle and another convex lens is used on the other side of the obstacle to make the pattern visible on the screen. Figure 7.14 shows this arrangement schematically.
- 2. Fresnel diffraction:** In this case, the distances are much smaller and the incident wavefront is either cylindrical or spherical depending on the source. A lens is not required to observe the diffraction pattern on the screen.

7.9.2 Experimental set up for Fraunhofer diffraction:

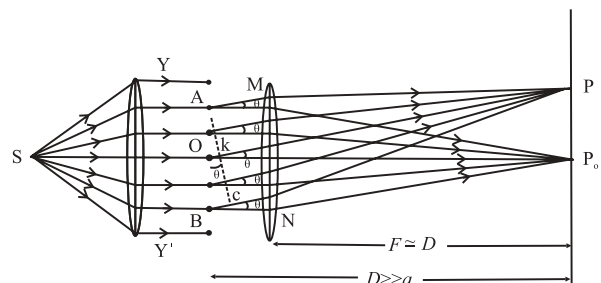

Fig. 7.14: Set up for fraunhofer diffraction .

Figure 7.14 shows a monochromatic source of light S at the focus of a converging lens. Ignoring aberrations, the emerging beam will consist of plane parallel rays resulting in

plane wavefronts. These are incident on the diffracting element such as a slit, a circular aperture, a double slit, a grating, etc. Emerging beam is incident on another converging lens that focuses the beam on a screen.

In the case of a circular aperture, S is a point source and the lenses are bi-convex. For linear elements like slits, grating, etc., the source is linear and the lenses are cylindrical in shape so that the focussed image is also linear. In either case, a plane wavefront (as if the source is at infinity) approaches and leaves the diffracting element. This is as per the requirements of Fraunhofer diffraction.

7.9.3 Fraunhofer Diffraction at a Single Slit:

Figure 7.14 shows the cross section of a plane wavefront YY' incident on a single slit of width AB . The centre of the slit is at point O . As the width of the slit is in the plane of the paper, its length is perpendicular to the paper. The slit can be imagined to be divided into a number of extremely thin slits (or slit elements). The moment the plane wavefront reaches the slit, each slit element becomes the secondary source of cylindrical wavefronts responsible for diffraction in all possible directions. A cylindrical lens (with its axis parallel to the slit) kept next to the slit converges the emergent beams on to the screen kept at the focus. The distance D between the slit and the screen is practically the focal length F of the lens. For all practical set ups, the width a of the slit is of the order of 10^{-4} to 10^{-3} m and distance D is of the order of 10 m, i.e., $D \gg a$.

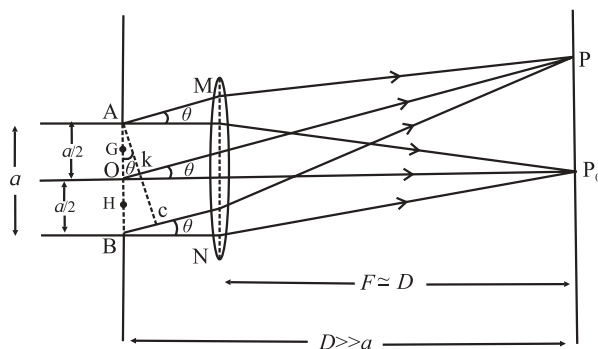

Fig. 7.15: Fraunhofer diffraction .

Location of minima and maxima: Figure 7.15 is a part of figure 7.14. It shows two sets of parallel rays originating at the slit elements. The central and symmetric beam focuses at the central point (line) P_0 , directly in front of O , the center of the slit.

Rays parallel to the axis from all points from A to B are focused at the central point P_0 . Thus, all these rays must be having equal optical paths. Hence all these arrive at P_0 with the same phase, and thereby produced constructive interference at P_0 .

In the case of point P at angular position θ the optical paths of the rays from A to C till point P are equal as AC is normal to AM . From this points onwards, there is no path difference or phase difference between these rays. Hence, the paths of rays between AB and AC are responsible for the net path difference or phase difference at point P . The path difference between extreme rays is $BC = a \sin \theta$. Let this be equal to λ .

Let K be the midpoint of AC . $\therefore OK = \frac{1}{2} BC = \frac{\lambda}{2}$

Thus, the path difference between AP and OP is $\lambda/2$. As a result, these two rays (waves) produce destructive interference at P . Now consider any pair of points equidistant respectively from A and O , such as G and H , separated by distance $a/2$ along the slit. Rays (waves) from any such pair will have a path difference of $\lambda/2$ at P . Thus, all such pairs of points between AO and OB will produce destructive interference at P . This makes point P to be the first minimum.

This discussion can be extended to points on the screen having path differences $2\lambda, 3\lambda, \dots, n\lambda$ between the extreme rays reaching them and it can be seen that these points will be dark and hence will be positions of dark fringes.

Again, the same logic is applicable for points on the other side of P_0 .

Hence, at the location of n^{th} minima, the path difference between the extreme rays

$$a \sin \theta = \pm n \lambda \quad \text{--- (7.26)}$$

If we assume the maxima to be in between the respective minima, we can write the path difference between the extreme rays at the n^{th} maxima as

$$a \sin \theta = \pm \left(n + \frac{1}{2} \right) \lambda \quad \text{--- (7.27)}$$



Do you know?

- Why did we use λ as the path difference between the waves originating from extreme points for the first minima?
- On receiving energy from two waves, at the position of the first dark fringe, the path difference between the two waves must be $\lambda/2$. In the case of a single slit, a point on the screen receives waves from all the points on the slit. For the point on the screen to be dark, there must be a path difference of $\lambda/2$ for all pairs of waves. One wave from this pair is from upper half part of the slit and the other is from the lower half e.g., points A and O, G and H, O and B, etc. Thus, the minimum path difference between the waves originating from the extreme points A and B must be $\frac{\lambda}{2} + \frac{\lambda}{2} = \lambda$.

In reality, these are nearly midway and not exactly midway between the dark fringes.

Distances of minima and maxima from the central bright point, (i.e., the distances on the screen):

Equations (7.26) and (7.27) relate the path difference at the locations of n^{th} dark and n^{th} bright point respectively. As described earlier, the distance $D \gg a$. Hence the angle θ is very small. Thus, if it is expressed in radian, we can write, $\sin \theta \cong \tan \theta \cong \theta = \frac{y}{D}$ where y is the distance of point P, on the screen from the central bright point, the screen being at a distance D from the diffracting element (single slit).

Let y_{nd} and y_{nb} be the distances of n^{th} dark point and n^{th} bright point from the central bright point.

Thus, at the n^{th} dark point on either side of the central bright point, using Eq. (7.26)

$$\theta_{nd} = \frac{y_{nd}}{D} = n \frac{\lambda}{a}, \quad y_{nd} = n \frac{\lambda D}{a} = nW \quad \text{--- (7.28)}$$

Also, at the n^{th} bright point on either side of the central bright point, using Eq. (7.27)

$$\theta_{nb} \cong \frac{y_{nb}}{D} \cong \left(n + \frac{1}{2} \right) \frac{\lambda}{a} \quad \text{--- (7.29)}$$

$$y_{nb} \cong \left(n + \frac{1}{2} \right) \frac{\lambda D}{a} \cong \left(n + \frac{1}{2} \right) W,$$

where, $W = \frac{\lambda D}{a}$ is similar to the fringe width in the interference pattern. In this case also it is the distance between consecutive bright fringes or consecutive dark fringes, except the central (zeroth) bright fringe.

Width of the central bright fringe:

The central bright fringe is spread between the first dark fringes on either side. Thus, width of the central bright fringe is the distance between the centres of first dark fringe on either side.

\therefore Width of the central bright fringe,

$$W_c = 2y_{1d} = 2W = 2 \left(\frac{\lambda D}{a} \right)$$

7.9.4 Comparison of Young's Double Slit Interference Pattern and Single Slit Diffraction Pattern:

For a common laboratory set up, the slits in the Young's double slit experiment are much thinner than their separation. They are usually obtained by using a biprism or a Lloyd's mirror. The separation between the slits is a few mm only. With best possible set up, we can usually see about 30 to 40 equally spaced bright and dark fringes of nearly same brightness.

The single slit used to obtain the diffraction pattern is usually of width less than 1 mm. Taken on either side, we can see around 20 to 30 fringes with central fringe being the brightest. Also, width of the central

bright fringe is twice that of all the other bright fringes (in the single slit diffraction pattern). Table 7.1 gives mathematical comparison

between interference and diffraction patterns and Fig. (7.16) shows corresponding $(I - \theta)$ graphs.

Remember the following while using the table:

Central bright fringe is the ZEROth bright fringe ($n = 0$), and not the first.

d : slit separation, a : slit width, D : Slit/s to screen separation

W : Separation between consecutive bright or dark fringes.

Table 7.1: Comparison between interference and diffraction patterns

Physical quantity		Young's double slit interference Pattern	Single slit diffraction pattern
Fringe width W		$W = \frac{\lambda D}{d}$	$W = \frac{\lambda D}{a}$ Except for the central bright fringe
For n^{th} bright fringe	Phase difference, δ between extreme rays	$n(2\pi)$	$\left(n + \frac{1}{2}\right)(2\pi)$
	Angular position, θ	$n\left(\frac{\lambda}{d}\right)$	$\left(n + \frac{1}{2}\right)\left(\frac{\lambda}{d}\right)$
	Path difference, Δx between extreme rays	$n\lambda$	$\left(n + \frac{1}{2}\right)\lambda$
	Distance from the central bright spot, y	$n\left(\frac{\lambda D}{d}\right) = nW$	$\left(n + \frac{1}{2}\right)\left(\frac{\lambda D}{a}\right) = nW$
For n^{th} dark fringe	Phase difference, δ between extreme rays	$\left(n - \frac{1}{2}\right)(2\pi)$	$n(2\pi)$
	Angular position, θ	$\left(n - \frac{1}{2}\right)\left(\frac{\lambda}{d}\right)$	$n\left(\frac{\lambda}{d}\right)$
	Path difference, Δx between extreme rays	$\left(n - \frac{1}{2}\right)\lambda$	$n\lambda$
	Distance from the central bright spot, y	$\left(n - \frac{1}{2}\right)\left(\frac{\lambda D}{d}\right) = nW$	$n\left(\frac{\lambda D}{a}\right) = nW$

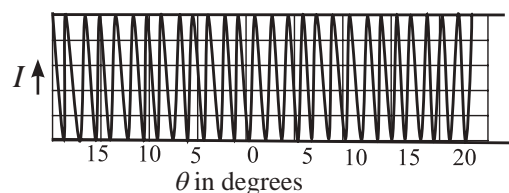

(a)

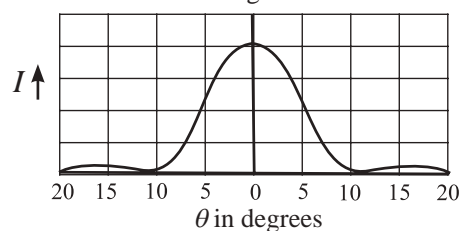

(b)

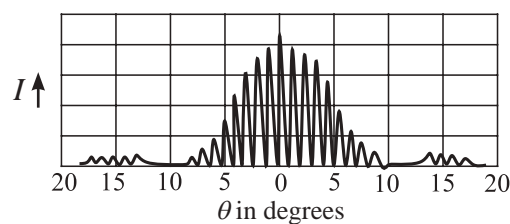

(c)

Fig.7.16: Intensity I distribution in (a) Young's double slit interference (b) single slit diffraction and (c) double slit diffraction.

Double slit diffraction pattern:

What pattern will be observed due to diffraction from two slits rather than one? In this case the pattern will be decided by the diffraction pattern of the individual slits, as well as by the interference between them. The pattern is shown in Fig.7.16 (c). There are narrow interference fringes similar to those in Young's double slit experiment, but of varying brightness and the shape of their envelope is that of the single slit diffraction pattern.

7.10 Resolving Power:

Diffraction effect is most significant while discussing the resolving power of an optical instrument. We use an optical instrument to see minor details of all the parts of an object or to see distinct images of different nearby objects and not only for magnification.

Consider your friend showing two of her fingers (as we do while showing a victory sign) from a distance less than 10 m. You can easily point out that she is showing two fingers, i.e., you can easily distinguish the two fingers. However, if she shows the same two fingers from a distance over 50 m, most of you will NOT be able to distinguish the two fingers, i.e., you can't definitely say whether those are two fingers or it is a single finger.

This ability to distinguish two physically separated objects as two distinct objects is known as the resolving power of an optical instrument. In the example given, it was your eye. In other words, from a distance less than 10 m, your eye is able to *resolve* the two fingers. From beyond 50 m, it may not possible for you to resolve the two fingers.

Resolving power of an optical instrument (an eye, a microscope, a telescope, etc.) generally depends upon the aperture (usually the diameter of the lens or mirror) and the wavelength of the light used. In general, the resolving ability of an instrument is stated in terms of the visual angle, which is the angle subtended at the eye by the two objects to

be resolved (which are assumed to be point objects). It is the minimum visual angle between two objects that can be resolved by that instrument. This minimum angle is called limit of resolution. Reciprocal of the limit of resolution is called the resolving power.

7.10.1 Rayleigh's Criterion for Limit of Resolution (or for Resolving Power):

According to Lord Rayleigh, the ability of an optical instrument to distinguish between two closely spaced objects depends upon the diffraction patterns of the two objects (slits, point objects, stars, etc.), produced at the screen (retina, eyepiece, etc.). According to this criterion, two objects are *just resolved* when the first minimum of the diffraction pattern of one source coincides with the central maximum of the other source, and vice versa.

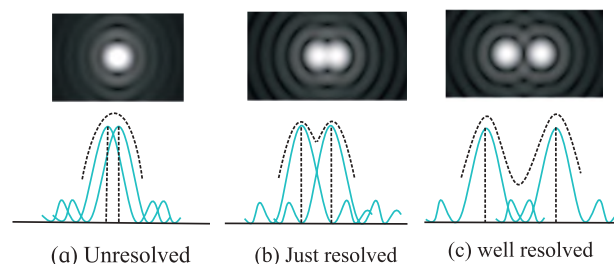

Fig. 7.17 Rayleigh's criterion for resolution of objects.

In Fig. 7.17(b), first minimum of the diffraction pattern of second object is coinciding with the central maximum of the first and vice versa. In such case we find the objects to be just resolved as the depression in the resultant envelope is noticeable. For Fig 7.17(a), the depression is not noticeable and in Fig 7.17(c), it can be clearly noticed.

(i) Two linear objects: Consider two self luminous objects (slits) separated by some distance. As per Rayleigh's criterion, the first minimum of the diffraction pattern of one of the sources should coincide with the central maximum of the other. Graphical pattern of the diffraction by two slits at the *just resolved* condition is as shown in the lower half of the

Fig 7.17(b). Angular separation (position) of the first principal minimum is

$$d\theta = \frac{\lambda}{a} \quad \text{--- (7.28)}$$

As this minimum coincides with the central maximum of the other, this must be the minimum angular separation between the two objects, and hence the limit of resolution of that instrument.

$$\therefore \text{Limit of resolution, } d\theta = \frac{\lambda}{a}$$

Minimum separation between the two linear objects that are just resolved, at distance D from the instrument, is

$$y = D(d\theta) = \frac{D\lambda}{a} \quad \text{--- (7.29)}$$

It is obviously the distance of the first minimum from the centre.

(ii) Pair of Point objects: In the case of a microscope, quite often, the objects to be viewed are similar to point objects. The diffraction pattern of such objects consists of a central bright disc surrounded by concentric rings, called Airy disc and rings as shown in Fig. 7.18 (a). Abbe was the first to study this thoroughly, and apply it to Fraunhofer diffraction.

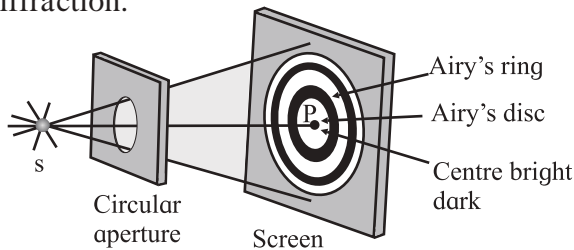

Fig 7.18 (a): A schematic diagram showing formation of Airy disc and rings.

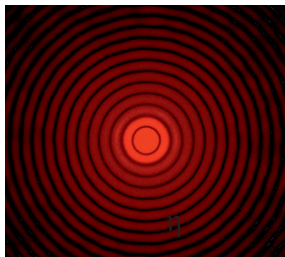

Fig 7.18 (b): A real Airy disc obtained by using a laser.

Figure (7.18 (b)) shows a real Airy disk formed by passing a red laser beam through a $90 \mu\text{m}$ pinhole aperture that shows several orders (rings) of diffraction.

According to Lord Rayleigh, for such objects to be just resolved, the first dark ring of the diffraction pattern of the first object should be formed at the centre of the diffraction pattern of the second, and vice versa. In other words, the minimum separation between the images on the screen is radius of the first dark ring (Fig. 7.17 (b) and Fig. 7.19 (a))

The discussion till here is applicable to any instrument such as an eye, a microscope, a telescope, etc.

7.10.2 Resolving Power of a Microscope:

Fig 7.19 shows two point objects O and O' separated by a distance a in front of an objective AB of a microscope. Medium between the objects and the objective is of refractive index n . Wavelength of the light emitted by the sources in the medium is λ_n . Angular separation between the objects, at the objective is 2α .

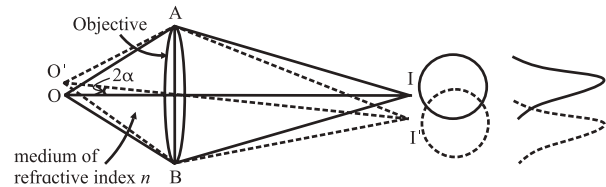

Fig 7.19 (a) : Resolution of objects by a microscope.

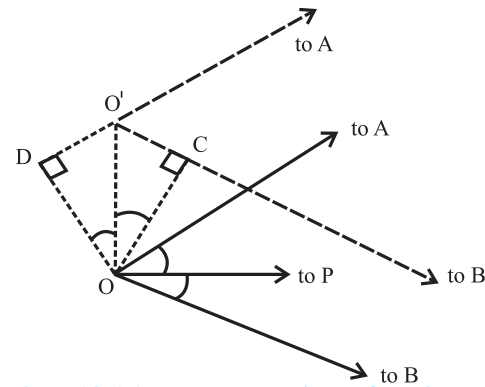

Fig 7.19 (b): Enlarged view of region around O and O' in Fig. 7.19 (a).

I and I' are centers of diffraction patterns (Airy discs and rings) due to O and O' on the screen (effectively at infinity). According to Rayleigh's criterion the first dark ring due to O' should coincide with I and that of O should coincide with I' . The nature of illumination at a point on the screen is decided by the

effective path difference at that point. Let us consider point I where first dark ring due to O' is located. Paths of the extreme rays reaching I from O' are O'AI and O'BI. As point I is symmetric with respect to O, the paths AI and BI are equal. Thus, the actual path difference is O'B - O'A.

The region around O' and O is highly enlarged in Fig. 17.19 (b). From this figure it can be proved that

$$\begin{aligned} \text{path difference} &= DO' + O'C \\ &= 2a \sin \alpha \quad \text{--- (7.30)} \end{aligned}$$

(i) Microscope with a pair of non-luminous objects (dark objects): In common microscopy, usually self-luminous objects are not observed. Non-luminous objects are illuminated by some external source. In general, this illumination is not normal, but it is oblique. Also majority of the objects viewed through a microscope can be considered to be point objects producing Airy rings in their diffraction patterns. Often the eye piece is filled with some transparent material. Let the wavelength of light in this material be $\lambda_n = \lambda/n$, λ being the wavelength of light in air and n is the refractive index of the medium. In such a set-up the path difference at the first dark ring is λ_n . Thus, from Eq. (7.30) $2a \sin \alpha = \lambda_n = \lambda/n$

$$a = \frac{\lambda}{2n \sin \alpha} = \frac{\lambda}{2(N.A.)} \quad \text{--- (7.31)}$$

The factor $n \sin \alpha$ is called numerical aperture (N. A.).

$$\text{The resolving power, } R = \frac{1}{a} = \frac{2(N.A.)}{\lambda} \quad \text{--- (7.32)}$$

(ii) Microscope with self luminous point objects: Applying Abbe's theory of Airy discs and rings to Fraunhofer diffraction due to a pair of self luminous point objects, the path difference between the extreme rays, at the first dark ring is given by 1.22λ ,

Thus, for the requirement of just resolution,

$$2a \sin \alpha = 1.22 \lambda_n$$

$$\therefore a = \frac{1.22 \lambda_n}{2 \sin \alpha}$$

$$\therefore a = \frac{1.22 \lambda}{2n \sin \alpha} = \frac{0.61 \lambda}{n \sin \alpha} = \frac{0.61 \lambda}{(N.A.)} \quad \text{--- (7.33)}$$

$$\text{The resolving power } R = \frac{1}{a} = \frac{(N.A.)}{0.61 \lambda} \quad \text{--- (7.34)}$$

For better resolution, a should be minimum. This can be achieved by using an oil filled objective which provides higher value of n .



Do you know?

- The expression of resolving power of a microscope is inversely proportional to the wavelength λ used to illuminate the object. Can we have a source with a very small wavelength compared to that of the visible light?
- You will study later in Chapter 14 that electrons exhibit wave like behaviour. By controlling the speed of the electrons, we can control their wavelength. This principle is used in Electron Microscopes. Modern electron microscopes can have a magnification $\sim 10^6$ and can resolve objects with separation < 10 nm. For ordinary optical microscopes the minimum separation is generally around 10^{-3} mm.

7.10.3 Resolving Power of a Telescope:

Telescopes are normally used to see distant stars. For us, these stars are like luminous point objects, and are far off. Thus, their diffraction patterns are Airy discs. Also, as the objects to be seen are far off, only the angular separation between the two is of importance and not the linear separation between them. Fig. 7.20 shows objective AB of a telescope receiving two sets of parallel beams from two distant objects with an angular separation θ . *Resolving power of a telescope is then defined as the reciprocal of the least angular separation between the objects that are just resolved.*

According to Rayleigh's criterion, the minimum separation between the images I and I' must be equal to the radius of the first dark Airy ring.

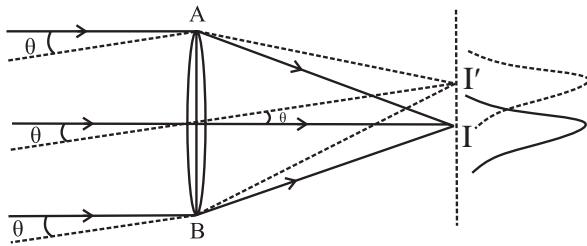

Fig. 7.20: Resolution by a telescope.

If Airy's theory is applied to Fraunhofer diffraction of a pair of point objects, the path difference between the extreme rays, at the first dark ring is given by 1.22λ .

$$\therefore BI' - AI' = 1.22\lambda$$

If D is the aperture of the telescope (diameter AB of its objective),

$$BI' - AI' \cong D \times \theta = 1.22\lambda$$

$$\therefore \theta = \frac{1.22\lambda}{D} \quad \text{and} \quad R = \frac{1}{\theta} = \frac{D}{1.22\lambda} \quad \text{--- (7.35)}$$

Thus, to increase the resolving power of a telescope (for a given wavelength), its objective (aperture) should be as large as possible. Using a large lens invites a lot of difficulties such as aberrations, initial moulding of the lens, post launch issues such as heavy mass for changing the settings, etc. The preferred alternative is to use a front coated curved mirror as the objective. As discussed in XIth Std. a parabolic mirror is used in order to eliminate the spherical aberration. Again, constructing a single large mirror invites other difficulties. Recent telescopes use segmented mirrors that have a number of hexagonal segments to form a large parabolic mirror. Two largest optical telescopes under construction have 30 m and 40 m for the diameters of their mirrors.

Radio Telescope: Wavelengths of radio waves are in metres. According to Eq. (7.35), if we want to have same limit of resolution as that of an optical telescope, the diameter (aperture) of the radio telescopes should be very large (at least some kilometres). Obviously a single disc of such large diameters is impracticable. In such cases arrays of antennae spread over several kilometres are used. Giant Metre-wave Radio Telescope (GMRT) located at Narayangaon, near Pune, Maharashtra uses

such an array consisting of 30 dishes of 45 m diameter each, spread over 25 km. It is the largest distance between two of its antennae. A photograph of 5 GMRT dishes is shown in Fig. 7.21.



Fig. 7.21 : GMRT Radio Telescope.

The highest angular resolution achievable ranges from about 60 arcsec (arcsec is 3600th part of a degree) at the lowest frequency of 50 MHz to about 2 arcsec at 1.4 GHz.

Example 7.7: A telescope has an objective of diameter 2.5 m. What is its angular resolution when it observes at 5500 Å?

Solution: Angular resolution, $\Delta\theta = 1.22 \lambda / a$,
 a being the diameter of the aperture
 $= 1.22 \times 5.5 \times 10^{-7} / 2.5 = 2.684 \times 10^{-7} \text{ rad}$
 $= 0.06 \text{ arcsec}$

Example 7.8: What is the minimum distance between two objects which can be resolved by a microscope having the visual angle of 30° when light of wavelength 500 nm is used?

Solution: According to Eq. (7.33) the minimum distance is given by

$$d_{\min} = 0.61 \lambda / \tan \beta$$

$$d_{\min} = 0.61 \times 5.0 \times 10^{-7} / \tan 30^\circ = 5.28 \times 10^{-7} \text{ m.}$$



Internet my friend

1. https://en.wikipedia.org/wiki/Wave_interference
2. <http://hyperphysics.phy-astr.gsu.edu/hbase/phyopt/interfcon.html>
3. <http://hyperphysics.phy-astr.gsu.edu/hbase/phyopt/diffraccon.html>
4. <https://opentextbc.ca/physicstestbook2/chapter/limits-of-resolution-the-rayleigh-criterion/>



Exercises

1. Choose the correct option.

- i) Which of the following phenomenon proves that light is a transverse wave?
 - (A) reflection
 - (B) interference
 - (C) diffraction
 - (D) polarization
- ii) Which property of light does not change when it travels from one medium to another?
 - (A) velocity
 - (B) wavelength
 - (C) amplitude
 - (D) frequency
- iii) When unpolarized light is passed through a polarizer, its intensity
 - (A) increases
 - (B) decreases
 - (C) remains unchanged
 - (D) depends on the orientation of the polarizer
- iv) In Young's double slit experiment, the two coherent sources have different intensities. If the ratio of maximum intensity to the minimum intensity in the interference pattern produced is 25:1. What was the ratio of intensities of the two sources?
 - (A) 5:1
 - (B) 25:1
 - (C) 3:2
 - (D) 9:4
- v) In Young's double slit experiment, a thin uniform sheet of glass is kept in front of the two slits, parallel to the screen having the slits. The resulting interference pattern will satisfy
 - (A) The interference pattern will remain unchanged
 - (B) The fringe width will decrease
 - (C) The fringe width will increase
 - (D) The fringes will shift.

2. Answer in brief.

- i) What are primary and secondary sources of light?
 - ii) What is a wavefront? How is it related to rays of light? What is the shape of the wavefront at a point far away from the source of light?
 - iii) Why are multiple colours observed over a thin film of oil floating on water? Explain with the help of a diagram.
- iv) In Young's double slit experiment what will we observe on the screen when white light is incident on the slits but one slit is covered with a red filter and the other with a violet filter? Give reasons for your answer.
 - v) Explain what is optical path length. How is it different from actual path length?
3. Derive the laws of reflection of light using Huygens' principle.
 4. Derive the laws of refraction of light using Huygens' principle.
 5. Explain what is meant by polarization and derive Malus' law.
 6. What is Brewster's law? Derive the formula for Brewster angle.
 7. Describe Young's double slit interference experiment and derive conditions for occurrence of dark and bright fringes on the screen. Define fringe width and derive a formula for it.
 8. What are the conditions for obtaining good interference pattern? Give reasons.
 9. What is meant by coherent sources? What are the two methods for obtaining coherent sources in the laboratory?
 10. What is diffraction of light? How does it differ from interference? What are Fraunhofer and Fresnel diffractions?
 11. Derive the conditions for bright and dark fringes produced due to diffraction by a single slit.
 12. Describe what is Rayleigh's criterion for resolution. Explain it for a telescope and a microscope.
 13. White light consists of wavelengths from 400 nm to 700 nm. What will be the wavelength range seen when white light is passed through glass of refractive index 1.55?
[Ans: 258.06 - 451.61 nm]
 14. The optical path of a ray of light of a given wavelength travelling a distance of 3 cm in flint glass having refractive

- index 1.6 is same as that on travelling a distance x cm through a medium having refractive index 1.25. Determine the value of x .
[Ans: 3.84 cm]
15. A double-slit arrangement produces interference fringes for sodium light ($\lambda = 589$ nm) that are 0.20° apart. What is the angular fringe separation if the entire arrangement is immersed in water ($n = 1.33$)?
[Ans: 0.15°]
16. In a double-slit arrangement the slits are separated by a distance equal to 100 times the wavelength of the light passing through the slits. (a) What is the angular separation in radians between the central maximum and an adjacent maximum? (b) What is the distance between these maxima on a screen 50.0 cm from the slits?
[Ans: 0.01 rad, 0.5 cm]
17. Unpolarized light with intensity I_0 is incident on two polaroids. The axis of the first polaroid makes an angle of 50° with the vertical, and the axis of the second polaroid is horizontal. What is the intensity of the light after it has passed through the second polaroid?
[Ans: $I_0/2 \times (\cos 40^\circ)^2$]
18. In a biprism experiment, the fringes are observed in the focal plane of the eyepiece at a distance of 1.2 m from the slits. The distance between the central bright band and the 20th bright band is 0.4 cm. When a convex lens is placed between the biprism and the eyepiece, 90 cm from the eyepiece, the distance between the two virtual magnified images is found to be 0.9 cm. Determine the wavelength of light used.
[Ans: 5000 Å]
19. In Fraunhofer diffraction by a narrow slit, a screen is placed at a distance of 2 m from the lens to obtain the diffraction pattern. If the slit width is 0.2 mm and the first minimum is 5 mm on either side of the central maximum, find the wavelength of light.
[Ans: 5000 Å]
20. The intensity of the light coming from one of the slits in Young's experiment is twice the intensity of the light coming from the other slit. What will be the approximate ratio of the intensities of the bright and dark fringes in the resulting interference pattern?
[Ans: 34]
21. A parallel beam of green light of wavelength 546 nm passes through a slit of width 0.4 mm. The intensity pattern of the transmitted light is seen on a screen which is 40 cm away. What is the distance between the two first order minima?
[Ans: 1.1 mm]
22. What must be the ratio of the slit width to the wavelength for a single slit to have the first diffraction minimum at 45.0° ?
[Ans: 1.27]
23. Monochromatic electromagnetic radiation from a distant source passes through a slit. The diffraction pattern is observed on a screen 2.50 m from the slit. If the width of the central maximum is 6.00 mm, what is the slit width if the wavelength is (a) 500 nm (visible light); (b) 50 μm (infrared radiation); (c) 0.500 nm (X-rays)?
[Ans: 0.416 mm, 41.6 mm, 4.16×10^{-4} mm]
24. A star is emitting light at the wavelength of 5000 Å. Determine the limit of resolution of a telescope having an objective of diameter of 200 inch.
[Ans: 1.2×10^{-7} rad]
25. The distance between two consecutive bright fringes in a biprism experiment using light of wavelength 6000 Å is 0.32 mm by how much will the distance change if light of wavelength 4800 Å is used?
[Ans: 0.064 mm]

8. Electrostatics



Can you recall?

1. What are conservative forces?
2. What is potential energy ?
3. What is Gauss' law and what is a Gaussian surface?

8.1 Introduction:

In XIth Std we have studied the Gauss' Law which gives the relationship between the electric charge and its electric field. It also provides equivalent methods for finding electric field intensity by relating values of the field at a closed surface and the total charges enclosed by that surface. It is a powerful tool which can be applied for the calculation of the electric field when it originates from charge distribution of sufficient symmetry. The law can be written as

$$\phi = \frac{q}{\epsilon_0} = \oint \vec{E} \cdot \vec{ds} \quad \text{--- (8.1)}$$

where ϕ is the total flux coming out of a closed surface and q is the total charge inside the closed surface.

Common steps involved in calculating electric field intensity by using Gauss' theorem:

1. Describe the charge distribution (linear/surface/volume)
2. Obtain the flux by Gauss' theorem (Let this be Eq. (A))
3. Visualize a Gaussian surface and justify it.
4. With the electric field intensity E as unknown, obtain electric flux by calculation, using geometry of the structure and symmetry of the Gaussian surface (Let this be Eq. (B))
5. Equate RHS of Eq. (A) and Eq. (B) and calculate E .

8.2 Application of Gauss' Law:

In this section we shall see how to obtain the electric field intensity for some symmetric

charge configurations with the help of some examples.

8.2.1 Electric Field Intensity due to Uniformly Charged Spherical Shell or Hollow Sphere:

Consider a sphere of radius R with its centre at O , charged to a uniform charge density σ (C/m^2) placed in a dielectric medium of permittivity ϵ ($\epsilon = \epsilon_0 k$). The total charge on the sphere, $q = \sigma \times 4\pi R^2$

By Gauss' theorem, the net flux through a closed surface

$$\phi = q/\epsilon_0 \quad (\text{for air/vacuum } k=1)$$

where q is the total charge inside the closed surface.

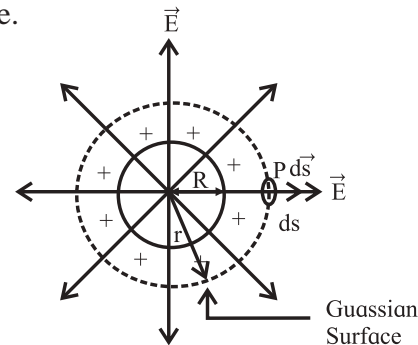

Fig. 8.1: Uniformly charged spherical shell or hollow sphere.

To find the electric field intensity at a point P , at a distance r from the centre of the charged sphere, imagine a concentric Gaussian sphere of radius r passing through P . Let ds be a small area around the point P on the Gaussian surface. Due to symmetry and spheres being concentric, the electric field at each point on the Gaussian surface has the same magnitude E and it is directed radially outward. Also, the angle between the direction of E and the normal to the surface of the sphere (ds) is zero i.e., $\cos \theta = 1$

$$\therefore \vec{E} \cdot \vec{ds} = E ds \cos \theta = E ds$$

$$\therefore \text{flux } d\phi \text{ through the area } ds = E ds$$

Total electric flux through the Gaussian surface $\phi = \oint \vec{E} \cdot \vec{ds} = \oint E ds = E \oint ds$

$$\therefore \phi = E 4\pi r^2 \quad \text{--- (8.2)}$$

From equations (8.1) and (8.2),

$$q/\epsilon_0 = E 4\pi r^2$$

$$\therefore E = q/4\pi\epsilon_0 r^2 \quad \text{--- (8.3)}$$

Since $q = \sigma \times 4\pi R^2$

We have $E = \sigma \times 4\pi R^2 / 4\pi\epsilon_0 r^2$

$$\therefore E = \sigma R^2 / \epsilon_0 r^2 \quad \text{--- (8.4)}$$

From Eqn. (8.3) it can be seen that, the electric field at a point outside the shell is the same as that due to a point charge. Thus it can be concluded that a uniformly charged sphere is equivalent to a point charge at its center.

Case (i) If point P lies on the surface of the charged sphere: $r = R$

$$\therefore E = q/4\pi\epsilon_0 R^2 = \sigma/\epsilon_0$$

Case (ii) If point P lies inside the sphere: Since there are no charges inside $\sigma = 0$,

$$\therefore E = 0.$$

Example : 8.1

A sphere of radius 10 cm carries a charge of $1\mu\text{C}$. Calculate the electric field

- (i) at a distance of 30 cm from the center of the sphere
- (ii) at the surface of the sphere and
- (iii) at a distance of 5 cm from the center of the sphere.

Solution: Given: $q = 1\mu\text{C} = 1 \times 10^{-6} \text{C}$

(i) Electric intensity at a distance r is

$$E = q/4\pi\epsilon_0 r^2$$

For $r = 30 \text{ cm} = 0.3 \text{ m}$

$$E = \frac{9 \times 10^9 \times 1 \times 10^{-6}}{(0.3)^2} = 10^5 \text{ N/C}$$

(ii) E on the surface of the sphere, $R = 10 \text{ cm} = 0.10 \text{ m}$

$$E = q/4\pi\epsilon_0 R^2$$

$$= \frac{9 \times 10^9 \times 1 \times 10^{-6}}{(0.10)^2} = 9 \times 10^5 \text{ N/C}$$

(iii) E at a point 5 cm away from the centre i.e. inside the sphere $E = 0$.

8.2.2 Electric Field Intensity due to an Infinitely Long Straight Charged Wire:

Consider a uniformly charged wire of infinite length having a constant linear charge density λ (charge per unit length), kept in a medium of permittivity ϵ ($\epsilon = \epsilon_0 k$).

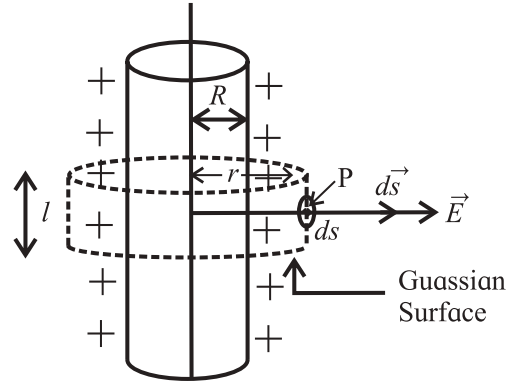

Fig. 8.2: Infinitely long straight charged wire (cylinder).

To find the electric field intensity at P, at a distance r from the charged wire, imagine a coaxial Gaussian cylinder of length l and radius r (closed at each end by plane caps normal to the axis) passing through the point P. Consider a very small area ds at the point P on the Gaussian surface.

By symmetry, the magnitude of the electric field will be the same at all the points on the curved surface of the cylinder and will be directed radially outward. The angle between the direction of \vec{E} and the normal to the surface of the cylinder (\vec{ds}) is zero i.e., $\cos \theta = 1$

$$\therefore \vec{E} \cdot \vec{ds} = E ds \cos \theta = E ds$$

Flux $d\phi$ through the area $ds = E ds$.

Total electric flux through the Gaussian surface $\phi = \oint \vec{E} \cdot \vec{ds} = \oint E ds = E \oint ds$

$$\therefore \phi = E \cdot 2\pi r l \quad \text{--- (8.5)}$$

From equations (8.1) and (8.5)

$$q/\epsilon_0 = E 2\pi r l$$

Since $\lambda = q/l$, $q = \lambda l$

$$\therefore \lambda l / \epsilon_0 = E 2\pi r l$$

$$E = \lambda / 2\pi\epsilon_0 r \quad \text{--- (8.6)}$$

The direction of the electric field E is directed outward if λ is positive and inward if λ is negative (Fig 8.3).

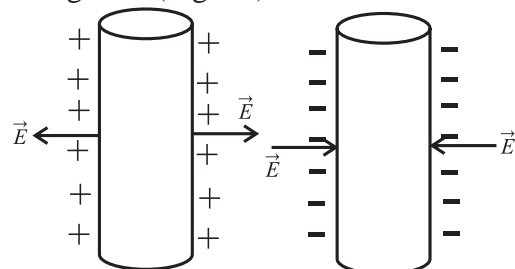

Fig. 8.3: Direction of the field for two types of charges.

Example 8.2: The length of a straight thin wire is 2 m. It is uniformly charged with a positive charge of $3\mu\text{C}$. Calculate
 (i) the charge density of the wire
 (ii) the electric intensity due to the wire at a point 1.5 m away from the center of the wire

Solution: Given

charge $q = 3\mu\text{C} = 3 \times 10^{-6}\text{ C}$

Length $l = 2\text{ m}$, $r = 1.5\text{ m}$

(i) Charge Density $\lambda = \text{Charge}/\text{length}$

$$= \frac{3 \times 10^{-6}}{2} = 1.5 \times 10^{-6}\text{ C m}^{-1}$$

(ii) Electric Intensity $E = \lambda / 2\pi\epsilon_0 r$

$$= \frac{1.5 \times 10^{-6}}{2 \times 3.142 \times 8.85 \times 10^{-12} \times 1.5}$$

$$= 1.798 \times 10^4\text{ N C}^{-1}$$

8.2.3 Electric Field due to a Charged Infinite Plane Sheet:

Consider a uniformly charged infinite plane sheet with surface charge density σ . By symmetry electric field is perpendicular to plane sheet and directed outwards, having same magnitude at a given distance on either sides of the sheet. Let P be a point at a distance r from the sheet and E be the electric field at P.

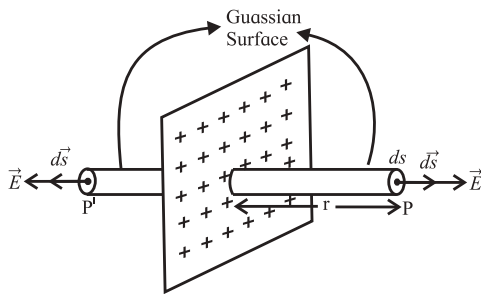

Fig. 8.4: Charged infinite plane sheet.

To find the electric field due to a charged infinite plane sheet at P, we consider a Gaussian surface around P in the form of a cylinder having cross sectional area A and length 2r with its axis perpendicular to the plane sheet. The plane sheet passes through the middle of the length of the cylinder such that the ends of the cylinder (called end caps P and P') are equidistant (at a distance r) from the plane sheet.

By symmetry the electric field is at right angles to the end caps and away from the plane. Its magnitude is the same at P and P'. The flux passing through the curved surface is zero as the electric field is tangential to this surface.

\therefore the total flux through the closed surface is given by

$$\phi = \left[\oint E ds \right]_p + \left[\oint E ds \right]_{p'}$$

(since $\theta = 0$, $\cos \theta = 1$)

$$= EA + EA$$

$$\therefore \phi = 2EA \quad \text{--- (8.7)}$$

If σ is the surface charge density then

$$\sigma = q/A, q = \sigma A$$

\therefore Eq. (8.1) can be written as

$$\phi = \sigma A / \epsilon_0 \quad \text{--- (8.8)}$$

From Eq. (8.7) and Eq. (8.8)

$$2EA = \sigma A / \epsilon_0 \therefore E = \sigma / 2\epsilon_0$$

Example: 8.3 The charge per unit area of a large flat sheet of charge is $3\mu\text{C}/\text{m}^2$. Calculate the electric field intensity at a point just near the surface of the sheet, measured from its midpoint.

Solution: Given

Surface Charge Density $= \sigma = 3 \times 10^{-6}\text{ Cm}^{-2}$

Electric Intensity $E = \sigma / 2\epsilon_0$

$$= \frac{3 \times 10^{-6}}{2 \times 8.85 \times 10^{-12}} = 1.7 \times 10^5\text{ N C}^{-1}$$



Can you recall?

What is gravitational Potential ?

8.3 Electric Potential and Potential Energy:

We have studied earlier that the potential energy of a system is the stored energy that depends upon the relative positions of its constituents. Electrostatic potential energy is the work done against the electrostatic forces to achieve a certain configuration of charges in a given system. Since every system tries to attain the lowest potential energy, work is always required to be done to change the configuration.

We know that like charges repel and unlike charges attract each other. A charge exerts a force on any other charge in its vicinity. Some work is always done to move a charge in the presence of another charge. Thus, potential energy arises from any collection of charges. Consider a positive charge Q fixed at some point in space. For bringing any other positive charge close to it, work is necessary. This work is equal to the change in the potential energy of their system.

Thus, work done against a electrostatic force = Increase in the potential energy of the system.

$$\therefore \vec{F} \cdot d\vec{r} = dU,$$

where dU is the increase in potential energy when the charge is displaced through $d\vec{r}$ and \vec{F} is the force exerted on the charge.

Expression for potential energy:

Let us consider the electrostatic field due to a source charge $+Q$ placed at the origin O . Let a small charge $+q_0$ be brought from point A to point B at respective distances r_1 and r_2 from O , against the repulsive forces on it.

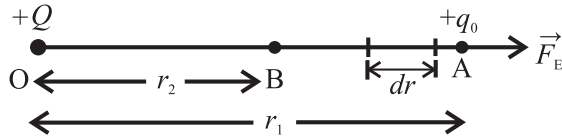

Fig. 8.5: Charge $+q_0$ displaced by dr towards charge $+Q$.

Work done against the electrostatic force \vec{F}_E , in displacing the charge q_0 through a small displacement $d\vec{r}$ appears as an increase in the potential energy of the system.

$$dU = \vec{F}_E \cdot d\vec{r} = -F_E \cdot dr$$

Negative sign appears because the displacement $d\vec{r}$ is against the electrostatic force \vec{F}_E .

For the displacement of the charge from the initial position A to the final position B , the change in potential energy ΔU , can be obtained by integrating dU

$$\therefore \Delta U = \int_{r_1}^{r_2} dU = \int_{r_1}^{r_2} -\vec{F}_E \cdot d\vec{r}$$

The electrostatic force (Coulomb force) between the two charges separated by distance r is

$$\vec{F}_E = -\left(\frac{1}{4\pi\epsilon_0}\right) \frac{Qq_0}{r^2} \hat{r}$$

where \hat{r} is the unit vector in the direction of \vec{r} . Negative sign shows \vec{r} and \vec{F}_E are oppositely directed.

\therefore For a system of two point charge,

$$\Delta U = \int_{r_1}^{r_2} dU = \int_{r_1}^{r_2} -\left(\frac{1}{4\pi\epsilon_0}\right) \frac{Qq_0}{r^2} \hat{r} \cdot d\vec{r}$$

$$\begin{aligned} \therefore \Delta U &= -\left(\frac{1}{4\pi\epsilon_0}\right) Qq_0 \left(\frac{-1}{r}\right)_{r_1}^{r_2} \\ &= \left(\frac{1}{4\pi\epsilon_0}\right) Qq_0 \left(\frac{1}{r_2} - \frac{1}{r_1}\right) \end{aligned}$$

The change in the potential energy depends only upon the end points and is independent of the actual path taken by the charge. The change in potential energy is equal to the work done W_{AB} against the electrostatic force.

$$W_{AB} = \Delta U = \left(\frac{1}{4\pi\epsilon_0}\right) Qq_0 \left(\frac{1}{r_2} - \frac{1}{r_1}\right)$$

So far we have defined/calculated the change in the potential energy for system of charges. It is convenient to choose infinity to be the point of zero potential energy as the electrostatic force is zero at $r = \infty$.

Thus, the potential energy U of the system of two point charges q_1 and q_2 separated by r can be obtained from the above equation by using $r_1 = \infty$ and $r_2 = r$. It is then given by

$$U(r) = \left(\frac{1}{4\pi\epsilon_0}\right) \left(\frac{q_1 q_2}{r}\right) \quad \text{--- (8.9)}$$

Units of potential energy :

SI unit= joule (J)

“One joule is the energy stored in moving a charge of 1C through a potential difference of 1 volt. Another convenient unit of energy is electron volt (eV), which is the change in the kinetic energy of an electron while crossing two points maintained at a potential difference of 1 volt.”

$$1 \text{ eV} = 1.6 \times 10^{-19} \text{ joule}$$

Other related units are:

$$1 \text{ meV} = 1.6 \times 10^{-22} \text{ J}$$

$$1 \text{ keV} = 1.6 \times 10^{-16} \text{ J}$$

Concept of Potential:

Equation (8.9) gives the potential energy of a two particle system at a distance r from each other.

$$\begin{aligned} U(r) &= \left(\frac{1}{4\pi\epsilon_0 r} \right) \left(\frac{q_1 q_2}{r} \right) \\ &= \left(\frac{q_1}{4\pi\epsilon_0 r} \right) q_2 = \left(\frac{q_2}{4\pi\epsilon_0 r} \right) q_1 \end{aligned}$$

The quantity $V(r) \equiv \left(\frac{q}{4\pi\epsilon_0 r} \right)$ depends upon the charge q and location of a point at a distance r from it. This is defined as the electrostatic potential of the charge q at a distance r from it. In terms of potential, we can write the potential energy of the 'two charge' system as $U(r) = V_1(r)q_2 = V_2(r)q_1$, where $V_1(r)$ and $V_2(r)$ are the respective potentials of charges q_1 and q_2 at distance r from either.

\therefore Electrostatic potential energy (U) = electric potential $V \times$ charge q

Or, Electrostatic Potential (V) = Electrostatic Potential Energy per unit charge.

i.e., $V = U/q$

Electrostatic potential difference between any two points in an electric field can be written as $V_2 - V_1 = \frac{U_2 - U_1}{q} = \frac{dW}{q} =$ work done dW (or change in PE) per unit charge to move the charge from point 2 to point 1.

Relation between electric field and electric potential:

Consider the electric field produced by a charge $+q$ kept at point O (see Fig. 8.6). Let us calculate the work done to move a unit positive charge from point M to point N which is at a small distance dx from M. The direction of the electric field at M is along \overline{OM} . Thus the force acting on the unit positive charge is along \overline{OM} . The work done $= dW = -Fdx = -Edx$. The negative sign indicates that we are moving the charge against the force acting on it. As it is

the work done on a unit positive charge, $dW = dV =$ difference in potential between M and N.

$$\therefore dV = -Edx$$

$$E = -\frac{dV}{dx}$$

Thus the electric field at a point in an electric field is the negative of the potential gradient at that point.

Zero potential:

The nature of potential is such that its zero point is arbitrary. This does not mean that the choice of zero point is insignificant. Once the zero point of the potential is set, then every potential is measured with respect to that reference. The zero potential is set conveniently.

In case of a point charge or localised collection of charges, the zero point is set at infinity. For electrical circuits the earth is usually taken to be at zero potential.

Thus the potential at a point A in an electric field is the amount of work done to bring a unit positive charge from infinity to point A.

Example 8.4: Potential at a point A in space is given as $4 \times 10^5 \text{ V}$.

- Find the work done in bringing a charge of $3 \mu\text{C}$ from infinity to the point A.
- Does the answer depend on the path along which the charge is brought?

Solution : Given

Potential (V) at the point A = $4 \times 10^5 \text{ V}$

Charge $q_0 = 3 \mu\text{C} = 3 \times 10^{-6} \text{ C}$

- Work done in bringing the charge from infinity to the point A is

$$\begin{aligned} W_\infty &= q_0 V \\ &= 3 \times 10^{-6} \times 4 \times 10^5 \\ &= 12 \times 10^{-1} \end{aligned}$$

$$W_\infty = 1.2 \text{ J}$$

- No, the work done is independent of the path.

Example 8.5 If 120 J of work is done in carrying a charge of 6 C from a place where the potential is 10 volt to another place

where the potential is V , find V

Solution: Given : $W_{AB} = 120 \text{ J}$, $q_0 = 6 \text{ C}$,
 $V_A = 10 \text{ V}$, $V_B = V$

As $V_B - V_A = \frac{W_{AB}}{q_0}$

$$V - (10) = \frac{120}{6}$$

$$V - (10) = 20$$

$$\therefore V = 30 \text{ volt}$$

8.4 Electric Potential due to a Point Charge, a Dipole and a System of Charges:

a) Electric potential due to a point charge:

Here, we shall derive an expression for the electrostatic potential due to a point charge.

Figure 8.6 shows a point charge $+q$, located at point O. We need to determine its potential at a point A, at a distance r from it.

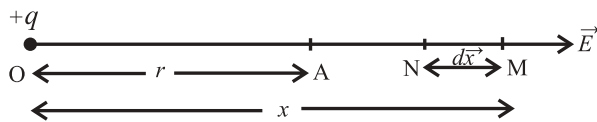

Fig. 8.6: Electric potential due to a point charge.

As seen above the electric potential at a point A is the amount of work done per unit positive charge, which is displaced from ∞ to point A. As the work done is independent of the path, we choose a convenient path along the line extending OA to ∞ .

Let M be an intermediate point on this path where $OM = x$. The electrostatic force on a unit positive charge at M is of magnitude

$$F = \frac{1}{4\pi\epsilon_0} \times \frac{q}{x^2} \quad \text{--- (8.10)}$$

It is directed away from O, along OM. For infinitesimal displacement dx from M to N, the amount of work done is given by

$$\therefore dW = - Fdx \quad \text{--- (8.11)}$$

The negative sign appears as the displacement is directed opposite to that of the force.

\therefore Total work done in displacing the unit positive charge from ∞ to point A is given by

$$W = \int_{\infty}^r - Fdx = \int_{\infty}^r - \frac{1}{4\pi\epsilon_0} \frac{q}{x^2} dx$$

$$\begin{aligned} &= \frac{-q}{4\pi\epsilon_0} \int_{\infty}^r x^{-2} dx \\ &= \frac{-q}{4\pi\epsilon_0} \left[\frac{-1}{x} \right]_{\infty}^r \quad \left(\because \int x^{-2} dx = \frac{-1}{x} \right) \\ &= \frac{q}{4\pi\epsilon_0} \left[\frac{1}{r} - \frac{1}{\infty} \right] \quad \left(\because \frac{1}{\infty} = 0 \right) \end{aligned}$$

$$W = \frac{q}{4\pi\epsilon_0 r} \quad \text{--- (8.12)}$$

By definition this is the electrostatic potential at A due to charge q .

$$\therefore V = W = \frac{q}{4\pi\epsilon_0 r} \quad \text{--- (8.13)}$$

A positively charged particle produces a positive electric potential and a negatively charged particle produces a negative electric potential

$$\text{At } r = \infty, V = \frac{q}{\infty} = 0$$

This shows that the electrostatics potential is zero at infinity.

Equation (8.13) shows that for any point at a distance r from the point charge q , the value of V is the same and is independent of the direction of r . Hence electrostatic potential due to a single charge is spherically symmetric.

Figure 8.7 shows how electric potential ($V \propto \frac{1}{r}$) and electric field ($E \propto \frac{1}{r^2}$) vary with r , the distance from the charge.

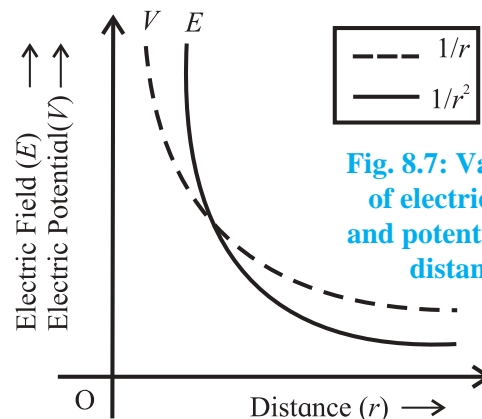

Fig. 8.7: Variation of electric field and potential with distance



Remember this

Due to a single charge at a distance r , Force (F) $\propto 1/r^2$, Electric field (E) $\propto 1/r^2$ but Potential (V) $\propto 1/r$.

Example 8.6: A wire is bent in a circle of radius 10 cm. It is given a charge of $250\mu\text{C}$ which spreads on it uniformly. What is the electric potential at the centre ?

Solution : Given :

$$q = 250 \mu\text{C} = 250 \times 10^{-6} \text{ C}$$

$$R = 10 \text{ cm} = 10^{-1} \text{ m}$$

$$V = ?$$

As $V = \frac{1}{4\pi\epsilon_0} \frac{q}{r} = \frac{9 \times 10^9 \times 250 \times 10^{-6}}{10^{-1}}$

$$= 2.25 \times 10^7 \text{ volt}$$

b) Electric potential due to an electric dipole:

We have studied electric and magnetic dipoles in XIth Std. Figure 8.8 shows an electric dipole AB consisting of two charges $+q$ and $-q$ separated by a finite distance $2l$. Its dipole moment is \vec{p} , of magnitude $p = q \times 2l$, directed from $-q$ to $+q$. The line joining the centres of the two charges is called dipole axis. A straight line drawn perpendicular to the axis and passing through centre O of the electric dipole is called equator of dipole.

In order to determine the electric potential due to a dipole, let the origin be at the centre (O) of the dipole.

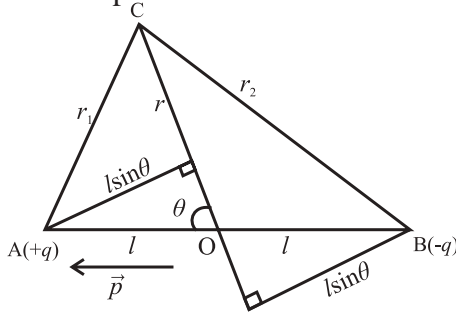

Fig. 8.8: Electric potential due to an electric dipole.

Let C be any point near the electric dipole at a distance r from the centre O inclined at an angle θ with axis of the dipole. r_1 and r_2 are the distances of point C from charges $+q$ and $-q$, respectively.

Potential at C due to charge $+q$ at A is,

$$V_1 = \frac{+q}{4\pi\epsilon_0 r_1}$$

Potential at C due to charge $-q$ at B is,

$$V_2 = \frac{-q}{4\pi\epsilon_0 r_2}$$

The electrostatic potential is the work done by the electric field per unit charge, $\left(V = \frac{W}{Q} \right)$.

The potential at C due to the dipole is,

$$V_C = V_1 + V_2 = \frac{q}{4\pi\epsilon_0} \left[\frac{1}{r_1} - \frac{1}{r_2} \right]$$

By geometry,

$$r_1^2 = r^2 + l^2 - 2rl \cos \theta$$

$$r_2^2 = r^2 + l^2 + 2rl \cos \theta$$

$$r_1 = r \left(1 + \frac{l^2}{r^2} - 2 \frac{l}{r} \cos \theta \right)^{1/2}$$

$$r_2 = r \left(1 + \frac{l^2}{r^2} + 2 \frac{l}{r} \cos \theta \right)^{1/2}$$

For a short dipole, $2l \ll r$ and

If $r \gg l$ $\frac{l}{r}$ is small $\therefore \frac{l^2}{r^2}$ can be neglected

$$\therefore r_1 = r \left(1 - 2 \frac{l}{r} \cos \theta \right)^{1/2}$$

$$r_2 = r \left(1 + \frac{2l}{r} \cos \theta \right)^{1/2}$$

$$\therefore r_1 = r \left(1 - \frac{2l}{r} \cos \theta \right)^{1/2}$$

$$r_2 = r \left(1 + \frac{2l}{r} \cos \theta \right)^{1/2}$$

$$\therefore \frac{1}{r_1} = \frac{1}{r} \left(1 - \frac{2l}{r} \cos \theta \right)^{-1/2} \text{ and}$$

$$\frac{1}{r_2} = \frac{1}{r} \left(1 + \frac{2l}{r} \cos \theta \right)^{-1/2}$$

$$\therefore V_C = V_1 + V_2 = \frac{q}{4\pi\epsilon_0} \left[\frac{1}{r} \left(1 - \frac{2l \cos \theta}{r} \right)^{-1/2} - \frac{1}{r} \left(1 + \frac{2l \cos \theta}{r} \right)^{-1/2} \right]$$

Using binomial expansion, $(1+x)^n = 1 + nx$, $x \ll 1$ and retaining terms up to the first order of $\frac{l}{r}$ only, we get

$$V_C = \frac{q}{4\pi\epsilon_0} \frac{1}{r} \left[\left(1 + \frac{\ell}{r} \cos \theta \right) - \left(1 - \frac{\ell}{r} \cos \theta \right) \right]$$

$$= \frac{q}{4\pi\epsilon_0 r} \left[1 + \frac{\ell}{r} \cos \theta - 1 + \frac{\ell}{r} \cos \theta \right]$$

$$= \frac{q}{4\pi\epsilon_0 r} \left[\frac{2\ell}{r} \cos \theta \right]$$

$$\therefore V_C = \frac{1}{4\pi\epsilon_0} \frac{p \cos \theta}{r^2} \quad (\because p = q \times 2\ell)$$

Electric potential at C, can also be expressed as,

$$V_C = \frac{1}{4\pi\epsilon_0} \frac{\vec{p} \cdot \vec{r}}{r^3}$$

$$V_C = \frac{1}{4\pi\epsilon_0} \frac{\vec{p} \cdot \hat{r}}{r^2}, \quad \left(\hat{r} = \frac{\vec{r}}{r} \right)$$

where \hat{r} is a unit vector along the position vector, $\vec{OC} = \hat{r}$

i) Potential at an axial point, $\theta = 0^\circ$ (towards +q) or 180° (towards -q)

$$V_{axial} = \frac{\pm 1}{4\pi\epsilon_0} \frac{p}{r^2}$$

i.e. This is the maximum value of the potential.

ii) Potential at an equatorial point, $\theta = 90^\circ$ and $V = 0$

Hence, the potential at any point on the equatorial line of a dipole is zero. This is the minimum value of the magnitude of the potential of a dipole.

Thus the plane perpendicular to the line between the charges at the midpoint is an equipotential plane with potential zero. The work done to move a charge anywhere in this plane (potential difference being zero) will be zero.

Example 8.7: A short electric dipole has dipole moment of $1 \times 10^{-9} \text{ C m}$. Determine the electric potential due to the dipole at a point distance 0.3 m from the centre of the dipole situated

- a) on the axial line
- b) on the equatorial line
- c) on a line making an angle of 60° with the dipole axis.

Solution: Given

$$p = 1 \times 10^{-9} \text{ Cm}$$

$$r = 0.3 \text{ m}$$

a) Potential at a point on the axial line

$$V = \frac{1}{4\pi\epsilon_0} \frac{p}{r^2} = \frac{9 \times 10^9 \times 1 \times 10^{-9}}{(0.3)^2} = 100 \text{ volt}$$

b) Potential at a point on the equatorial line = 0

c) Potential at a point on a line making an angle of 60° with the dipole axis is

$$V = \frac{1}{4\pi\epsilon_0} \frac{p \cos \theta}{r^2} = \frac{9 \times 10^9 \times 1 \times 10^{-9} \cos 60^\circ}{(0.3)^2}$$

$$= 50 \text{ volt}$$

c) Electrostatics potential due to a system of charges:

We now extend the analysis to a system of charges.

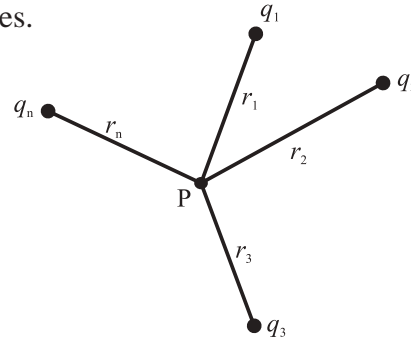

Fig. 8.9: System of charges.

Consider a system of charges q_1, q_2, \dots, q_n at distances r_1, r_2, \dots, r_n respectively from point P. The potential V_1 at P due to the charge q_1 is

$$V_1 = \frac{1}{4\pi\epsilon_0} \frac{q_1}{r_1}$$

Similarly the potentials V_2, V_3, \dots, V_n at P due to the individual charges q_2, q_3, \dots, q_n are given by

$$V_2 = \frac{1}{4\pi\epsilon_0} \frac{q_2}{r_2}, \quad V_3 = \frac{1}{4\pi\epsilon_0} \frac{q_3}{r_3}, \quad V_n = \frac{1}{4\pi\epsilon_0} \frac{q_n}{r_n}$$

By the superposition principle, the potential V at P due to the system of charges is the algebraic sum of the potentials due to the individual charges.

$$\therefore V = V_1 + V_2 + \dots + V_n$$

$$= \frac{1}{4\pi\epsilon_0} \left(\frac{q_1}{r_1} + \frac{q_2}{r_2} + \dots + \frac{q_n}{r_n} \right)$$

$$\text{Or, } V = \frac{1}{4\pi\epsilon_0} \sum_{i=1}^n \frac{q_i}{r_i}$$

For a continuous charge distribution, summation should be replaced by integration.



Use your brain power

Is electrostatic potential necessarily zero at a point where electric field strength is zero? Justify.

Example 8.8: Two charges $5 \times 10^{-8} \text{ C}$ and $-3 \times 10^{-8} \text{ C}$ are located 16 cm apart. At what point (s) on the line joining the two charges is the electric potential zero? Take the potential at infinity to be zero.

Solution : As shown below, suppose the two point charges are placed on x - axis with the positive charge located at the origin O.

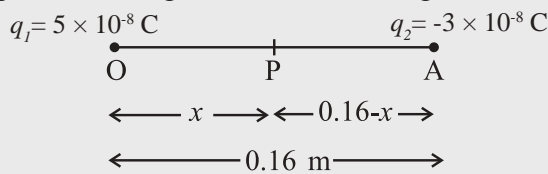

Let the potential be zero at the point P and $OP = x$. For $x < 0$ (i.e. to the left of O), the potentials of the two charges cannot add up to zero. Clearly, x must be positive. If x lies between O and A, then

$V_1 + V_2 = 0$, where V_1 and V_2 are the potentials at points O and A, respectively.

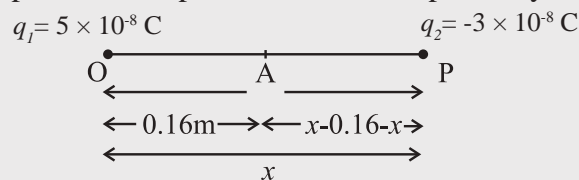

$$\frac{1}{4\pi\epsilon_0} \left[\frac{q_1}{x} + \frac{q_2}{0.16-x} \right] = 0$$

$$9 \times 10^9 \left[\frac{5 \times 10^{-8}}{x} - \frac{3 \times 10^{-8}}{0.16-x} \right] = 0$$

$$\Rightarrow 9 \times 10^9 \times 10^{-8} \left[\frac{5}{x} - \frac{3}{0.16-x} \right] = 0$$

$$\Rightarrow \frac{5}{x} - \frac{3}{0.16-x} = 0$$

$$\therefore x = 0.10 \text{ m, } x = 10 \text{ cm}$$

The other possibility is that x may also lie on extended OA.

As $V_1 + V_2 = 0$

$$\frac{1}{4\pi\epsilon_0} \left[\frac{q_1}{x} + \frac{q_2}{x-0.16} \right] = 0$$

$$9 \times 10^9 \left[\frac{5 \times 10^{-8}}{x} - \frac{3 \times 10^{-8}}{x-0.16} \right] = 0$$

$$\therefore x = 0.40 \text{ m, } x = 40 \text{ cm}$$

8.5 Equipotential Surfaces:

An equipotential surface is that surface, at every point of which the electric potential is the same. We know that,

The potential (V) for a single charge q is given by $V = \frac{1}{4\pi\epsilon_0} \frac{q}{r}$

If r is constant then V will be constant. Hence, equipotential surfaces of single point charge are concentric spherical surfaces centered at the charge. For a line charge, the shape of equipotential surface is cylindrical.

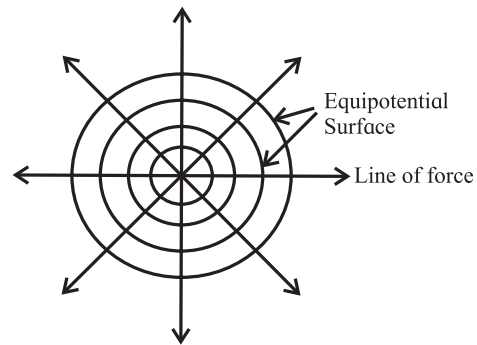

Fig. 8.10 : Equipotential surfaces.

Equipotential surfaces can be drawn through any region in which there is an electric field.

By definition the potential difference between two points P and Q is the work done per unit positive charge displaced from Q to P.

$$\therefore V_P - V_Q = W_{QP}$$

If points P and Q lie on an equipotential surface, $V_P = V_Q$.

$$\therefore W_{QP} = 0$$

Thus, no work is required to move a test charge along an equipotential surface.

a) If dx is the small distance over the equipotential surface through which unit positive charge is carried then

$$dW = \vec{E} \cdot d\vec{x} = E dx \cos \theta = 0$$

$\therefore \cos \theta = 0$ or $\theta = 90^\circ$

i.e. $\vec{E} \perp d\vec{x}$ as shown in Fig. 8.11

Hence electric field intensity \vec{E} is always normal to the equipotential surface i.e., for any charge distribution, the equipotential surface through a point is normal to the electric field at that point.

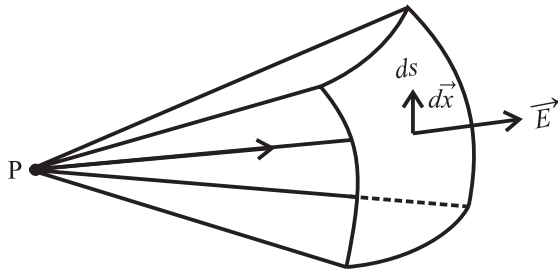

Fig. 8.11: Equipotential surface \perp to \vec{E}

b) If the field is not normal, it would have a nonzero component along the surface. So to move a test charge against this component work would have to be done. But by the definition of equipotential surfaces, there is no potential difference between any two points on an equipotential surface and hence no work is required to displace the charge on the surface. Therefore, we can conclude that the electrostatic field must be normal to the equipotential surface at every point, and vice versa.

Do you know?

Equipotential surfaces do not intersect each other as it gives two directions of electric fields at intersecting point which is not possible.

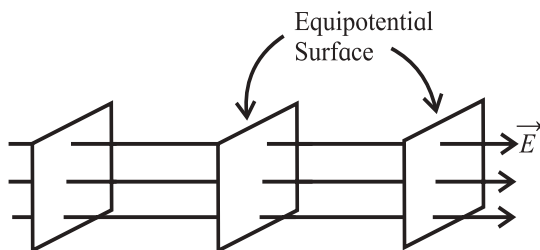

Fig. 8.12: Equipotential surfaces for a uniform electric field.

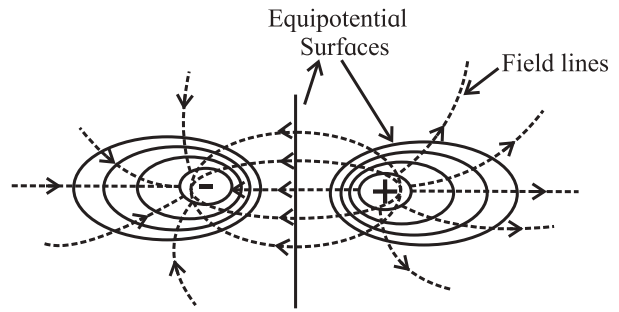

Fig. 8.13: Equipotential surfaces for a dipole.

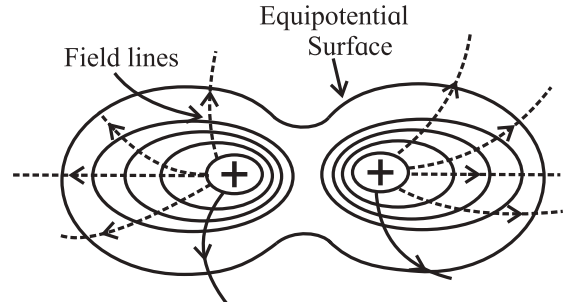

Fig. 8.14: Equipotential surfaces for two identical positive charges.

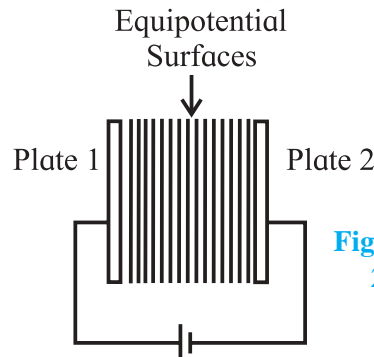
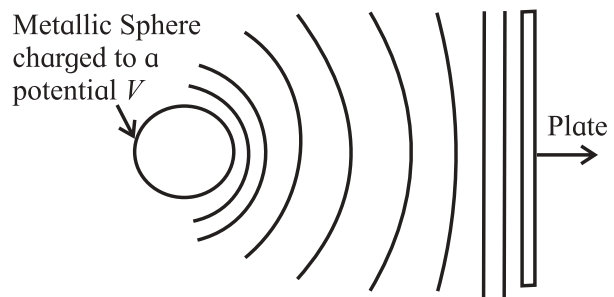

Fig. 8.15: (a) Between 2 plane metallic sheets.



(b) When one of the sheet is replaced by a charged metallic sphere.

Like the lines of force, the equipotential surface give a visual picture of both the direction and the magnitude of electric field in a region of space.

Example 8.9: A small particle carrying a negative charge of 1.6×10^{-19} C is suspended in equilibrium between two horizontal metal plates 10 cm apart having a potential

difference of 4000 V across them. Find the mass of the particle.

Solution: Given :

$$q = 1.6 \times 10^{-19} \text{ C}$$

$$dx = 10 \text{ cm} = 10 \times 10^{-2} \text{ m} = 10^{-1} \text{ m}$$

$$dV = 4000 \text{ V}$$

$$E = \frac{-dV}{dx} = \frac{-4000}{10^{-1}}$$

$$= -4 \times 10^4 \text{ Vm}^{-1}$$

As the charged particle remain suspended in equilibrium,

$$F = mg = qE$$

$$\therefore m = \frac{qE}{g} = \frac{(-1.6 \times 10^{-19})(-4 \times 10^4)}{9.8}$$

$$= 0.653 \times 10^{-15} \text{ kg}$$

$$m = 6.53 \times 10^{-16} \text{ kg}$$

8.6 Electrical Energy of Two Point Charges and of a Dipole in an Electrostatic Field:

When two like charges lie infinite distance apart, their potential energy is zero because no work has to done in moving one charge at infinite distance from the other. But when they are brought closer to one another, work has to be done against the force of repulsion. As electrostatic force is conservative, this work gets stored as the potential energy of the two charges. **Electrostatic potential energy of a system of point charges is defined as the total amount of work done to assemble the system of charges by bringing them from infinity to their present locations.**

a) Potential energy of a system of 2 point charges:

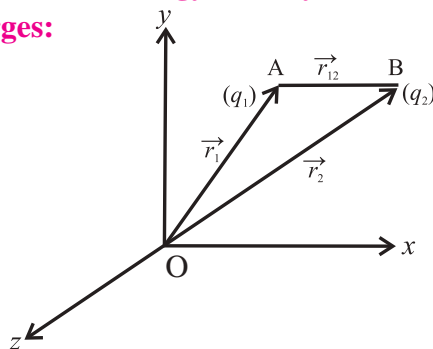

Fig. 8.16: System of two point charges.

Let us consider 2 charges q_1 and q_2 with position vectors r_1 and r_2 relative to some origin (O).

To calculate the electric potential energy of the two charge system, we assume that the two charges q_1 and q_2 are initially at infinity. We then determine the work done in bringing the charges to the given location by an external agency.

In bringing the first charge q_1 to position A (\vec{r}_1), no work is done because there is no external field against which work needs to be done as charge q_2 is still at infinity i.e., $W_1 = 0$. This charge produces a potential in space given by

$$V_1 = \frac{1}{4\pi\epsilon_0} \frac{q_1}{r_1} \quad \text{--- (8.14)}$$

Where r_1 is the distance of point A from the origin.

When we bring charge q_2 from infinity to B (\vec{r}_2) at a distance r_{12} , from q_1 , work done is $W_2 = (\text{potential at B due to charge } q_1) \times q_2$

$$= \frac{q_1}{4\pi\epsilon_0 r_{12}} \times q_2, \text{ (where } AB = r_{12}) \quad \text{--- (8.15)}$$

This work done in bringing the two charges to their respective locations is stored as the potential energy of the configuration of two charges.

$$\therefore U = \frac{1}{4\pi\epsilon_0} \frac{q_1 q_2}{r_{12}} \quad \text{--- (8.16)}$$

Equation (8.16) can be generalised for a system of any number of point charges.

Example 8.10: Two charges of magnitude 5 nC and -2 nC are placed at points (2 cm, 0, 0) and (20 cm, 0, 0) in a region of space, where there is no other external field. Find the electrostatic potential energy of the system.

Solution : Given

$$q_1 = 5 \text{ nC} = 5 \times 10^{-9} \text{ C}$$

$$q_2 = -2 \text{ nC} = -2 \times 10^{-9} \text{ C}$$

$$r = (20 - 2) \text{ cm} = 18 \text{ cm} = 18 \times 10^{-2} \text{ m}$$

$$U = \frac{1}{4\pi\epsilon_0} \frac{q_1 q_2}{r}$$

$$= \frac{9 \times 10^9 \times 5 \times 10^{-9} \times -2 \times 10^{-9}}{18 \times 10^{-2}}$$

$$= -5 \times 10^{-7} \text{ J} = -0.5 \times 10^{-6} \text{ J} = -0.5 \text{ } \mu\text{J}$$

b) Potential energy for a system of N point charges:

Equation (8.16) gives an expression for potential energy for a system of two charges. We now analyse the situation for a system of N point charges.

In bringing a charge q_3 from ∞ to C (\vec{r}_3) work has to be done against electrostatic forces of both q_1 and q_2

$$\begin{aligned} \therefore W_3 &= (\text{potential at C due to } q_1 \text{ and } q_2) \times q_3 \\ &= \frac{1}{4\pi\epsilon_0} \left[\frac{q_1}{r_{13}} + \frac{q_2}{r_{23}} \right] \times q_3 \\ &= \frac{1}{4\pi\epsilon_0} \left[\frac{q_1 q_3}{r_{13}} + \frac{q_2 q_3}{r_{23}} \right] \end{aligned}$$

Similarly in bringing a charge q_4 from ∞ to D (\vec{r}_4) work has to be done against electrostatic forces of $q_1, q_2,$ and q_3

$$W_4 = \frac{1}{4\pi\epsilon_0} \left[\frac{q_1 q_4}{r_{14}} + \frac{q_2 q_4}{r_{24}} + \frac{q_3 q_4}{r_{34}} \right]$$

Proceeding in the same way, we can write the electrostatic potential energy of a system of N point charges at $\vec{r}_1, \vec{r}_2, \dots, \vec{r}_N$ as

$$U = \frac{1}{4\pi\epsilon_0} \sum_{\text{all pairs}} \frac{q_j q_k}{r_{jk}}$$

Example 8.11: Calculate the electrostatic potential energy of the system of charges shown in the figure.

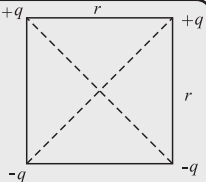

Solution : Taking zero of potential energy at ∞ , we get potential energy (PE) of the system of charges

$$\begin{aligned} \text{PE} &= \frac{1}{4\pi\epsilon_0} \sum \frac{q_j q_k}{r_{jk}} \\ &= \frac{1}{4\pi\epsilon_0} \left[\frac{qq}{r} + \frac{q(-q)}{r} + \frac{(-q)(-q)}{r} + \frac{(-q)(+q)}{r} + \frac{q(-q)}{r\sqrt{2}} + \frac{q(-q)}{r\sqrt{2}} \right] \\ &= \frac{1}{4\pi\epsilon_0} \left[\frac{q^2}{r} - \frac{q^2}{r} + \frac{q^2}{r} - \frac{q^2}{r} - \frac{q^2}{r\sqrt{2}} - \frac{q^2}{r\sqrt{2}} \right] \\ &= \frac{1}{4\pi\epsilon_0} \left[\frac{-2q^2}{r\sqrt{2}} \right] = \left[\frac{-\sqrt{2}q^2}{4\pi\epsilon_0 r} \right] \end{aligned}$$

(c) Potential energy of a single charge in an external field:

Above, we have obtained an expression for potential energy of a system of charges when the source of the electric field, i.e., charges and their locations, were specified.

In this section, we determine the potential energy of a charge (or charges) in an external field \vec{E} which is not produced by the given charge (or charges) whose potential energy we wish to calculate. The external sources could be known, unknown or unspecified, but what is known is the electric field E or the electrostatic potential V due to the external sources.

Here we assume that the external field is not affected by the charge q , if q is very small. The external electric field E and the corresponding external potential V may vary from point to point.

If $V(\vec{r})$ is the external potential at any point P having position vector \vec{r} , then by definition, work done in bringing a unit positive charge from ∞ to the point P is equal to V .

\therefore Work done in bringing a charge q , from ∞ to the given point in the external field is $qV(\vec{r})$.

This work is stored in the form of potential energy of a system of charge q .

\therefore PE of a system of a single charge q at \vec{r} in an external field is given by

$$PE = qV(\vec{r}) \quad \text{--- (8.17)}$$

(d) Potential energy of a system of two charges in an external field:

In order to find the potential energy of a system of two charges q_1 and q_2 located at r_1 and r_2 respectively in an external field, we calculate the work done in bringing the charge q_1 from ∞ to r_1 .

$$\begin{aligned} \text{From (8.17), in the said process work done} \\ = q_1 V(\vec{r}_1) \quad \text{--- (8.18)} \end{aligned}$$

To bring the charge q_2 to r_2 , the work is done not only against the external field E but also against the field due to q_1 .

\therefore Work done on q_2 against the external field $= q_2 V(\vec{r}_2)$ and Work done on q_2 against the field due to $q_1 = \frac{q_1 q_2}{4\pi\epsilon_0 r_{12}}$,

where r_{12} = distance between q_1 and q_2 .

By the Principle of superposition for fields, we add up the work done on q_2 against the two fields.

$$\therefore \text{Work done in bringing } q_2 \text{ to } r_2 = q_2 V(\vec{r}_2) + \frac{q_1 q_2}{4\pi\epsilon_0 r_{12}} \quad \dots (8.19)$$

Thus from (8.18) and (8.19) potential energy of the system

= Total work done in assembling the configuration

$$= q_1 V(\vec{r}_1) + q_2 V(\vec{r}_2) + \frac{q_1 q_2}{4\pi\epsilon_0 r_{12}}$$

Example 8.12: Two charged particles having equal charge of 3×10^{-5} C each are brought from infinity to a separation of 30 cm. Find the increase in electrostatic potential energy during the process.

Solution : Taking the potential energy (PE) at ∞ to be zero,

Increase in PE = present PE

$$V = \frac{q_1 q_2}{4\pi\epsilon_0 r} = \frac{9 \times 10^9 \times (3 \times 10^{-5})^2}{0.3} = \frac{9 \times 9 \times 10^9 \times 10^{-10}}{3 \times 10^{-1}} = \frac{81}{3} = 27 \text{ J}$$

Example 8.13:

a) Determine the electrostatic potential energy of a system consisting of two charges $-2 \mu\text{C}$ and $+4 \mu\text{C}$ (with no external field) placed at $(-8 \text{ cm}, 0, 0)$ and $(+8 \text{ cm}, 0, 0)$ respectively.

b) Suppose the same system of charges is now placed in an external electric field $E = A (1/r^2)$, where $A = 8 \times 10^5 \text{ cm}^{-2}$, what would be the electrostatic potential energy of the configuration

Solution: Given :

$$q_1 = -2 \mu\text{C} = -2 \times 10^{-6} \text{ C}, \quad r_1 = 0.08 \text{ cm}$$

$$q_2 = +4 \mu\text{C} = +4 \times 10^{-6} \text{ C}, \quad r_2 = 0.08 \text{ cm}$$

$$r = 16 \text{ cm} = 0.16 \text{ m}$$

a) Electrostatic potential energy of the system of two charges is

$$V = \frac{1}{4\pi\epsilon_0} \frac{q_1 q_2}{r} = \frac{9 \times 10^9 \times (-2) \times 10^{-6} \times 4 \times 10^{-6}}{0.16} = 0.45 \text{ J}$$

b) In the electric field, total potential energy (PE) =

$$\text{(PE)} = \frac{q_1 q_2}{4\pi\epsilon_0 r} + q_1 V(\vec{r}_1) + q_2 V(\vec{r}_2)$$

$$E = \frac{-dV}{dr} \therefore V = \int -E dr = \int \frac{-A}{r^2} dr, V = \frac{A}{r}$$

$$\therefore \text{Total PE} = \frac{q_1 q_2}{4\pi\epsilon_0 r} + \frac{A q_1}{r_1} + \frac{A q_2}{r_2}$$

$$= -0.45 + \frac{8 \times 10^5 \times (-2 \times 10^{-6})}{0.08} + \frac{8 \times 10^5 \times (4 \times 10^{-6})}{0.08}$$

$$= -0.45 - 20 + 40$$

$$= 19.55 \text{ J}$$

(e) Potential energy of a dipole in an external field:

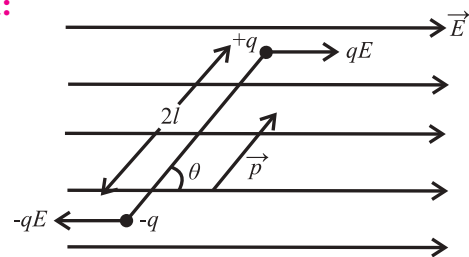

Fig. 8.17 : Couple acting on a dipole.

Consider a dipole with charges $-q$ and $+q$ separated by a finite distance 2ℓ , placed in a uniform electric field \vec{E} . It experiences a torque $\vec{\tau}$ which tends to rotate it.

$$\vec{\tau} = \vec{p} \times \vec{E} \text{ or } \tau = pE \sin \theta$$

In order to neutralize this torque, let us assume an external torque $\vec{\tau}_{ext}$ is applied, which rotates it in the plane of the paper from angle θ_0 to angle θ , without angular acceleration and at an infinitesimal angular speed. Work done by the external torque

$$W = \int_{\theta_0}^{\theta} \tau_{ext}(\theta) d\theta = \int_{\theta_0}^{\theta} pE \sin \theta d\theta$$

$$\begin{aligned}
 &= pE [-\cos \theta]_{\theta_0}^{\theta} \\
 &= pE [-\cos \theta - (-\cos \theta_0)] \\
 &= pE [-\cos \theta + \cos \theta_0] \\
 &= pE [\cos \theta_0 - \cos \theta]
 \end{aligned}$$

This work done is stored as the potential energy of the system in the position when the dipole makes an angle θ with the electric field. The zero potential energy can be chosen as per convenience. We can choose $U(\theta_0) = 0$, giving

$$\therefore U(\theta) - U(\theta_0) = pE(\cos \theta_0 - \cos \theta)$$

a) If initially the dipole is perpendicular to the field \vec{E} i.e., $\theta_0 = \frac{\pi}{2}$ then

$$\begin{aligned}
 U(\theta) &= pE \left(\cos \frac{\pi}{2} - \cos \theta \right) \\
 &= -pE \cos \theta \\
 U(\theta) &= -\vec{p} \cdot \vec{E}
 \end{aligned}$$

b) If initially the dipole is parallel to the field \vec{E} then $\theta_0 = 0$

$$\begin{aligned}
 U(\theta) &= pE(\cos 0 - \cos \theta) \\
 U(\theta) &= pE(1 - \cos \theta)
 \end{aligned}$$

Example 8.14: An electric dipole consists of two opposite charges each of magnitude $1\mu\text{C}$ separated by 2 cm. The dipole is placed in an external electric field of 10^5 N C^{-1} .

Find:

- (i) The maximum torque exerted by the field on the dipole
- (ii) The work the external agent will have to do in turning the dipole through 180° starting from the position $\theta = 0^\circ$

Solution: Given :

$$\begin{aligned}
 p &= q \times 2l = 10^{-6} \times 2 \times 10^{-2} = 2 \times 10^{-8} \text{ cm} \\
 E &= 10^5 \text{ NC}^{-1}
 \end{aligned}$$

$$(i) \tau_{\max} = pE \sin 90^\circ = 2 \times 10^{-8} \times 10^5 \times 1 = 2 \times 10^{-3} \text{ Nm}$$

$$\begin{aligned}
 (ii) W &= pE(\cos \theta_1 - \cos \theta_2) \\
 &= 2 \times 10^{-8} \times 10^5 (\cos 0^\circ - \cos 180^\circ) \\
 &= 2 \times 10^{-3} (1 + 1) = 4 \times 10^{-3} \text{ J}
 \end{aligned}$$

8.7 Conductors and Insulators, Free Charges and Bound Charges Inside a Conductor:

a) Conductors and Insulators:

When you come in contact with wires in wet condition or while opening the window of your car, you might have experienced a feeling of electric shock. Why don't you get similar experiences with wooden materials?

The reason you get a shock is that there occurs a flow of electrons from one body to another when they come in contact via rubbing or moving against each other. Shock is basically a wild feeling of current passing through your body.

Conductors are materials or substances which allow electricity to flow through them. This is because they contain a large number of free charge carriers (free electrons). In a metal the outer (valence) electrons are loosely bound to the nucleus and are thus free for conductivity, when an external electric field is applied.

Metals, humans, earth and animal bodies are all conductors. The main reason we get electric shocks is that being a good conductor our human body allows a resistance free path for the current to flow from the wire to our body.

Under electrostatic conditions the conductors have following properties.

1. In the interior of a conductor, net electrostatic field is zero.
2. Potential is constant within and on the surface of a conductor.
3. In static situation, the interior of a conductor can have no charge.
4. Electric field just outside a charged conductor is perpendicular to the surface of the conductor at every point.
5. Surface charge density of a conductor could be different at different points.

Electrostatic shielding :

- To protect a delicate instrument from the disturbing effects of other charged bodies near it, place the instrument inside a hollow conductor where $E = 0$. This is called electrostatic shielding.
- Thin metal foils are used in making the shields.
- During lightning and thunder storm it is always advisable to stay inside the car than near a tree in open ground, since the car acts as a shield.

Faraday Cages:

- It is an enclosure which is used to block the external electric fields in conductive materials.
- Electro-magnetic shielding: MRI scanning rooms are built in such a manner that they prevent the mixing of the external radio frequency signals with the MRI machine.

b) Free charges and Bound charges inside materials:

The electrical behaviour of conductors and insulators can be understood on the basis of free and bound charges.

In metallic conductors, the electrons in the outermost shells of the atoms are loosely bound to the nucleus and hence can easily get detached and move freely inside the metal. When an external electric field is applied, they drift in a direction opposite to the direction of the applied electric field. These charges are called free charges.

The nucleus, which consist of the positive ions and the electrons of the inner shells, remain held in their fixed positions. These immobile charges are called bound charges.

In electrolytic conductors, positive and negative ions act as charge carriers but their movements are restricted by the electrostatic force between them and the external electric field.

In insulators, the electrons are tightly bound to the nucleus and are thus not available for conductivity and hence are poor conductors of electricity. There are no free charges since all the charges are bound to the nucleus. An insulating material can be considered as a collection of molecules that are not easily ionized. An insulator can carry any distribution of external electric charges on its surface or in its interior and the electric field in the interior can have non zero values unlike conductors.

8.8 Dielectrics and Electric Polarisation:

Dielectrics are insulates which can be used to store electrical energy. This is because when such substances are placed in an external field, their positive and negative charges get displaced in opposite directions and the molecules develop a net dipole moment. This is called polarization of the material and such materials are called dielectrics.

In every atom there is a positively charged nucleus and there are negatively charged electrons surrounding it. The negative charges form an electron cloud around the positive charge. These two oppositely charged regions have their own centres of charge (where the effective charge is located). The centre of negative charge is the centre of mass of negatively charged electrons and that of positive charge is the centre of mass of positively charged protons in the nucleus.

Thus, dielectrics are insulating materials or non- conducting substances which can be polarised through small localised displacement of charges. e.g. glass, wax, water, wood, mica, rubber, stone, plastic etc.

Dielectrics can be classified as polar dielectrics and non polar dielectrics as described below.

Polar dielectrics:

A molecule in which the centre of mass of positive charges (protons) does not coincide with the centre of mass of negative charges (electrons), because of the asymmetric shape of the molecules is called polar molecule as shown in Fig. 8.18 (a). They have permanent

dipole moments of the order of 10^{-30} Cm. They act as tiny electric dipoles, as the charges are separated by a small distance. The dielectrics like HCl, water, alcohol, NH_3 etc are made of polar molecules and are called polar dielectrics. Water molecule has a bent shape with its two O - H bonds which are inclined at an angle of about 105° . It has a very high dipole moment of 6.1×10^{-30} Cm. Fig. 8.18 (b) and (c) show the structure of HCl and H_2O , respectively.

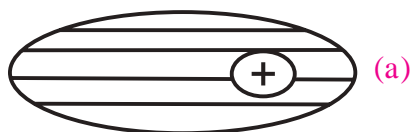

Fig. 8.18. (a) A polar molecule.

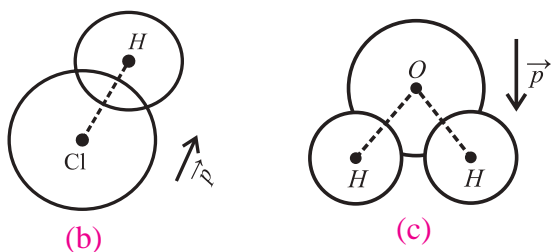

Fig. 8.18. Examples of Polar molecules (b) HCl (c) H_2O .

Non Polar dielectrics:

A molecule in which the centre of mass of the positive charges coincides with the centre of mass of the negative charges is called a non polar molecule as shown in Fig. 8.19 (a). These have symmetrical shapes and have zero dipole moment in the normal state. The dielectrics like hydrogen, nitrogen, oxygen, CO_2 , benzene, methane are made up of nonpolar molecules and are called non polar dielectrics. Structures of H_2 and CO_2 are shown in Fig. 8.19 (b) and (c), respectively.

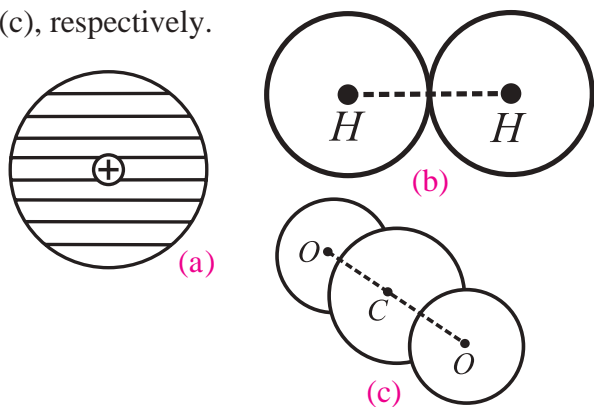

Fig. 8.19. (a) Nonpolar molecule. Examples of Nonpolar molecules (b) H_2 (c) CO_2 .

Polarization of a non-polar dielectric in an external electric field:

In the presence of an external electric field E_o , the centres of the positive charge in each molecule of a non-polar dielectric is pulled in the direction of E_o , while the centres of the negative charges are displaced in the opposite direction. Therefore, the two centres are separated and the molecule gets distorted. The displacement of the charges stops when the force exerted on them by the external field is balanced by the restoring force between the charges in the molecule.

Each molecule becomes a tiny dipole having a dipole moment. The induced dipole moments of different molecules add up giving a net dipole moment to the dielectric in the presence of the external field.

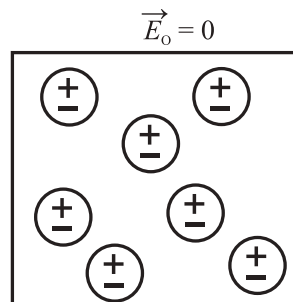

Fig. 8.20 (a) Shows the non polar dielectric in absence of electric field while.

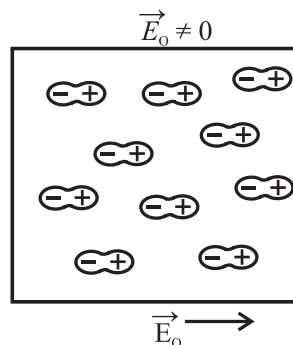

Fig. 8.20 (b) shows it in presence of an external field.

Polarization of a polar dielectric in an external electric field:

The molecules of a polar dielectric have tiny permanent dipole moments. Due to thermal agitation in the material in the absence of any external electric field, these dipole moments are randomly oriented as shown in Fig. 8.21

(a). Hence the total dipole moment is zero. When an external electric field is applied the dipole moments of different molecules tend to align with the field. As a result the dielectric develops a net dipole moment in the direction of the external field. Hence the dielectric is polarized. The extent of polarization depends on the relative values of the two opposing energies.

$$\vec{E}_0 = 0$$

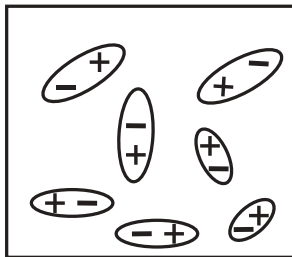
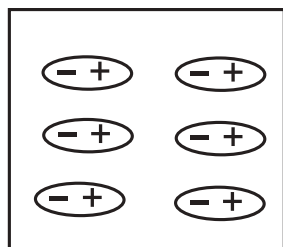

Fig. 8.21 (a) Shows the polar dielectric in absence of electric field while.

$$\vec{E}_0 \neq 0$$



$$\vec{E}_0 \longrightarrow$$

Fig. 8.21 (b) shows it in presence of an external field.

1. The applied external electric field which tends to align the dipole with the field.
2. Thermal energy tending to randomise the alignment of the dipole.

The polarization in presence of a strong external electric field is shown in Fig. 8.21 (b)

Thus, both polar and nonpolar dielectric develop net dipole moment in the presence of an electric field.

The dipole moment per unit volume is called polarization and is denoted by \vec{P} . For linear isotropic dielectrics $\vec{P} = \chi_e \vec{E}$.

χ_e is a constant called electric susceptibility of the dielectric medium. It describes the electrical behaviour of a dielectric. It has different values for different dielectrics.

For vacuum $\chi_e = 0$.

Reduction of electric field due to polarization of a dielectric:

When a dielectric is placed in an external electric field, the value of the field inside the dielectric is less than the external field as a result of polarization. Consider a rectangular dielectric slab placed in a uniform electric field \vec{E} acting parallel to two of its faces. Since the electric charges are not free to move about in a dielectric, no current results when it is placed in an electric field. Instead of moving the charges, the electric field produces a slight rearrangement of charges within the atoms, resulting in aligning them with the field. This is shown in Fig. 8.20 and Fig. 8.21. During the process of alignment charges move only over distances that are less than an atomic diameter.

As a result of the alignment of the dipole moments there is an apparent sheet of positive charges on the right side and negative charges on the left side of the dielectric. These two sheets of induced surface charges produce an electric field \vec{E}_0 called the polarization field in the insulator which opposes the applied electric field \vec{E} . The net field \vec{E}' , inside the dielectric is the vector sum of the applied field \vec{E} and the polarization field \vec{E}_0

$$\therefore E' = E - E_0 \text{ (in magnitude)}$$

This is shown in Fig. 8.22 (a), (b) and (c).

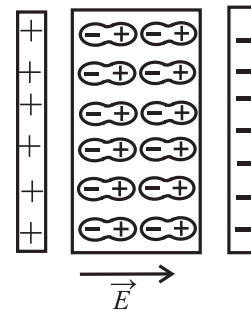

Fig. 8.22 (a) When a dielectric is placed in an external electric field, the dipoles become aligned.

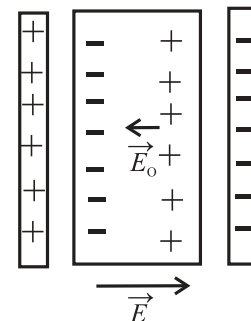

Fig. 8.22 (b) Induced surface charges on the dielectric establish a polarization field \vec{E}_0 in the interior.

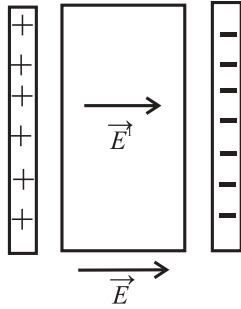

Fig. 8.22 (c) The net field \vec{E} is a vector sum of \vec{E} and \vec{E}_0 .



Do you know?

If we apply a large enough electric field, we can ionize the atoms and create a condition for electric charge to flow like a conductor. The fields required for the breakdown of dielectric is called dielectric strength.

The greater the applied field, greater is the degree of alignment of the dipoles and hence greater is the polarization field.

The induced dipole moment disappears when the field is removed. The induced dipole moment is often responsible for the attraction of a charged object towards an uncharged insulator such as charged comb and bits of paper.

Table 1: Dielectric constants of various materials:

Material	Min	Max
Air	1	1
Ebonite	2.7	2.7
Glass	3.8	14.5
Mica	4	9
Paper	1.5	3
Paraffin	2	3
Porcelain	5	6.5
Quartz	5	5
Rubber	2	4
Wood dry	1.4	2.9
Metals	∞	∞

8.9 Capacitors and Capacitance, Combination of Capacitors in Series and Parallel:

In XIth Std. you have studied about resistors, resistance and conductance. A resistor is an

electrical component which allows current to pass through it and dissipates heat but can't store electrical energy. So there was a need to develop a device that can store electrical energy. The most common arrangement for this consists of a set of conductors (conducting plates) having charges on them and separated by a dielectric material.

The conductors 1 and 2 shown in the Fig. 8.23 have charges $+Q$ and $-Q$ with potential difference, $V = V_1 - V_2$ between them. The electric field in the region between them is proportional to the charge Q .

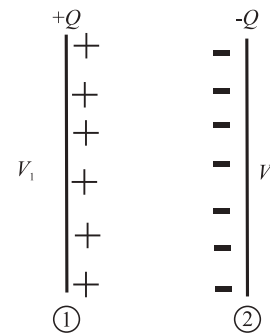

Fig. 8.23: A capacitor formed by two conductors.

The potential difference V is the work done to carry a unit positive test charge from the conductor 2 to conductor 1 against the field. As this work done will be proportional to Q , then $V \propto Q$ and the ratio $\frac{Q}{V}$ is a constant.

$$\therefore C = \frac{Q}{V}$$

The constant C is called the capacitance of the capacitor, which depends on the size, shape and separation of the system of two conductors.

The SI unit of capacitance is farad (F). Dimensional formula is $[M^{-1} L^{-2} T^4 A^2]$.

$$1 \text{ farad} = 1 \text{ coulomb/1 volt}$$

A capacitor has a capacitance of one farad, if the potential difference across it rises by 1 volt when 1 coulomb of charge is given to it. In practice farad is a big unit, the most commonly used units are its submultiples.

$$1\mu\text{F} = 10^{-6}\text{F}$$

$$1\text{nF} = 10^{-9}\text{F}$$

$$1\text{pF} = 10^{-12}\text{F}$$

Uses of Capacitors

Principle of a capacitor:

To understand the principle of a capacitor let us consider a metal plate P_1 having area A . Let some positive charge $+Q$ be given to this plate. Let its potential be V . Its capacity is given by $C_1 = \frac{Q}{V}$

Now consider another insulated metal plate P_2 held near the plate P_1 . By induction a negative charge is produced on the nearer face and an equal positive charge develops on the farther face of P_2 (Fig. 8.24 (a)). The induced negative charge lowers the potential of plate P_1 , while the induced positive charge raises its potential.

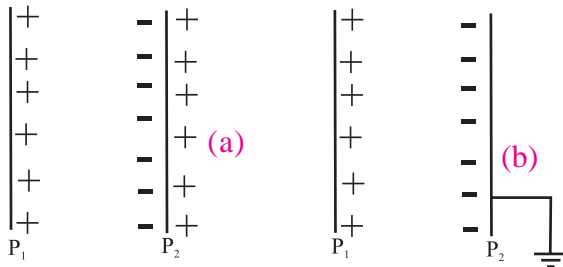

Fig. 8.24: (a) and (b) Parallel plate capacitor.

As the induced negative charge is closer to P_1 it is more effective, and thus there is a net reduction in potential of plate P_1 . If the outer surface of P_2 is connected to earth, the induced positive charges on P_2 being free, flows to earth. The induced negative charge on P_2 stays on it, as it is bound to positive charge of P_1 . This greatly reduces the potential of P_2 , (Fig 8.24 (b)). If V_1 is the potential on plate P_2 due to charge $(-Q)$ then the net potential of the system will now be $+V - V_1$.

Hence the capacity $C_2 = \frac{Q}{V - V_1} \therefore C_2 > C_1$

Thus capacity of metal plate P_1 , is increased by placing an identical earth connected metal plate P_2 near it.

Such an arrangement is called capacitor. It is symbolically shown as $-|+$.

If the conductors are plane then it is called parallel plate capacitor. We also have spherical capacitor, cylindrical capacitor etc.

based on the shape of the conductors.

Combination of Capacitors:

When there is a combination of capacitors to be used in a circuit we can sometimes replace it with an equivalent capacitor or a single capacitor that has the same capacitance as the actual combination of capacitors. The effective capacitance depends on the way the individual capacitors are combined. Here we discuss two basic combinations of capacitors which can be replaced by a single equivalent capacitor.

(a) Capacitors in series:

When a potential difference (V) is applied across several capacitors connected end to end in such a way that sum of the potential difference across all the capacitors is equal to the applied potential difference V , then the capacitors are said to be connected in series.

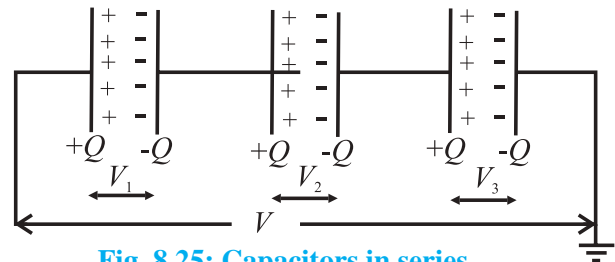

Fig. 8.25: Capacitors in series.

In series arrangement as shown in Fig. 8.25, the second plate of first conductor is connected to the first plate of the second conductor and so on. The last plate is connected to earth. In a series combination, charges on the plates ($\pm Q$) are the same on each capacitor.

Potential difference across the series combination of capacitor is V volt,

$$\text{where } V = V_1 + V_2 + V_3$$

$$\therefore V = \frac{Q}{C_1} + \frac{Q}{C_2} + \frac{Q}{C_3}$$

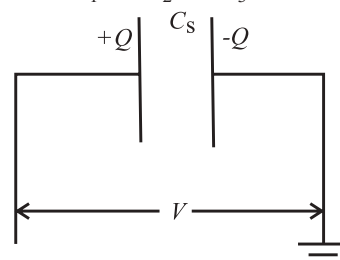

Fig. 8.26: Effective capacitance of three capacitors in series.

Let C_s represent the equivalent capacitance shown in Fig. 8.26, then $V = \frac{Q}{C_s}$

$$\therefore \frac{Q}{C_s} = \frac{Q}{C_1} + \frac{Q}{C_2} + \frac{Q}{C_3}$$

$$\therefore \frac{1}{C_s} = \frac{1}{C_1} + \frac{1}{C_2} + \frac{1}{C_3}$$

(for 3 capacitors in series)

This argument can be extended to yield an equivalent capacitance for n capacitors connected in series which is equal to the sum of the reciprocals of individual capacitances of the capacitors.

$$\therefore \frac{1}{C_{eq}} = \frac{1}{C_1} + \frac{1}{C_2} + \dots + \frac{1}{C_n}$$

If all capacitors are equal then

$$\frac{1}{C_{eq}} = \frac{n}{C} \text{ or } C_{eq} = \frac{C}{n}$$



Remember this

Series combination is used when a high voltage is to be divided on several capacitors. Capacitor with minimum capacitance has the maximum potential difference between the plates.

b) Capacitors in Parallel:

The parallel arrangement of capacitors is as shown in Fig. 8.27 below, where the insulated plates are connected to a common terminal A which is joined to the source of potential, while the other plates are connected to another common terminal B which is earthed.

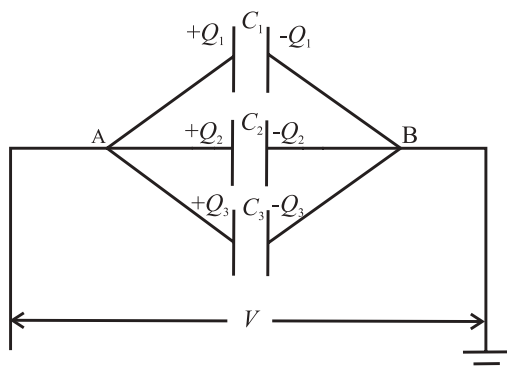

Fig. 8.27: Parallel combination of capacitors.

In this combination all the capacitors have the same potential difference but the plate charges ($\pm Q_1$) on capacitor 1, ($\pm Q_2$) on the capacitor 2 and ($\pm Q_3$) on capacitor 3 are not necessarily the same. If charge Q is applied at point A then it will be distributed to the capacitors depending on the capacitances.

\therefore Total charge Q can be written as $Q = Q_1 + Q_2 + Q_3 = C_1 V + C_2 V + C_3 V$

Let C_p be the equivalent capacitance of the combination then $Q = C_p V$

$$\therefore C_p V = C_1 V + C_2 V + C_3 V$$

$$\therefore C_p = C_1 + C_2 + C_3$$

The general formula for effective capacitance C_p for parallel combination of n capacitors follows similarly

$$C_p = C_1 + C_2 + \dots + C_n$$

If all capacitors are equal then $C_{eq} = nC$



Remember this

Capacitors are combined in parallel when we require a large capacitance at small potentials.

Example 8.15 When 10^8 electrons are transferred from one conductor to another, a potential difference of 10 V appears between the conductors. Find the capacitance of the two conductors.

Solution : Given :

Number of electrons $n = 10^8$

$V = 10$ volt

\therefore charge transferred

$$Q = ne = 10^8 \times 1.6 \times 10^{-19}$$

($\because e = 1.6 \times 10^{-19} \text{ C}$)

$$= 1.6 \times 10^{-11} \text{ C}$$

\therefore Capacitance between two conductors

$$C = \frac{Q}{V} = \frac{1.6 \times 10^{-11}}{10} = 1.6 \times 10^{-10} \text{ F}$$

Example 8.16: From the figure given below find the value of the capacitance C if the equivalent capacitance between A and B is to be $1 \mu\text{F}$. All other capacitors are in micro farad.

Solution : Given :

$C_1 = 8 \mu\text{F}$, $C_2 = 4 \mu\text{F}$, $C_3 = 1 \mu\text{F}$,
 $C_4 = 4 \mu\text{F}$, $C_5 = 4 \mu\text{F}$

The effective capacitance of C_4 and C_5 in parallel
 $= C_4 + C_5 = 4 + 4 = 8 \mu\text{F}$

The effective capacitance of C_3 and $8 \mu\text{F}$ in series
 $= \frac{1 \times 8}{1 + 8} = \frac{8}{9} \mu\text{F}$

The capacitance $8 \mu\text{F}$ is in parallel with the series combination of C_1 and C_2 . Their effective combination is
 $\frac{C_1 C_2}{C_1 + C_2} + \frac{8}{9} \Rightarrow \frac{8 \times 4}{12} + \frac{8}{9} \Rightarrow \frac{32}{9} \mu\text{F}$

This capacitance of $\frac{32}{9} \mu\text{F}$ is in series with C and their effective capacitance is given to be $1 \mu\text{F}$

$$\frac{\frac{32}{9} \times C}{\frac{32}{9} + C} = 1$$

$$\therefore \frac{32}{9} \times C = \frac{32}{9} + C$$

$$= 1.39 \mu\text{F}$$

8.10 Capacitance of a Parallel Plate Capacitor Without and With Dielectric Medium Between the Plates:

In section 8.8 we have studied the behaviour of dielectrics in an external field. Let us now see how the capacitance of a parallel plate capacitor is modified when a dielectric is introduced between its plates.

a) Capacitance of a parallel plate capacitor without a dielectric:

A parallel plate capacitor consists of two thin conducting plates each of area A , held parallel to each other, at a suitable distance d apart. The plates are separated by an insulating medium like paper, air, mica, glass etc. One of the plates is insulated and the other is earthed as shown in Fig. 8.28.

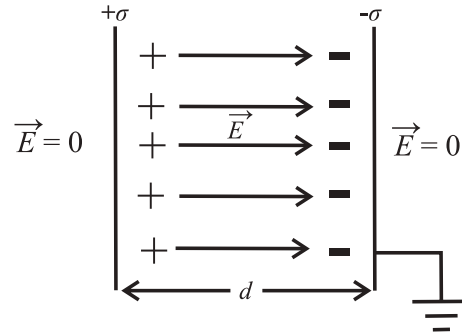

Fig. 8.28: Capacitor with dielectric.

When a charge $+Q$ is given to the insulated plate, then a charge $-Q$ is induced on the inner face of earthed plate and $+Q$ is induced on its farther face. But as this face is earthed the charge $+Q$ being free, flows to earth.

In the outer regions the electric fields due to the two charged plates cancel out. The net field is zero.

$$E = \frac{\sigma}{2\epsilon_0} - \frac{\sigma}{2\epsilon_0} = 0$$

In the inner regions between the two capacitor plates the electric fields due to the two charged plates add up. The net field is thus

$$E = \frac{\sigma}{2\epsilon_0} + \frac{\sigma}{2\epsilon_0} = \frac{\sigma}{\epsilon_0} = \frac{Q}{A\epsilon_0} \quad \text{--- (8.20)}$$

The direction of E is from positive to negative plate.

Let V be the potential difference between the 2 plates. Then electric field between the plates is given by

$$E = \frac{V}{d} \text{ or } V = Ed \quad \text{--- (8.21)}$$

Substituting Eq. (8.20) in Eq. (8.21) we get $V = \frac{Q}{A\epsilon_0} d$

Capacitance of the parallel plate capacitor is given by



Remember this

(1) If there are n parallel plates then there will be $(n-1)$ capacitors, hence

$$C = (n - 1) \frac{A\epsilon_0}{d}$$

(2) For a spherical capacitor, consisting of two concentric spherical conducting shells with inner and outer radii as a and b respectively, the capacitance C is given by

$$C = 4\pi\epsilon_0 \left(\frac{ab}{b - a} \right)$$

(3) For a cylindrical capacitor, consisting of two coaxial cylindrical shells with radii of the inner and outer cylinders as a and b , and length l , the capacitance C is given by

$$C = \frac{2\pi\epsilon_0 l}{\log_e \frac{b}{a}}$$

$$C = \frac{Q}{V} = \frac{Q}{\left(\frac{Qd}{A\epsilon_0} \right)} = \frac{A\epsilon_0}{d} \quad \dots (8.22)$$

b) Capacitance of a parallel plate capacitor with a dielectric slab between the plates:

Let us now see how Eq. (8.22) gets modified with a dielectric slab in between the plates of the capacitor. Consider a parallel plate capacitor with the two plates each of area A separated by a distance d . The capacitance of the capacitor is given by

$$C_0 = \frac{A\epsilon_0}{d}$$

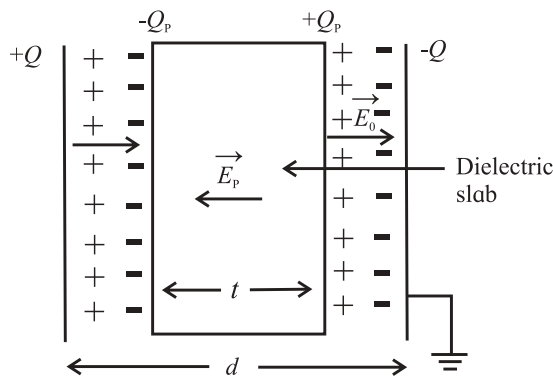

Fig. 8.29: Dielectric slab in the capacitor.

Let E_0 be the electric field intensity between the plates before the introduction of the dielectric slab. Then the potential difference between the plates is given by $V_0 = E_0d$,

$$\text{where } E_0 = \frac{\sigma}{\epsilon_0} = \frac{Q}{A\epsilon_0}, \text{ and}$$

σ is the surface charge density on the plates.

Let a dielectric slab of thickness t ($t < d$) be introduced between the plates of the capacitor. The field E_0 polarizes the dielectric, inducing charge $-Q_p$ on the left side and $+Q_p$ on the right side of the dielectric as shown in Fig. 8.29.

These induced charges set up a field E_p inside the dielectric in the opposite direction of E_0 . The induced field is given by

$$E_p = \frac{\sigma_p}{\epsilon_0} = \frac{Q_p}{A\epsilon_0} \left[\sigma_p = \frac{Q_p}{A} \right]$$

The net field (E) inside the dielectric reduces to $E_0 - E_p$.

Hence,

$$E = E_0 - E_p = \frac{E_0}{k} \left[\because \frac{E_0}{E_0 - E_p} = k \right],$$

where k is a constant called the dielectric constant.

$$\therefore E = \frac{Q}{A\epsilon_0 K} \text{ or } Q = AK\epsilon_0 E \quad \dots (8.23)$$



Remember this

The dielectric constant of a conductor is infinite.

The field E_p exists over a distance t and E_0 over the remaining distance $(d - t)$ between the capacitor plates. Hence the potential difference between the capacitor plates is

$$\begin{aligned} V &= E_0 (d - t) + E(t) \\ &= E_0 (d - t) + \frac{E_0}{k} (t) \quad \left(\because E = \frac{E_0}{k} \right) \\ &= E_0 \left[(d - t) + \frac{t}{k} \right] \\ &= \frac{Q}{A\epsilon_0} \left[d - t + \frac{t}{k} \right] \end{aligned}$$

The capacitance of the capacitor on the introduction of dielectric slab becomes

$$C = \frac{Q}{V} = \frac{Q}{\frac{Q}{A\epsilon_0} \left(d - t + \frac{d}{k} \right)} = \frac{A\epsilon_0}{\left(d - t + \frac{t}{k} \right)}$$

Special cases:

1. If the dielectric fills up the entire space then $t = d \therefore C = \frac{A\epsilon_0 k}{d} = k C_0$

\therefore capacitance of a parallel plate capacitor increases k times i.e. $k = \frac{C}{C_0}$

2. If the capacitor is filled with n dielectric slabs of thickness t_1, t_2, \dots, t_n then this arrangement is equivalent to n capacitors connected in series as shown in Fig. 8.30.

$$\therefore C = \frac{A\epsilon_0}{\left(\frac{t_1}{k_1} + \frac{t_2}{k_2} + \dots + \frac{t_n}{k_n} \right)}$$

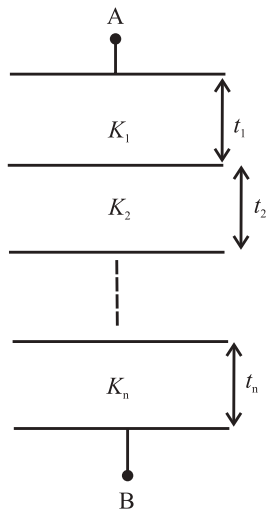

Fig. 8.30 : Capacitor filled with n dielectric slabs.

3. If the arrangement consists of n capacitors in parallel with plate areas A_1, A_2, \dots, A_n and plate separation d

$$C = \frac{\epsilon_0}{d} (A_1 k_1 + A_2 k_2 + \dots + A_n k_n)$$

if $A_1 = A_2 = \dots = A_n = \frac{A}{n}$ then

$$C = \frac{A\epsilon_0}{dn} (k_1 + k_2 + \dots + k_n)$$

4. If the capacitor is filled with a conducting slab ($k = \infty$) then

$$C = \left(\frac{d}{d-t} \right) C_0 \quad \therefore C > C_0$$

The capacitance thus increases by a factor

$$\left(\frac{d}{d-t} \right)$$

8.11 Displacement Current:

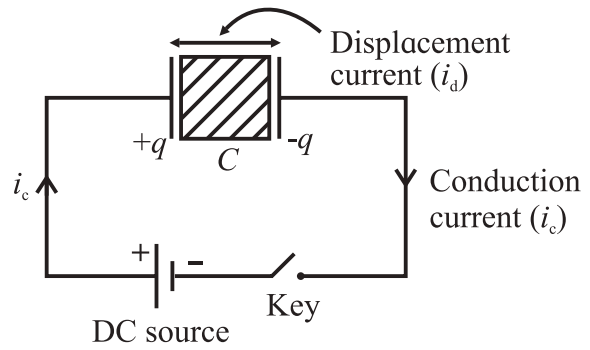

Fig. 8.31: Displacement current in the space between the plates of the capacitor.

We know that electric current in a DC circuit constitutes a flow of free electrons. In a circuit as shown in Fig 8.31, a parallel plate capacitor with a dielectric is connected across a DC source. In the conducting part of the circuit free electrons are responsible for the flow of current. But in the region between the plates of the capacitor, there are no free electrons available for conduction in the dielectric.

As the circuit is closed, the current flows through the circuit and grows to its maximum value (i_c) in a finite time (time constant of the circuit). The conduction current, i_c is found to be same everywhere in the circuit except inside the capacitor. As the current passes through the leads of the capacitor, the electric field between the plates increases and this in turn causes polarisation of the dielectric. Thus, there is a current in the dielectric due to the movement of the bound charges. The current due to bound charges is called displacement current (i_d) or charge-separation current.

We can now derive an expression between i_c and i_d .

From Eq (8.23) we can infer that the charge produced on the plates of a capacitor is due to the electric field E .

$$q = Ak\epsilon_0 E$$

Differentiating the above equation, we get

$$\frac{dq}{dt} = Ak\epsilon_0 \frac{dE}{dt} \quad \text{--- (8.24)}$$

dq/dt is the conduction current (i_c) in the conducting part of the circuit.

$$i_c = \frac{dq}{dt} = Ak\epsilon_0 \frac{dE}{dt}$$

$$\frac{dE}{dt} = \frac{i_c}{Ak\epsilon_0} \therefore \frac{dE}{dt} \propto i_c \text{ (for fixed value of A)}$$

The rate of change of electric field (dE/dt) across the capacitor is directly proportional to the current (i_c) flowing in the conducting part of the circuit.

The quantity on the RHS of Eq (8.24) is having the dimension of electric current and is caused by the displacement of bound charges in the dielectric of the capacitor under the influence of the electric field. This current, called displacement current (i_d), is equivalent to the rate of flow of charge ($dq/dt=i_c$) in the conducting part of the circuit. In the absence of any dielectric between the plates of the capacitor, $k=1$ (for air or vacuum), the displacement current $i_d = A\epsilon_0 (dE/dt)$.

As a broad generalization of displacement current in a circuit containing a capacitor, it can be stated that the displacement currents do not remain confined to the space between the plates of a capacitor. A displacement current (i_d) exists at any point in space where, time-varying electric field (E) exists (i.e. $dE/dt \neq 0$).

Example 8.17 A parallel plate capacitor has an area of 4 cm^2 and a plate separation of 2 mm

- Calculate its capacitance
- What is its capacitance if the space between the plates is filled completely with a dielectric having dielectric constant of constant 6.7.

Solution : Given

$$A = 4 \text{ cm}^2 = 4 \times 10^{-4} \text{ m}^2$$

$$d = 2 \text{ mm} = 2 \times 10^{-3} \text{ m}$$

$$\epsilon_0 = 8.85 \times 10^{-12} \text{ C}^2 / \text{Nm}^2$$

$$\text{(i) Capacitance } C = \frac{A\epsilon_0}{d}$$

$$= \frac{8.85 \times 10^{-12} \times 4 \times 10^{-4}}{2 \times 10^{-3}} = 1.77 \times 10^{-12} \text{ F}$$

$$\text{(ii) Capacitance } C' = \frac{A\epsilon_0 k}{d}$$

$$= \frac{8.85 \times 10^{-12} \times 4 \times 10^{-4} \times 6.7}{2 \times 10^{-3}}$$

$$= 7.90 \times 10^{-12} \text{ F}$$

Example 8.18: In a capacitor of capacitance $20 \mu\text{F}$, the distance between the plates is 2 mm . If a dielectric slab of width 1 mm and dielectric constant 2 is inserted between the plates, what is the new capacitance ?

Solution: Given

$$C = 20 \mu\text{F} = 20 \times 10^{-6} \text{ F}$$

$$d = 2 \text{ mm} = 2 \times 10^{-3} \text{ m}$$

$$t = 1 \times 10^{-3} \text{ m}$$

$$k = 2$$

$$C = \frac{A\epsilon_0}{d} \text{ and } C' = \frac{A\epsilon_0}{d - t + \frac{t}{k}}$$

$$\Rightarrow \frac{C}{C'} = \frac{d - t + \frac{t}{k}}{d}$$

$$\Rightarrow \frac{20}{C'} = \frac{\left(2 \times 10^{-3} - 1 \times 10^{-3} + \frac{1 \times 10^{-3}}{2}\right)}{2 \times 10^{-3}}$$

$$\Rightarrow C' = 26.6 \mu\text{F}$$

8.12 Energy Stored in a Capacitor:

A capacitor is a device used to store energy. Charging a capacitor means transferring electron from one plate of the capacitor to the other. Hence work will have to be done by the battery in order to remove the electrons against the opposing forces. These opposing forces arise since the electrons are being pushed to the negative plate which repels them and electrons are removed from the positive plate which tends to attract them. In both the cases, the forces oppose the transfer from one plate to another. As the charges on the plate increases, opposition also increases.

This work done is stored in the form of electrostatic energy in the electric field between the plates, which can later be recovered by discharging the capacitor.

Consider a capacitor of capacitance C being charged by a DC source of V volts as shown in Fig. 8.32.

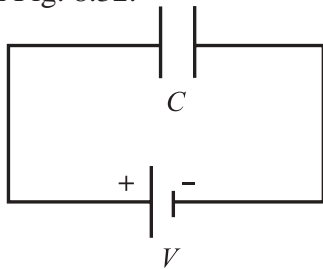

Fig. 8.32: Capacitor charged by a DC source.

During the process of charging, let q' be the charge on the capacitor and V be the potential difference between the plates. Hence

$$C = \frac{q'}{V}$$

A small amount of work is done if a small charge dq is further transferred between the plates.

$$\therefore dW = V dq = \frac{q'}{C} dq$$

Total work done in transferring the charge

$$\begin{aligned} W &= \int dw = \int_0^Q \frac{q'}{C} dq = \frac{1}{C} \int_0^Q q' dq \\ &= \frac{1}{C} \left[\frac{(q')^2}{2} \right]_0^Q = \frac{1}{2} \frac{Q^2}{C} \end{aligned}$$

This work done is stored as electrical potential energy U of the capacitor. This work done can be expressed in different forms as follows.

$$\therefore U = \frac{1}{2} \frac{Q^2}{C} = \frac{1}{2} CV^2 = \frac{1}{2} QV \quad (\because Q = CV)$$



Observe and discuss

The energy supplied to the battery is QV but energy stored in the electric field is $\frac{1}{2} QV$. The rest half $\frac{1}{2} QV$ of energy is wasted as heat in the connecting wires and battery itself.

Example 8.19: A parallel plate air capacitor has a capacitance of 3×10^{-9} Farad. A slab of dielectric constant 3 and thickness 3 cm completely fills the space between the plates.

The potential difference between the plates is maintained constant at 400 volt. What is the change in the energy of capacitor if the slab is removed ?

Solution : Energy stored in the capacitor with air

$$\begin{aligned} E_a &= \frac{1}{2} CV^2 = \frac{1}{2} \times 3 \times 10^{-9} \times (400)^2 \\ &= 24 \times 10^{-5} \text{ J} \end{aligned}$$

when the slab of dielectric constant 3 is introduced between the plates of the capacitor, the capacitance of the capacitor increases to

$$C' = kC$$

$$C' = 3 \times 3 \times 10^{-9} = 9 \times 10^{-9} \text{ F}$$

Energy stored in the capacitor with the dielectric (E_d)

$$E_d = \frac{1}{2} C' V^2$$

$$\begin{aligned} E_d &= \frac{1}{2} \times 9 \times 10^{-9} \times (400)^2 \\ &= 72 \times 10^{-5} \text{ J} \end{aligned}$$

$$\begin{aligned} \text{Change in energy} &= E_d - E_a = (72 - 24) \times 10^{-5} \\ &= 48 \times 10^{-5} \text{ J} \end{aligned}$$

There is, therefore, an increase in the energy on introducing the slab of dielectric material.

8.13 Van de Graaff Generator:

Van de Graaff generator is a device used to develop very high potentials of the order of 10^7 volts. The resulting large electric fields are used to accelerate charged particles (electrons, protons, ions) to high energies needed for experiments to probe the small scale structure of matter and for various experiments in Nuclear Physics.

It was designed by Van de Graaff (1901-1967) in the year 1931.

Principle: This generator is based on

- (i) the phenomenon of Corona Discharge (action of sharp points),
- (ii) the property that charge given to a hollow conductor is transferred to its outer surface and is distributed uniformly over it,
- (iii) if a charge is continuously supplied to an insulated metallic conductor, the potential of the conductor goes on increasing.

Construction:

Fig. 8.33 shows the schematic diagram of Van de Graaff generator.

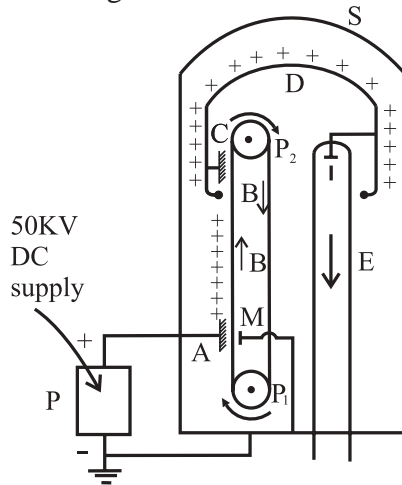

Fig. 8.33: Schematic diagram of van de Graff generator.

- P_1 P_2 = Pulleys
- BB = Conveyer belt
- A = Spray brush
- C = Collector brush
- D = Dome shaped hollow conductor
- E = Evacuated accelerating tube
- I = Ion source
- P = DC power supply
- S = Steel vessel filled with nitrogen
- M = Earthed metal plate

An endless conveyor belt BB made of an insulating material such as reinforced rubber or silk, can move over two pulleys P_1 and P_2 . The belt is kept continuously moving by a motor (not shown in the figure) driving the lower pulley (P_1).

The spray brush A, consisting of a large number of pointed wires, is connected to the positive terminal of a high voltage DC power supply. From this brush positive charge can be sprayed on the belt which can be collected by another similar brush C. This brush is connected to a large, dome-shaped, hollow metallic conductor D, which is mounted on insulating pillars (not shown in the figure). E is an evacuated accelerating tube having an electrode I at its upper end, connected to the dome-shaped conductor.

To prevent the leakage of charge from the dome, the pulley and belt arrangement, the dome and a part of the evacuated tube are enclosed inside a large steel vessel S,

filled with nitrogen at high pressure. A small quantity of Freon gas is mixed with nitrogen to ensure better insulation between the vessel S and its contents. A metal plate M held opposite to the brush A on the other side of the belt is connected to the vessel S, which is earthed.

Working: The electric motor connected to the pulley P_1 is switched on, which begins to rotate setting the conveyor belt into motion. The DC supply is then switched on. From the pointed ends of the spray brush A, positive charge is continuously sprayed on the belt B. The belt carries this charge in the upward direction, which is collected by the collector brush C and sent to the dome shaped conductor.

As the dome is hollow, the charge is distributed over the outer surface of the dome. Its potential rises to a very high value due to the continuous accumulation of charges on it. The potential of the electrode I also rises to this high value.

The positive ions such as protons or deuterons from a small vessel (not shown in the figure) containing ionised hydrogen or deuterium are then introduced in the upper part of the evacuated accelerator tube. These ions, repelled by the electrode I, are accelerated in the downward direction due to the very high fall of potential along the tube, these ions acquire very high energy. These high energy charged particles are then directed so as to strike a desired target.

Uses: The main use of Van de Graff generator is to produce very high energy charged particles having energies of the order of 10 MeV. Such high energy particles are used

1. to carry out the disintegration of nuclei of different elements,
2. to produce radioactive isotopes,
3. to study the nuclear structure,
4. to study different types of nuclear reactions,
5. accelerating electrons to sterilize food and to process materials.

**Internet my friend**

1. <https://en.m.wikipedia.org>
2. hyperphysics.phy-astr.gsu.edu
3. <https://www.britannica.com/science>
4. <https://www.khanacademy.org>in-i>



Exercises

Q1. Choose the correct option

- i) A parallel plate capacitor is charged and then isolated. The effect of increasing the plate separation on charge, potential, capacitance respectively are
 (A) Constant, decreases, decreases
 (B) Increases, decreases, decreases
 (C) Constant, decreases, increases
 (D) Constant, increases, decreases

- ii) A slab of material of dielectric constant k has the same area A as the plates of a parallel plate capacitor and has thickness $(3/4d)$, where d is the separation of the plates. The change in capacitance when the slab is inserted between the plates is

- (A) $C = \frac{A\epsilon_0}{d} \left(\frac{k+3}{4k} \right)$
 (B) $C = \frac{A\epsilon_0}{d} \left(\frac{2k}{k+3} \right)$
 (C) $C = \frac{A\epsilon_0}{d} \left(\frac{k+3}{2k} \right)$
 (D) $C = \frac{A\epsilon_0}{d} \left(\frac{4k}{k+3} \right)$

- iii) Energy stored in a capacitor and dissipated during charging a capacitor bear a ratio.

- (A) 1:1 (B) 1:2
 (C) 2:1 (D) 1:3

- iv) Charge $+q$ and $-q$ are placed at points A and B respectively which are distance $2L$ apart. C is the mid point of A and B. The work done in moving a charge $+Q$ along the semicircle CRD as shown in the figure below is

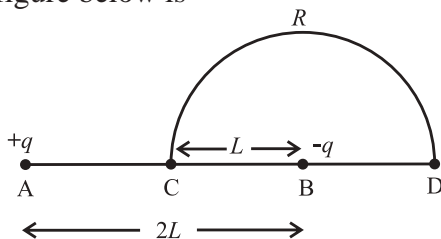

- (A) $\frac{-qQ}{6\pi\epsilon_0 L}$ (B) $\frac{qQ}{2\pi\epsilon_0 L}$

- (C) $\frac{qQ}{6\pi\epsilon_0 L}$ (D) $\frac{-qQ}{4\pi\epsilon_0 L}$

- v) A parallel plate capacitor has circular plates of radius 8 cm and plate separation 1mm. What will be the charge on the plates if a potential difference of 100 V is applied?

- (A) $1.78 \times 10^{-8} \text{ C}$ (B) $1.78 \times 10^{-5} \text{ C}$
 (C) $4.3 \times 10^4 \text{ C}$ (D) $2 \times 10^{-9} \text{ C}$

Q2. Answer in brief.

- i) A charge q is moved from a point A above a dipole of dipole moment p to a point B below the dipole in equatorial plane without acceleration. Find the work done in this process.

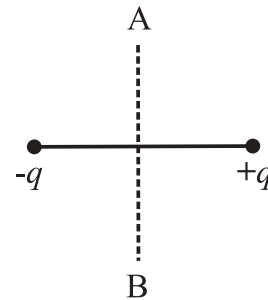

- ii) If the difference between the radii of the two spheres of a spherical capacitor is increased, state whether the capacitance will increase or decrease.

- iii) A metal plate is introduced between the plates of a charged parallel plate capacitor. What is its effect on the capacitance of the capacitor?

- iv) The safest way to protect yourself from lightning is to be inside a car. Justify.

- v) A spherical shell of radius b with charge Q is expanded to a radius a . Find the work done by the electrical forces in the process.

3. A dipole with its charges, $-q$ and $+q$ located at the points $(0, -b, 0)$ and $(0 + b, 0)$ is present in a uniform electric field E . The equipotential surfaces of this field are planes parallel to the YZ planes.

- (a) What is the direction of the electric field E ? (b) How much torque would the dipole experience in this field?
- Three charges $-q$, $+Q$ and $-q$ are placed at equal distance on straight line. If the potential energy of the system of the three charges is zero, then what is the ratio of $Q:q$?
 - A capacitor has some dielectric between its plates and the capacitor is connected to a DC source. The battery is now disconnected and then the dielectric is removed. State whether the capacitance, the energy stored in it, the electric field, charge stored and voltage will increase, decrease or remain constant.
 - Find the ratio of the potential differences that must be applied across the parallel and series combination of two capacitors C_1 and C_2 with their capacitances in the ratio 1:2, so that the energy stored in these two cases becomes the same.
 - Two charges of magnitudes $-4Q$ and $+2Q$ are located at points $(2a, 0)$ and $(5a, 0)$ respectively. What is the electric flux due to these charges through a sphere of radius $4a$ with its centre at the origin?
 - A $6 \mu\text{F}$ capacitor is charged by a 300 V supply. It is then disconnected from the supply and is connected to another uncharged $3\mu\text{F}$ capacitor. How much electrostatic energy of the first capacitor is lost in the form of heat and electromagnetic radiation?
[Ans: $9 \times 10^{-2} \text{ J}$]
 - One hundred twenty five small liquid drops, each carrying a charge of $0.5 \mu\text{C}$ and each of diameter 0.1 m form a bigger drop. Calculate the potential at the surface of the bigger drop.
[Ans: $2.25 \times 10^6 \text{ V}$]
 - The dipole moment of a water molecule is $6.3 \times 10^{-30} \text{ Cm}$. A sample of water contains 10^{21} molecules, whose dipole moments are all oriented in an electric field of strength $2.5 \times 10^5 \text{ N/C}$. Calculate the work to be done to rotate the dipoles from their initial orientation $\theta_1 = 0$ to one

in which all the dipoles are perpendicular to the field, $\theta_2 = 90^\circ$. [Ans: $1.575 \times 10^{-3} \text{ J}$]

- A charge $6 \mu\text{C}$ is placed at the origin and another charge $-5 \mu\text{C}$ is placed on the y axis at a position A $(0, 6.0) \text{ m}$.

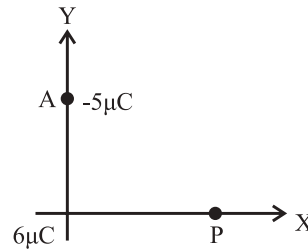

- Calculate the total electric potential at the point P whose coordinates are $(8.0, 0) \text{ m}$
- Calculate the work done to bring a proton from infinity to the point P? What is the significance of the negative sign?

[Ans: (a) $V_p = 2.25 \times 10^3 \text{ V}$

(b) $W = -5.4 \times 10^{-16} \text{ J}$]

- In a parallel plate capacitor with air between the plates, each plate has an area of $6 \times 10^{-3} \text{ m}^2$ and the separation between the plates is 2 mm . a) Calculate the capacitance of the capacitor, b) If this capacitor is connected to 100 V supply, what would be the charge on each plate? c) How would charge on the plates be affected if a 2 mm thick mica sheet of $k = 6$ is inserted between the plates while the voltage supply remains connected?

[Ans: (a) $2.655 \times 10^{-11} \text{ F}$,

(b) $2.655 \times 10^{-9} \text{ C}$, (c) $15.93 \times 10^{-9} \text{ C}$]

- Find the equivalent capacitance between P and Q. Given, area of each plate = A and separation between plates = d .

[Ans: (a) $\frac{2A\epsilon_0}{d}$ (b) $\frac{4A\epsilon_0}{d}$]

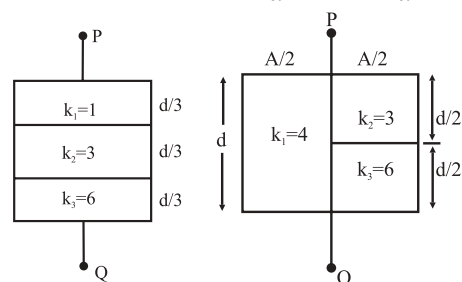

9. Current Electricity



Can you recall?

- There can be three types of electrical conductors: good conductors (metals), semiconductors and bad conductors (insulators).
- Does a semiconductor diode and resistor have similar electrical properties?
- Can you explain why two or more resistors connected in series and parallel have different effective resistances?

9.1 Introduction:

In XIth Std. we have studied the origin of electrical conductivity, in particular for metals. We have also studied how to calculate the effective resistance of two or more resistances in series and in parallel. However, a circuit containing several complex connections of electrical components cannot be easily reduced into a single loop by using the rules of series and parallel combination of resistors. More complex circuits can be analyzed by using Kirchhoff's laws. Gustav Robert Kirchhoff (1824-1887) formulated two rules for analyzing a complicated circuit. In this chapter we will discuss these laws and their applications.

9.2 Kirchhoff's Laws of Electrical Network:

Before describing these laws we will define some terms used for electrical circuits.

Junction: Any point in an electric circuit where two or more conductors are joined together is a junction.

Loop: Any closed conducting path in an electric network is called a loop or mesh.

Branch: A branch is any part of the network that lies between two junctions.

In Fig. 9.1, there are two junctions, labeled a and b. There are three branches: these are the three possible paths 1, 2 and 3 from a to b.

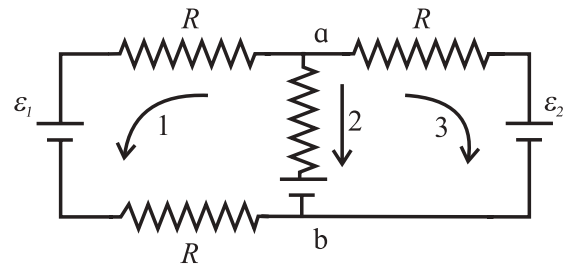

Fig 9.1: Electric network.

For a steady current flowing through an electrical network of resistors, the following Kirchhoff's laws are applicable.

9.2.1 Kirchhoff's First Law: (Current law/ Junction law)

The algebraic sum of the currents at a junction is zero in an electrical network, i.e., $\sum_{i=1}^n I_i = 0$, where I_i is the current in the i^{th} conductor at a junction having n conductors.

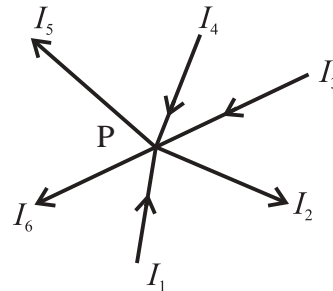

Fig. 9.2: Kirchhoff first law.

Sign convention:

The currents arriving at the junction are considered positive and the currents leaving the junction are considered negative.

Consider a junction P in a circuit where six conductors meet (Fig.9.2). Applying the sign convention, we can write

$$I_1 - I_2 + I_3 + I_4 - I_5 - I_6 = 0 \quad \text{--- (9.1)}$$

Arriving currents I_1 , I_3 and I_4 are considered positive and leaving currents I_2 , I_5 and I_6 are considered negative.

Equation (9.1) can also be written as

$$I_1 + I_3 + I_4 = I_2 + I_5 + I_6$$

Thus the total current flowing towards the junction is equal to the total current flowing away from the junction.

Example 9.1: Figure shows currents in a part of electrical circuit. Find the current X ?

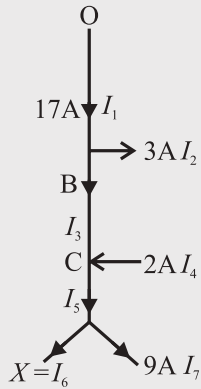

Solutions: At junction B, current I_1 is split into I_2 and I_3 therefore $I_1 = I_2 + I_3$
Substituting values we get $I_3 = 14\text{ A}$
At C, $I_5 = I_3 + I_4$ therefore $I_5 = 16\text{ A}$
At D, $I_5 = I_6 + I_7$ therefore $I_6 = 7\text{ A}$

9.2.2 Kirchhoff's Voltage Law:

The algebraic sum of the potential differences (products of current and resistance) and the electromotive forces (emfs) in a closed loop is zero.

$$\sum IR + \sum \mathcal{E} = 0 \quad \text{--- (9.2)}$$

Sign convention:

1. While tracing a loop through a resistor, if we are travelling along the direction of conventional current, the potential difference across that resistance is considered negative. If the loop is traced against the direction of the conventional current, the potential difference across that resistor is considered positive.
2. The emf of an electrical source is positive while tracing the loop within the source from the negative terminal of the source to its positive terminal. It is taken as negative while tracing within the source from positive terminal to the negative terminal.

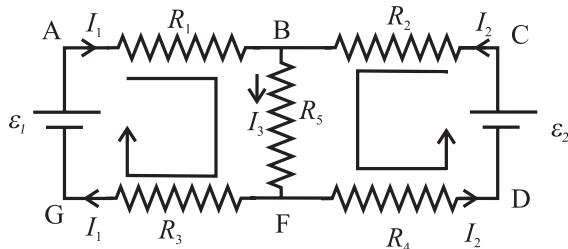

Fig. 9.3: Electrical network.

Consider an electrical network shown in Fig. 9.3.

Consider the loop ABFGA in clockwise

sense. Applying the sign conventions to Eq. (9.2), we get,

$$-I_1R_1 - I_3R_5 - I_1R_3 + \mathcal{E}_1 = 0$$

$$\therefore \mathcal{E}_1 = I_1R_1 + I_3R_5 + I_1R_3$$

Now consider the loop BFDCB in anticlockwise direction. Applying the sign conventions, we get,

$$-I_2R_2 - I_3R_5 - I_2R_4 + \mathcal{E}_2 = 0$$

$$\therefore \mathcal{E}_2 = I_2R_2 + I_3R_5 + I_2R_4$$



Remember this

Kirchhoff's first law is consistent with the conservation of electrical charge while the voltage law is consistent with the law of conservation of energy.

Some charge is received per unit time due to the currents arriving at a junction. For conservation of charge, same amount of charge must leave the junction per unit time which leads to the law of currents.

Algebraic sum of emfs (energy per unit charge) corresponds to the electrical energy supplied by the source. According to the law of conservation of energy, this energy must appear in the form of electrical potential difference across the electrical elements/devices in the loop. This leads to the law of voltages.

Steps usually followed while solving a problem using Kirchhoff's laws:

- i) Choose some direction of the currents.
- ii) Reduce the number of variables using Kirchhoff's first law.
- iii) Determine the number of independent loops.
- iv) Apply voltage law to all the independent loops.
- v) Solve the equations obtained simultaneously.
- vi) In case, the answer of a current variable is negative, the conventional current is flowing in the direction opposite to that chosen by us.

Example 9.2: Two batteries of 7 volt and 13 volt and internal resistances 1 ohm and 2 ohm respectively are connected in parallel with a resistance of 12 ohm. Find the current through each branch of the circuit and the potential difference across 12-ohm resistance.

Solutions: Let the currents passing through the two batteries be I_1 and I_2 .

Applying Kirchhoff second law to the loop AEFBA,

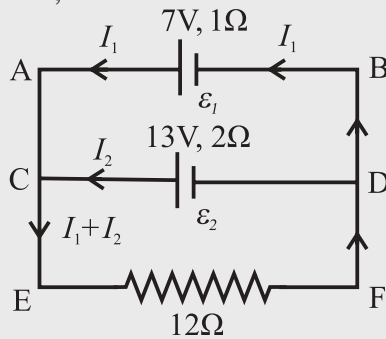

$$-12(I_1 + I_2) - 1I_1 + 7 = 0$$

$$12(I_1 + I_2) + 1I_1 = 7 \quad \text{--- (1)}$$

For the loop CEFDC

$$-12(I_1 + I_2) - 2I_2 + 13 = 0$$

$$12(I_1 + I_2) + 2I_2 = 13 \quad \text{--- (2)}$$

From (1) and (2) $2I_2 - I_1 = 13 - 7 = 6$

$$I_1 = 2I_2 - 6$$

Substituting I_1 value in (2)

$$I_2 = \frac{85}{38} = 2.237 \text{ A}$$

$$I_1 = 2I_2 - 6$$

$$I_1 = 2 \times \frac{85}{38} - 6 = -1.526 \text{ A}$$

$$I = I_1 + I_2 = -1.526 \text{ A} + 2.237 \text{ A} = 0.711 \text{ A}$$

Potential difference across 12 Ω resistance
 $V = IR = 0.711 \times 12 = 8.53 \text{ V}$

Example 9.3: For the given network, find the current through 4 ohm and 3 ohm. Assume that the cells have negligible internal resistance.

Solution: Applying Kirchhoff first law

At junction F,

$$I_1 = I_3 - I_2 \quad I_1 + I_2 = I_3 \quad \text{--- (1)}$$

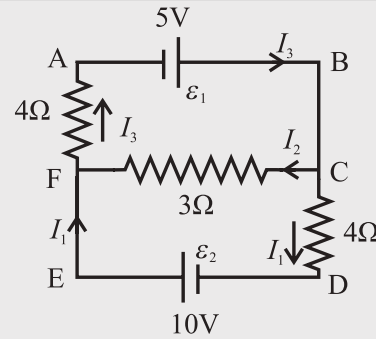

Applying Kirchhoff second law,

(i) loop EFCDE,

$$3I_2 - 4I_1 + 10 = 0$$

$$4I_1 - 3I_2 = 10 \quad \text{--- (2)}$$

(ii) loop FABCF

$$-4I_3 - 3I_2 + 5 = 0$$

$$4I_3 + 3I_2 = 5 \quad \text{--- (3)}$$

From Eq. (1) and Eq. (2)

$$4(I_3 - I_2) - 3I_2 = 10$$

$$-3I_2 + 4I_3 - 4I_2 = 10$$

$$4I_3 - 7I_2 = 10 \quad \text{--- (4)}$$

From Eq. (3) and Eq. (4)

$$10I_2 = -5$$

$$I_2 = -0.5 \text{ A}$$

Negative sign indicates that I_2 current flows from F to C

From Eq. (2) $4I_1 - 3(-0.5) = 10$

$$I_1 = 2.12 \text{ A}$$

$$\therefore I_3 = I_1 + I_2 = 2.12 - 0.5 = 1.62 \text{ A}$$

9.3 Wheatstone Bridge:

Resistance of a material changes due to several factors such as temperature, strain, humidity, displacement, liquid level, etc. Therefore, measurement of these properties is possible by measuring the resistance. Measurable values of resistance vary from a few milliohms to hundreds of mega ohms. Depending upon the resistance range (milliohm to tens of ohm, tens of ohm to hundreds of ohms, hundreds of ohm to mega ohm, etc.), various methods are used for resistance measurement. Wheatstone's bridge is generally used to measure resistances in the range from tens of ohm to hundreds of ohms.

The Wheatstone Bridge was originally developed by Charles Wheatstone (1802- 1875) to measure the values of unknown resistances. It is also used for calibrating measuring instruments, voltmeters, ammeters, etc.

Four resistances P , Q , R and S are connected to form a quadrilateral ABCD as shown in the Fig. 9.4. A battery of emf ε along with a key is connected between the points A and C such that point A is at higher potential with respect to the point C. A galvanometer of internal resistance G is connected between points B and D.

When the key is closed, current I flows through the circuit. It divides into I_1 and I_2 at point A. I_1 is the current through P and I_2 is the current through S . The current I_1 gets divided at point B. Let I_g be the current flowing through the galvanometer. The currents flowing through Q and R are respectively $(I_1 - I_g)$ and $(I_1 + I_g)$,

From the Fig. 9.4,

$$I = I_1 + I_2 \quad \text{--- (9.3)}$$

Consider the loop ABDA. Applying Kirchhoff's voltage law in the clockwise sense shown in the loop we get,

$$-I_1P - I_gG + I_2S = 0 \quad \text{--- (9.4)}$$

Now consider loop BCDB, applying Kirchhoff's voltage law in the clockwise sense shown in the loop we get,

$$-(I_1 - I_g)Q + (I_2 + I_g)R + I_gG = 0 \quad \text{--- (9.5)}$$

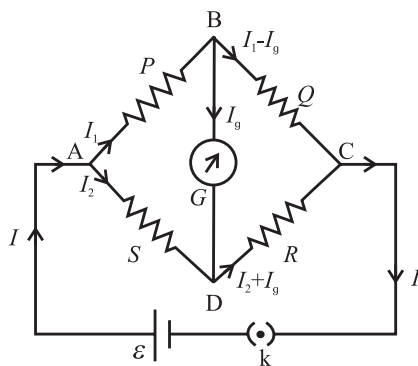

Fig. 9.4 : Wheatstone bridge.

From these three equations (Eq. (9.3), (9.4), (9.5)) we can find the current flowing through any branch of the circuit.

A special case occurs when the current passing through the galvanometer is zero. In this case, the bridge is said to be balanced. Condition for the balance is $I_g = 0$. This condition can be obtained by adjusting the values of P , Q , R and S . Substituting $I_g = 0$ in Eq. (9.4) and Eq. (9.5) we get,

$$-I_1P + I_2S = 0 \therefore I_1P = I_2S \quad \text{--- (9.6)}$$

$$-I_1Q + I_2R = 0 \therefore I_1Q = I_2R \quad \text{--- (9.7)}$$

Dividing Eq. (9.6) by Eq. (9.7), we get

$$\frac{P}{Q} = \frac{S}{R} \quad \text{--- (9.8)}$$

This is the condition for balancing the Wheatstone bridge.

If any three resistances in the bridge are known, the fourth resistance can be determined by using Eq. (9.8).

Example 9.4: At what value should the variable resistor be set such that the bridge is balanced? If the source voltage is 30 V find the value of the output voltage across XY, when the bridge is balanced.

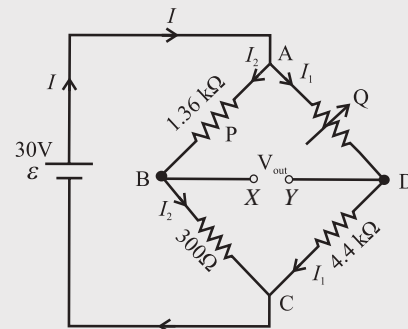

When the bridge is balanced

$$P/Q = R/S$$

$$Q = PS/R$$

$$\frac{1.36 \times 10^3 \times 4.4 \times 10^3}{300} = 19.94 \times 10^3 \Omega$$

Total resistance of the arm

$$ADC = 19940 + 4400 = 24340 \Omega$$

To find output voltage across XY:

Potential difference across

$$AC = I_1 \times 24340 = 30$$

$$I_1 = \frac{30}{24340} A$$

Potential difference across

$$AD = I_1 \times 19940$$

$$= (30 \times 19940) / 24340 = 24.58 \text{ V}$$

$$I_2 = \frac{30}{1360 + 300} = \frac{30}{1660} \text{ A}$$

So, Potential difference across

$$AB = I_2 \times 1360 = \frac{30}{1660} \times 1360 = 24.58 \text{ V}$$

$$V_{out} = V_B - V_D$$

$$= (V_A - V_B) - (V_A - V_D)$$

$$= V_{AB} - V_{AD}$$

$$= 24.58 - 24.58 = 0 \text{ V}$$

Application of Wheatstone bridge:

Figure 9.4 is a basic circuit diagram of Wheatstone bridge, however, in practice the circuit is used in different manner. In all cases it is used to determine some unknown resistance. Few applications of Wheatstone bridge circuits are discussed in the following article.

9.3.1 Metre Bridge:

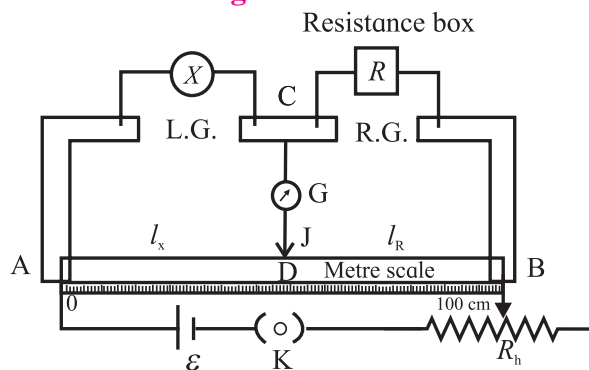

Fig. 9.5: Metre bridge.

Metre bridge (Fig. 9.5) consists of a wire of uniform cross section and one metre in length, stretched on a metre scale which is fixed on a wooden table. The ends of the wire are fixed below two L shaped metallic strips. A single metallic strip separates the two L shaped strips leaving two gaps, left gap and right gap. Usually, an unknown resistance X is connected in the left gap and a resistance box is connected in the other gap. One terminal of a galvanometer is connected to the terminal C on the central strip, while the other terminal of the galvanometer carries the jockey (J).

Temporary contact with the wire AB can be established with the help of the jockey. A cell of emf ϵ along with a key and a rheostat are connected between the points A and B .

A suitable resistance R is selected from resistance box. The jockey is brought in contact with AB at various points on the wire AB and the balance point (null point), D , is obtained. The galvanometer shows no deflection when the jockey is at the balance point.

Let the respective lengths of the wire between A and D , and that between D and C be l_x and l_R . Then using the conditions for the balance, we get

$$\frac{X}{R} = \frac{R_{AD}}{R_{DB}}$$

where R_{AD} and R_{DB} are resistance of the parts AD and DB of the wire resistance of the wire. If l is length of the wire, ρ its specific resistance, and A its area of cross section then

$$R_{AD} = \frac{\rho l_{AD}}{A} \quad R_{DB} = \frac{\rho l_{DB}}{A}$$

$$\frac{X}{R} = \frac{R_{AD}}{R_{DB}} = \frac{\rho l_x / A}{\rho l_R / A}$$

$$\therefore \frac{X}{R} = \frac{l_x}{l_R}$$

Therefore, $X = \frac{l_x}{l_R} R$ --- (9.9)

Knowing R , l_x and l_R , the value of the unknown resistance can be determined.

Example 9.5: Two resistances 2 ohm and 3 ohm are connected across the two gaps of the metre bridge as shown in figure.

Calculate the current through the cell when the bridge is balanced and the specific resistance of the material of the metre bridge wire. Given the resistance of the bridge wire is 1.49 ohm and its diameter is 0.12 cm.

Solution: When the bridge is balanced, the resistances 2 and 3 ohm are in series and the total resistance is 5 ohm.

Let R_1 be the resistance of the wire = 1.49 Ω , and R_2 be the total resistance (2+3)=5 Ω

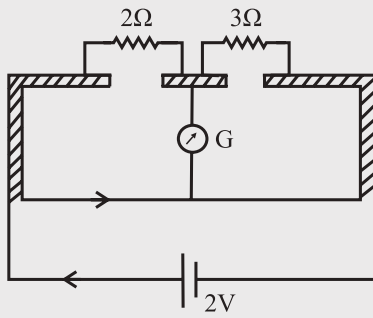

$$R_p = \frac{R_1 R_2}{R_1 + R_2} = \frac{1.49 \times 5}{1.49 + 5} = 1.15 \Omega$$

The current through the cell

$$= \frac{\epsilon}{R_p} = \frac{2}{1.15} = 1.74 \text{ A}$$

Specific resistance of the wire = $\rho = \frac{R\pi r^2}{l}$
 $l = 1 \text{ m}, r = \frac{0.12}{2} = 0.06 \text{ cm}, R = 1.49 \Omega$

$$\rho = \frac{R\pi r^2}{l} = \frac{1.49 \times 3.14 \times (0.06 \times 10^{-2})^2}{1} = 1.68 \times 10^{-6} \Omega \text{ m}$$



Remember this

Source of errors.

1. The cross section of the wire may not be uniform.
2. The ends of the wire are soldered to the metallic strip where contact resistance is developed, which is not taken into account.
3. The measurements of ℓ_x and ℓ_R may not be accurate.

To minimize the errors

- (i) The value of R is so adjusted that the null point is obtained to middle one third of the wire (between 34 cm and 66 cm) so that percentage error in the measurement of ℓ_x and ℓ_R are minimum and nearly the same.
- (ii) The experiment is repeated by interchanging the positions of unknown resistance X and known resistance box R.
- (iii) The jockey should be tapped on the wire and not slid. We use jockey to

detect whether there is a current through the central branch. This is possible only by tapping the jockey.

Applications:

- The Wheatstone bridge is used for measuring the values of very low resistance precisely.
- We can also measure the quantities such as galvanometer resistance, capacitance, inductance and impedance using a Wheatstone bridge.



Do you know?

Wheatstone bridge along with operational amplifier is used to measure the physical parameters like temperature, strain, etc.



Observe and discuss

1. Kelvin's method to determine the resistance of galvanometer (G) by using meter bridge.

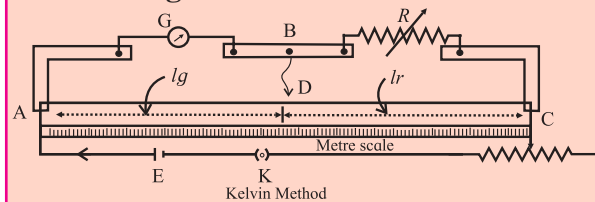

The galvanometer whose resistance (G) is to be determined is connected in one gap and a known resistance (R) in the other gap.

Working :

1. A suitable resistance is taken in the resistance box. The current is sent round the circuit by closing the key. Without touching the jockey at any point of the wire, the deflection in the galvanometer is observed.
2. The rheostat is adjusted to get a suitable deflection Around $(2/3)^{\text{rd}}$ of range.
3. Now, the jockey is tapped at different points of the wire and a point of contact D for which, the galvanometer shows *no change* in the deflection, is found.
4. As the galvanometer shows the same deflection with or without contact

between the point B and D, these two points must be equipotential points.

- The length of the bridge wire between the point D and the left end of the wire is measured. Let l_g be the length of the segment of wire opposite to the galvanometer and l_r be the length of the segment opposite to the resistance box.

Calculation :

Let R_{AD} and R_{DC} be the resistance of the two parts of the wire AD and DC respectively. Since bridge is balanced

$$\frac{G}{R} = \frac{R_{AD}}{R_{DC}}$$

$$\therefore \frac{R_{AD}}{R_{DC}} = \frac{l_g}{l_r} \therefore \frac{G}{R} = \frac{l_g}{l_r}$$

$$\therefore \frac{G}{R} = \frac{l_g}{100 - l_g} \quad \{lg + lr = 100 \text{ cm}\}$$

$$G = \left(\frac{l_g}{100 - l_g} \right) R$$

Using this formula, the unknown resistance of the galvanometer can be calculated.

2. Post Office Box

A post office box (PO Box) is a practical form of Wheatstone bridge as shown in the figure.

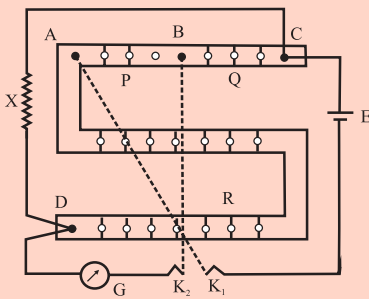

It consists of three arms P, Q and R. The resistances in these three arms are adjustable. The two ratio arms P and Q contain resistances 10 ohm, 100 ohm and 1000 ohm each. The third arm R contains resistances from 1 ohm to 5000 ohm. The unknown resistance X forms the fourth resistance. There are two tap keys K_1 and K_2 .

The resistances in the arms P and Q are fixed to desired ratio. The resistance in the arm R is adjusted so that the galvanometer shows no deflection. Now the bridge is balanced. The unknown resistance $X = RQ / P$, where P and Q are the fixed resistances in the ratio arms and R is an adjustable known resistance.

If L is the length of the wire and r is its radius then the specific resistance of the material of the wire is given by

$$\rho = \frac{X\pi r^2}{L}$$

Do you know?

Wheatstone Bridge for Strain Measurement:

Strain gauges are commonly used for measuring the strain. Their electrical resistance is proportional to the strain in the device. In practice, the range of strain gauge resistance is from 30 ohms to 3000 ohms. For a given strain, the resistance change may be only a fraction of full range. Therefore, to measure small resistance changes with high accuracy, Wheatstone bridge configuration is used. The figure below shows the Wheatstone bridge where the unknown resistor is replaced with a strain gauge as shown in the figure.

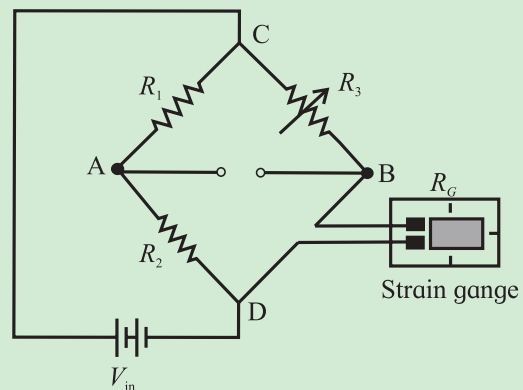

In these circuit, two resistors R_1 and R_2 are equal to each other and R_3 is the variable resistor. With no force applied to the strain gauge, rheostat is varied and

finally positioned such that the voltmeter will indicate zero deflection, i.e., the bridge is balanced. The strain at this condition represents the zero of the gauge.

If the strain gauge is either stretched or compressed, then the resistance changes. This causes unbalancing of the bridge. This produces a voltage indication on voltmeter which corresponds to the strain change. If the strain applied on a strain gauge is more, then the voltage difference across the meter terminals is more. If the strain is zero, then the bridge balances and meter shows zero reading.

This is the application of precise resistance measurement using a Wheatstone bridge.

9.4 Potentiometer:

A voltmeter is a device which is used for measuring potential difference between two points in a circuit. An ideal voltmeter which does not change the potential difference to be measured, should have infinite resistance so that it does not draw any current. Practically, a voltmeter cannot be designed to have an infinite resistance. Potentiometer is one such device which does not draw any current from the circuit. It acts as an ideal voltmeter. It is used for accurate measurement of potential difference.

9.4.1 Potentiometer Principle:

A potentiometer consists of a long wire AB of length L and resistance R having uniform cross sectional area A . (Fig. 9.6) A cell of emf ϵ having internal resistance r is connected across AB as shown in the Fig. 9.6. When the circuit is switched on, current I passes through the wire.

Current through AB, $I = \frac{\epsilon}{R+r}$

Potential difference across AB is

$$V_{AB} = IR$$

$$V_{AB} = \frac{\epsilon R}{(R+r)}$$

Therefore, the potential difference per unit length of the wire is,

$$\frac{V_{AB}}{L} = \frac{\epsilon R}{L(R+r)}$$

As long as ϵ remains constant, $\frac{V_{AB}}{L}$ will remain constant. $\frac{V_{AB}}{L}$ is known as potential gradient along AB and is denoted by K . Potential gradient can be defined as potential difference per unit length of wire.

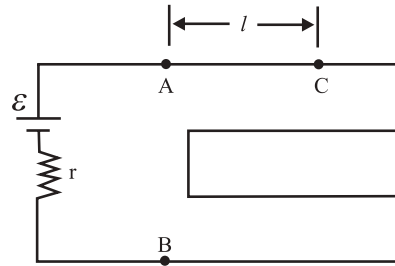

Fig. 9.6: Potentiometer.

Consider a point C on the wire at distance l from the point A, as shown in the figure. The potential difference between A and C is V_{AC} . Therefore,

$$V_{AC} = Kl \text{ i.e. } V_{AC} \propto l$$

Thus, the potential difference between two points on the wire is directly proportional to the length of the wire between them provided the wire is of uniform cross section, the current through the wire is the same and temperature of the wire remains constant. Uses of potentiometer are discussed below.

9.4.2 Use of Potentiometer:

A) To Compare emf. of Cells

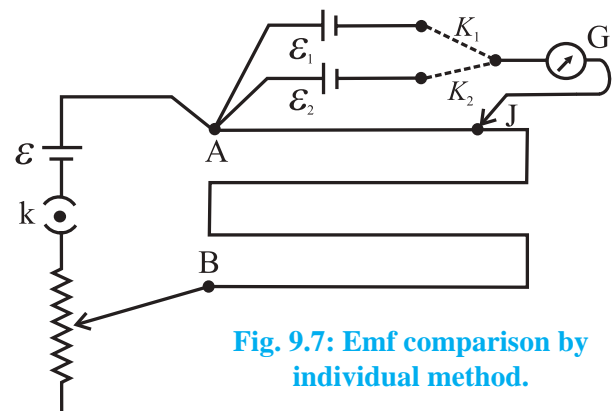

Fig. 9.7: Emf comparison by individual method.

Method I : A potentiometer circuit is set up by connecting a battery of emf ϵ , with a key K and a rheostat such that point A is at higher

potential than point B. The cells whose emfs are to be compared are connected with their positive terminals at point A and negative terminals to the extreme terminals of a two-way key K_1K_2 . The central terminal of the two ways key is connected to a galvanometer. The other end of the galvanometer is connected to a jockey (J). (Fig. 9.7) Key K is closed and then, key K_1 is closed and key K_2 is kept open. Therefore, the cell of emf ϵ_1 comes into circuit. The null point is obtained by touching the jockey at various points on the potentiometer wire AB. Let ℓ_1 be the length of the wire between the null point and the point A. ℓ_1 corresponds to emf ϵ_1 of the cell. Therefore,

$$\epsilon_1 = K \ell_1$$

where K is the potential gradient along the potentiometer wire.

Now key K_1 is kept open and key K_2 is closed. The cell of emf ϵ_2 now comes in the circuit. Again, the null point is obtained with the help of the Jockey. Let ℓ_2 be the length of the wire between the null point and the point A. This length corresponds to the emf ϵ_2 of the cell.

$$\therefore \epsilon_2 = K \ell_2$$

From the above two equations we get

$$\frac{\epsilon_1}{\epsilon_2} = \frac{\ell_1}{\ell_2} \quad \text{--- (9.10)}$$

Thus, we can compare the emfs of the two cells. If any one of the emfs is known, the other can be determined.

Method II: The emfs of cells can be compared also by another method called sum and difference method.

When two cells are connected so that the positive terminal of the first cell is connected to the negative terminal of the second cell as shown in Fig 9.8 (a). The emf of the two cells are added up and the effective emf of the combination of two cells is $\epsilon_1 + \epsilon_2$. This method of connecting two cells is called the sum method.

When two cells are connected so that their negative terminals are together or their positive terminals are connected together as shown in Fig. 9.8 (b).

In this case their emf oppose each other and effective emf of the combination of two cells is $\epsilon_1 - \epsilon_2$ ($\epsilon_1 > \epsilon_2$ assumed). This method of connecting two cells is called the difference method. Remember that this combination of cells is not a parallel combination of cells.

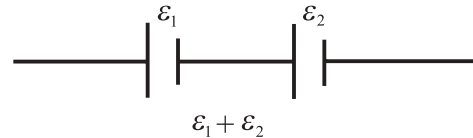

Fig. 9.8 (a): Sum method.

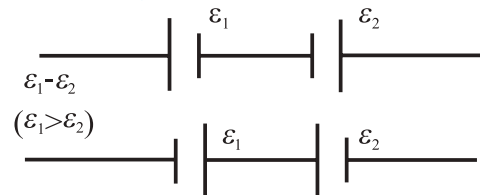

Fig. 9.8 (b): Difference method.

Circuit is connected as shown in Fig.9.9. When keys K_1 and K_3 are closed the cells ϵ_1 and ϵ_2 are in the sum mode. The null point is obtained using the jockey. Let ℓ_1 be the length of the wire between the null point and the point A. This corresponds to the emf ($\epsilon_1 + \epsilon_2$).

$$\therefore \epsilon_1 + \epsilon_2 = k \ell_1$$

Now the key K_1 and K_3 are kept open and keys K_2 and K_4 are closed. In this case the two cells are in the difference mode. Again the null point is obtained. Let ℓ_2 be the length of the wire between the null point and the point A. This corresponds to $\epsilon_1 - \epsilon_2$

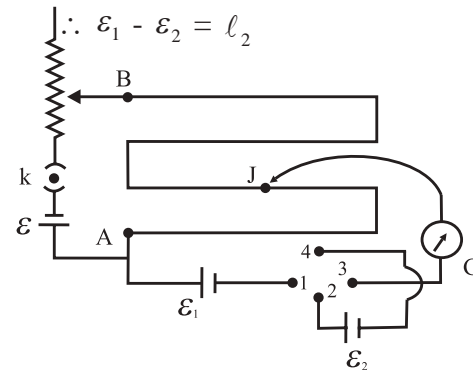

Fig. 9.9: Emf comparison, sum and difference method.

From the above two equations,

$$\frac{\varepsilon_1 + \varepsilon_2}{\varepsilon_1 - \varepsilon_2} = \frac{l_1}{l_2}$$

By componendo and dividendo method, we get,

$$\frac{\varepsilon_1}{\varepsilon_2} = \frac{l_1 + l_2}{l_1 - l_2} \quad \text{--- (9.11)}$$

Thus, emf of two cells can be compared.

B) To Find Internal Resistance (r) of a Cell:

The experimental set up for this method consists of a potentiometer wire AB connected in series with a cell of emf ε , the key K_1 , and rheostat as shown in Fig. 9.10. The terminal A is at higher potential than terminal B. A cell of emf ε_1 whose internal resistance r_1 is to be determined is connected to the potentiometer wire through a galvanometer G and the jockey J. A resistance box R is connected across the cell ε_1 through the key K_2 .

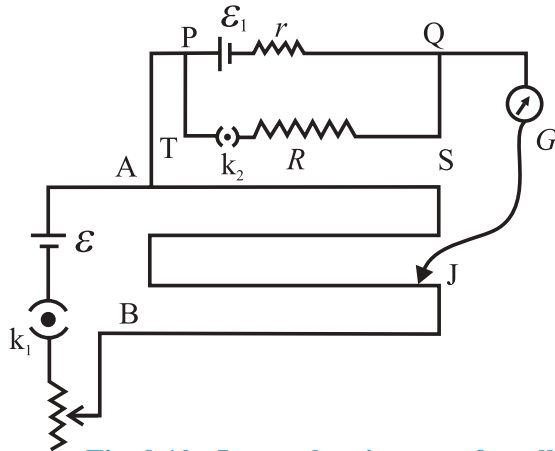

Fig. 9.10 : Internal resistance of a cell.

The key K_1 is closed and K_2 is open. The circuit now consists of the cell ε , cell ε_1 , and the potentiometer wire. The null point is then obtained. Let l_1 be length of the potentiometer wire between the null point and the point A. This length corresponds to emf ε_1 .

$\therefore \varepsilon_1 = k l_1$ where k is potential gradient of the potentiometer wire which is constant.

Now both the keys K_1 and K_2 are closed so that the circuit consists of the cell ε , the cell ε_1 , the resistance box, the galvanometer and the jockey. Some resistance R is selected from the resistance box and null point is obtained.

The length of the wire l_2 between the null point and point A is measured. This corresponds to the voltage between the null point and point A.

$$\therefore V = k l_2 \quad \therefore \frac{\varepsilon_1}{V} = \frac{k l_1}{k l_2} = \frac{l_1}{l_2}$$

Consider the loop PQSTP.

$$\varepsilon_1 = IR + Ir \quad \text{and}$$

$$V = IR$$

$$\therefore \frac{\varepsilon_1}{V} = \frac{IR + Ir}{IR} = \frac{R + r}{R} = \frac{l_1}{l_2}$$

$$\therefore r = R \left(\frac{l_1}{l_2} - 1 \right) \quad \text{--- (9.12)}$$

This equation gives the internal resistance of the cell.

C) Application of potentiometer:

The applications of potentiometer discussed above are used in laboratory. Some practical applications of potentiometer are given below.

1) Voltage Divider: The potentiometer can be used as a voltage divider to continuously change the output voltage of a voltage supply (Fig. 9.11). As shown in the Fig. 9.11, potential V is set up between points A and B of a potentiometer wire. One end of a device is connected to positive point A and the other end is connected to a slider that can move along wire AB. The voltage V divides in proportion of lengths l_1 and l_2 as shown in the figure 9.11.

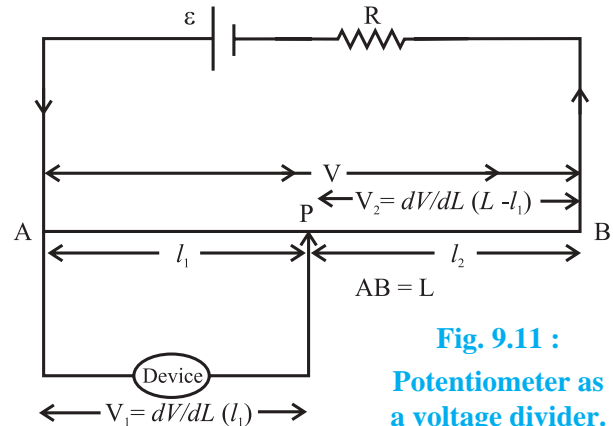

Fig. 9.11 : Potentiometer as a voltage divider.

2) Audio Control: Sliding potentiometers, are commonly used in modern low-power audio systems as audio control devices. Both sliding

(faders) and rotary potentiometers (knobs) are regularly used for frequency attenuation, loudness control and for controlling different characteristics of audio signals.

3) Potentiometer as a sensor: If the slider of a potentiometer is connected to the moving part of a machine, it can work as a motion sensor. A small displacement of the moving part causes changes in potential which is further amplified using an amplifier circuit. The potential difference is calibrated in terms of the displacement of the moving part.

Example 9.7: In an experiment to determine the internal resistance of a cell of emf 1.5 V, the balance point in the open cell condition at is 76.3 cm. When a resistor of 9.5 ohm is used in the external circuit of the cell the balance point shifts to 64.8 cm of the potentiometer wire. Determine the internal resistance of the cell.

Solution: Open cell balancing length $l_1 = 76.3$ cm

Closed circuit balancing length $l_2 = 64.8$ cm External resistance $R = 9.5 \Omega$

$$\begin{aligned} \text{Internal resistance } r &= \left(\frac{l_1 - l_2}{l_2} \right) R \\ &= \left(\frac{76.3 - 64.8}{64.8} \right) \times 9.5 \\ &= 1.686 \Omega \end{aligned}$$

9.4.3 Advantages of a Potentiometer Over a Voltmeter:

Merits:

- Potentiometer is more sensitive than a voltmeter.
- A potentiometer can be used to measure a potential difference as well as an emf of a cell. A voltmeter always measures terminal potential difference, and as it draws some current, it cannot be used to measure an emf of a cell.
- Measurement of potential difference or emf is very accurate in the case of a potentiometer. A very small potential

difference of the order 10^{-6} volt can be measured with it. Least count of a potentiometer is much better compared to that of a voltmeter.

Demerits:

Potentiometer is not portable and direct measurement of potential difference or emf is not possible.

9.5 Galvanometer:

A galvanometer is a device used to detect weak electric currents in a circuit. It has a coil pivoted (or suspended) between concave pole faces of a strong laminated horse shoe magnet. When an electric current passes through the coil, it deflects. The deflection is proportional to the current passing through the coil. The deflection of the coil can be read with the help of a pointer attached to it. Position of the pointer on the scale provided indicates the current passing through the galvanometer or the potential difference across it. Thus, a galvanometer can be used as an ammeter or voltmeter with suitable modification. The galvanometer coil has a moderate resistance (about 100 ohms) and the galvanometer itself has a small current carrying capacity (about 1 mA).

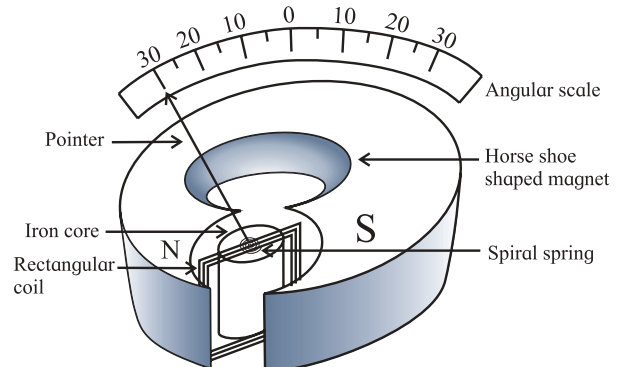

Fig. 9.12 Internal structure of galvanometer.

9.5.1 Galvanometer as an Ammeter:

Let the full scale deflection current and the resistance of the coil G of moving coil galvanometer (MCG) be I_s and G . It can be converted into an ammeter, which is a current measuring instrument. It is always connected in series with a resistance R through which the current is to be measured.

To convert a moving coil galvanometer (MCG) into an ammeter

To convert an MCG into an ammeter, the modifications necessary are

1. Its effective current capacity must be increased to the desired higher value.
2. Its effective resistance must be decreased. The finite resistance G of the galvanometer when connected in series, decreases the current through the resistance R which is actually to be measured. In ideal case, an ammeter should have zero resistance.
3. It must be protected from the possible damages, which are likely due to the passage of an excess electric current to be passed.

In practice this is achieved by connecting a low resistance in parallel with the galvanometer, which effectively reduces the resistance of the galvanometer. This low resistance connected in parallel is called shunt (S). This arrangement is shown in Fig. 9.13.

Uses of the shunt:

- a. It is used to divert a large part of total current by providing an alternate path and thus it protects the instrument from damage.
- b. It increases the range of an ammeter.
- c. It decreases the resistance between the points to which it is connected.

The shunt resistance is calculated as follows. In the arrangement shown in the figure, I_g is the current through the galvanometer.

Therefore, the current through S is $(I - I_g) = I_s$

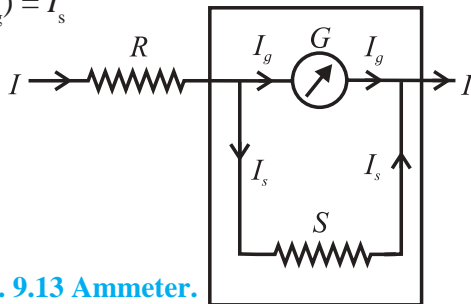

Fig. 9.13 Ammeter.

Since S and G are parallel,

$$\therefore GI_g = SI_s$$

$$\therefore GI_g = S(I - I_g)$$

$$\therefore S = \left(\frac{I_g}{I - I_g} \right) G \quad \text{--- (9.13)}$$

Equation 9.13 is useful to calculate the range of current that the galvanometer can measure.

(i) If the current I is n times current I_g , then $I = n I_g$. Using this in the above expression we get

$$S = \frac{GI_g}{nI_g - I_g} \quad \text{OR} \quad S = \frac{G}{n-1}$$

This is the required shunt to increase the range n times.

(ii) Also if I_s is the current through the shunt resistance, then the remaining current $(I - I_s)$ will flow through galvanometer. Hence

$$\begin{aligned} G(I - I_s) &= S I_s \\ \text{i.e. } GI - G I_s &= S I_s \\ \text{i.e. } S I_s + G I_s &= G I \\ \therefore \frac{I_s}{I} &= \left(\frac{G}{S + G} \right) \end{aligned}$$

This equation gives the fraction of the total current through the shunt resistance.

Example 9.8: A galvanometer has a resistance of 100Ω and its full scale deflection current is $100 \mu A$. What shunt resistance should be added so that the ammeter can have a range of 0 to 10 mA?

Solution: Given $I_G = 100 \mu A = 0.1 \text{ mA}$
The upper limit gives the maximum current to be measured, which is $I = 10 \text{ mA}$.

The galvanometer resistance is $G = 100 \Omega$.
Now

$$n = \frac{10}{0.1} = 100 \therefore s = \frac{G}{n-1} = \frac{100}{100-1} = \frac{100}{99} \Omega$$

Example 9.9: What is the value of the shunt resistance that allows 20% of the main current through a galvanometer of 99Ω ?

Solution: Given
 $G = 99 \Omega$ and $I_G = (20/100)I = 0.2 I$
Now

$$S = \frac{I_G G}{I - I_G} = \frac{0.2 I \times 99}{(I - 0.2 I)} = \frac{0.2 \times 99}{0.8} = 24.75 \Omega$$

9.5.2 Galvanometer as a Voltmeter:

A voltmeter is an instrument used to measure potential difference between two points in an electrical circuit. It is always connected in parallel with the component across which voltage drop is to be measured. A galvanometer can be used for this purpose.

To Convert a Moving Coil Galvanometer into a Voltmeter.

To convert an MCG into a Voltmeter the modifications necessary are:

1. Its voltage measuring capacity must be increased to the desired higher value.
2. Its effective resistance must be increased, and
3. It must be protected from the possible damages, which are likely due to excess applied potential difference.

All these requirements can be fulfilled, if we connect a resistance of suitable high value (X) in series with the given MCG.

A voltmeter is connected across the points where potential difference is to be measured. If a galvanometer is used to measure voltage, it draws some current (due to its low resistance), therefore, actual potential difference to be measured decreases. To avoid this, a voltmeter should have very high resistance. Ideally, it should have infinite resistance.

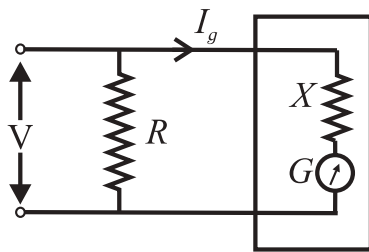

Fig. 9.14 : Voltmeter.

A very high resistance X is connected in series with the galvanometer for this purpose as shown in Fig. 9.14. The value of the resistance X can be calculated as follows.

If V is the voltage to be measured, then

$$V = I_g X + I_g G$$

$$\therefore I_g X = V - I_g G$$

$$\therefore X = \frac{V}{I_g} - G, \quad \text{--- (9.14)}$$

where I_g is the current flowing through the galvanometer.

Eq. (9.14) gives the value of resistance X .

If $n_v = \frac{V}{V_g} = \frac{V}{(I_g \cdot G)}$ is the factor by which the voltage range is increased, it can be shown that $X = G (n_v - 1)$

Example 9.10: A Galvanometer has a resistance of 25Ω and its full scale deflection current is $25 \mu\text{A}$. What resistance should be added to it to have a range of $0 - 10 \text{ V}$?

Solution: Given $G = 25 \mu\text{A}$.

Maximum voltage to be measured is $V = 10 \text{ V}$.

The Galvanometer resistance $G = 25 \Omega$.

The resistance to be added in series,

$$X = \frac{V}{I_G} - G = \frac{10}{25 \times 10^{-6}} - 25$$

$$= 399.975 \times 10^3 \Omega$$

Example 9.11: A Galvanometer has a resistance of 40Ω and a current of 4 mA is needed for a full scale deflection. What is the resistance and how is it to be connected to convert the galvanometer (a) into an ammeter of 0.4 A range and (b) into a voltmeter of 0.5 V range?

Solution: Given $G = 40 \Omega$ and $I_G = 4 \text{ mA}$

(a) To convert the galvanometer into an ammeter of range 0.4 A ,

$$(I - I_G)S = I_G G$$

$$(0.4 - 0.004)S = 0.004 \times 40$$

$$S = \frac{0.004 \times 40}{0.396} = \frac{0.16}{0.396} = 0.4040 \Omega$$

(b) To convert the galvanometer into a voltmeter of range of 0.5 V

$$V = I_G (G + X)$$

$$0.5 = 0.004 (40 + X)$$

$$X = \frac{0.5}{0.004} - 40 = 85 \Omega$$

Comparison of an ammeter and a voltmeter:

AMMETER	VOLTMETER
1. It measures current.	1. It measures potential difference
2. It is connected in series.	2. It is connected in parallel.
3. It is an MCG with low resistance. (Ideally zero)	3. It is an MCG with high resistance. (Ideally infinite)
4. Smaller the shunt, greater will be the current measured.	4. Larger its resistance, greater will be the potential difference measured.
5. Resistance of ammeter is	5. Resistance of voltmeter is
$R_A = \frac{S \cdot G}{S + G} = \frac{G}{n}$	$R_V = G + X = G \cdot n_V$

THERMOELECTRICITY

When electric current is passed through a resistor, electric energy is converted into thermal energy. The reverse process, viz., conversion of thermal energy directly into electric energy was discovered by Seebeck and the effect is called thermoelectric effect.

Seebeck Effect

If two different metals are joined to form a closed circuit (loop) and these junctions are kept at different temperatures, a small emf is produced and a current flows through the metals. This emf is called thermo emf this effect is called the Seebeck effect and the pair of dissimilar metals forming the junction is called a thermocouple. An

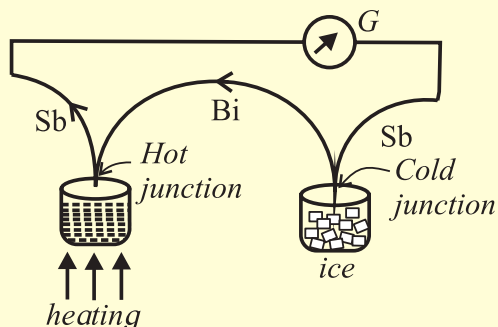

antimony-bismuth thermo-couple is shown in a diagram.

For this thermo couple the current flows from antimony to bismuth at the cold junction. (ABC rule). For a copper-iron

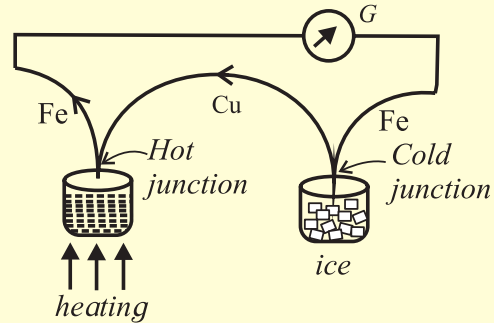

couple (see diagram) the current flows from copper to iron at the hot junction,

This effect is reversible. The direction of the current will be reversed if the hot and cold junctions are interchanged.

The thermo emf developed in a thermocouple when the cold junction is at 0°C and the hot junction is at $T^{\circ}\text{C}$ is given by $\epsilon = \alpha T + \frac{1}{2} \beta T^2$

Here α and β are called the thermoelectric constants. This equation tells that a graph showing the variation of ϵ with temperature is a parabola.

Do you know?

**Accelerator in India:
Cyclotron for medical applications.**



Picture credit: Director, VECC, Kolkata, Department of Atomic Energy, Govt. of India



Exercises

1. Choose the correct option.

- i) Kirchoff's first law, i.e., $\Sigma I = 0$ at a junction, deals with the conservation of
(A) charge (B) energy
(C) momentum (D) mass
- ii) When the balance point is obtained in the potentiometer, a current is drawn from
(A) both the cells and auxiliary battery
(B) cell only
(C) auxiliary battery only
(D) neither cell nor auxiliary battery
- iii) In the following circuit diagram, an infinite series of resistances is shown. Equivalent resistance between points A and B is

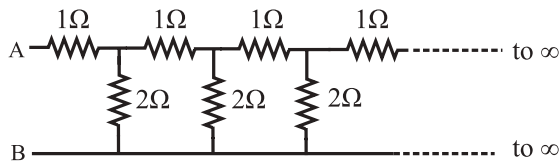

- (A) infinite (B) zero
(C) $2\ \Omega$ (D) $1.5\ \Omega$
- iv) Four resistances $10\ \Omega$, $10\ \Omega$, $10\ \Omega$ and $15\ \Omega$ form a Wheatstone's network. What shunt is required across $15\ \Omega$ resistor to balance the bridge
(A) $10\ \Omega$ (B) $15\ \Omega$
(C) $20\ \Omega$ (D) $30\ \Omega$
- v) A circular loop has a resistance of $40\ \Omega$. Two points P and Q of the loop, which are one quarter of the circumference apart are connected to a $24\ \text{V}$ battery, having an internal resistance of $0.5\ \Omega$. What is the current flowing through the battery.
(A) $0.5\ \text{A}$ (B) $1\ \text{A}$
(C) $2\ \text{A}$ (D) $3\ \text{A}$
- vi) To find the resistance of a gold bangle, two diametrically opposite points of the bangle are connected to the two terminals of the left gap of a metre bridge. A resistance of $4\ \Omega$ is introduced in the right gap. What is the resistance of the bangle if the null point is at $20\ \text{cm}$ from the left end?

- (A) $2\ \Omega$ (B) $4\ \Omega$
(C) $8\ \Omega$ (D) $16\ \Omega$

2. Answer in brief.

- Define or describe a Potentiometer.
 - Define Potential Gradient.
 - Why should not the jockey be slid along the potentiometer wire?
 - Are Kirchoff's laws applicable for both AC and DC currents?
 - In a Wheatstone's meter-bridge experiment, the null point is obtained in middle one third portion of wire. Why is it recommended?
 - State any two sources of errors in meter-bridge experiment. Explain how they can be minimized.
 - What is potential gradient? How is it measured? Explain.
 - On what factors does the potential gradient of the wire depend?
 - Why is potentiometer preferred over a voltmeter for measuring emf?
 - State the uses of a potentiometer.
 - What are the disadvantages of a potentiometer?
 - Distinguish between a potentiometer and a voltmeter.
 - What will be the effect on the position of zero deflection if only the current flowing through the potentiometer wire is (i) increased (ii) decreased.
- Obtain the balancing condition in case of a Wheatstone's network.
 - Explain with neat circuit diagram, how you will determine the unknown resistance by using a meter-bridge.
 - Describe Kelvin's method to determine the resistance of a galvanometer by using a meter bridge.
 - Describe how a potentiometer is used to compare the emfs of two cells by connecting the cells individually.

10. Magnetic Fields due to Electric Current



Can you recall?

- Do you know that a magnetic field is produced around a current carrying wire?
- What is right hand rule?
- Can you suggest an experiment to draw magnetic field lines of the magnetic field around the current carrying wire?
- Do you know solenoid? Can you compare the magnetic field due to a current carrying solenoid with that due to a bar magnet?



Do you know?

You must have noticed high tension power transmission lines, the power lines on the big tall steel towers. Strong magnetic fields are created by these lines. Care has to be taken to reduce the exposure levels to less than 0.5 milligauss (mG).

10.1 Introduction:

In this Chapter you will be studying how magnetic fields are produced by an electric current. Important foundation for further developments will also be laid down.

Hans Christian Oersted first discovered that magnetic field is produced by an electric current passing through a wire. Later, Gauss, Henry, Faraday and others showed that magnetic field is an important partner of electric field. Maxwell's theoretical work highlighted the close relationship of electric and magnetic fields. This resulted into several practical applications in day today life, for example electrical motors, generators, communication systems and computers.

In electrostatics, we have considered static charges and the force exerted by them on other charge or test charge. We now consider forces between charges in motion.



Try this

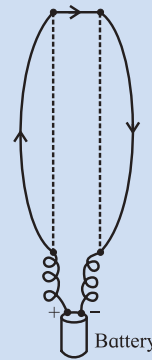

Fig. 10.1 (a)

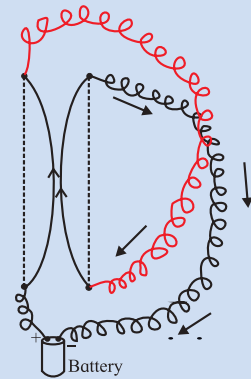

Fig. 10.1 (b)

You can show that wires having currents passing through them, (a) in opposite directions repel and (b) in the same direction attract.

Hang two conducting wires from an insulating support. Connect them to a cell first as shown in Fig. 10.1 (a) and later as shown Fig. 10.1 (b), with the help of binding posts. You will notice that the wires in (a) repel each other and those in (b) come closer, i.e., they attract each other as soon as the current starts. The force in this experiment is certainly not of electrostatic origin, even though the current is due to the electrons flowing in the wires. The overall charge neutrality is maintained throughout the wire, hence the electrostatic forces are ruled out.

You have learnt in Xth Std. that if a magnetic needle is held in close proximity of a current carrying wire, it shows the direction of magnetic field circling around the wire. Imagine that a current carrying wire is grabbed with your right hand with the thumb pointing in the direction of the current, then your fingers curl around in the direction of the magnetic field (Fig. 10.2).

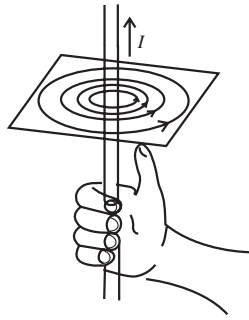

Fig. 10.2: Right hand thumb rule.

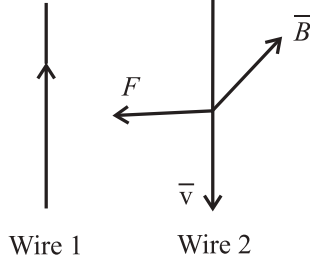

Fig. 10.3: Force on wire 2 due to current in wire 1.

How can one account for the force on the neighbouring current carrying wire? The magnetic field due to current in the wire 1 at any point on wire 2 is directed into the plane of the paper. The electrons flow in a direction opposite to the conventional current. Then the wire 2 experiences a force \vec{F} towards wire 1.

10.2 Magnetic Force:

From the above discussion and Fig. 10.3, you must have realized that the directions of \vec{v} , \vec{B} and \vec{F} follow a vector cross product relationship. Actually the magnetic force F_m on an electron with a charge $-e$, moving with velocity \vec{v} in a magnetic field \vec{B} is

$$\vec{F}_m = -e(\vec{v} \times \vec{B}) \quad \text{--- (10.1)}$$

In general for a charge q , the magnetic force will be

$$\vec{F}_m = q(\vec{v} \times \vec{B}) \quad \text{--- (10.2)}$$

If both electric field \vec{E} and the magnetic field \vec{B} are present, the net force on charge q moving with the velocity \vec{v} in

$$\vec{F} = q[\vec{E} + (\vec{v} \times \vec{B})] \quad \text{--- (10.3)}$$

$$= q\vec{E} + q(\vec{v} \times \vec{B}) = \vec{F}_e + \vec{F}_m \quad \text{--- (10.4)}$$

Justification for this law can be found in experiments such as the one described in Fig. 10.1 (a) and (b). The force described in Fig. (10.4) is known as Lorentz force. Here \vec{F}_e is the force due to electric field and \vec{F}_m is the force due to magnetic field.

There are interesting consequences of the Lorentz force law.

(i) If the velocity \vec{v} of a charged particle is parallel to the magnetic field \vec{B} , the magnetic force is zero.

(ii) If the charge is stationary, $\vec{v} = 0$, the force = 0, even if $\vec{B} \neq 0$.

From Eq. (10.4) it may be observed that the force on the charge due to electric field depends on the strength of the electric field and the magnitude of the charge. However, the magnetic force depends on the velocity of the charge and the cross product of the velocity vector \vec{v} the magnetic field vector \vec{B} , and the charge q .

Consider the vectors \vec{v} and \vec{B} with certain angle between them. Then $\vec{v} \times \vec{B}$ will be a vector perpendicular to the plane containing the vectors \vec{v} and \vec{B} (Fig. 10.4).

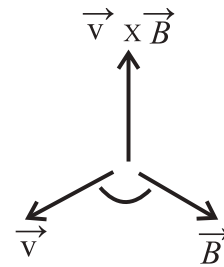

Fig. 10.4: The cross product is in the direction of the unit vector perpendicular to both \vec{v} and \vec{B} .

Thus the vectors \vec{v} and \vec{F} are always perpendicular to each other. Hence, $\vec{F} \cdot \vec{v} = 0$, for any magnetic field \vec{B} . Magnetic force \vec{F}_m is thus perpendicular to the displacement and hence the magnetic force never does any work on moving charges.

The magnetic forces may change the direction of motion of a charged particle but they can never affect the speed.

Interestingly, Eq. (10.2) leads to the definition of units of B . From Eq. (10.2),

$$\vec{F} = q |\vec{v} \times \vec{B}| \hat{n} = qvB \sin \theta \hat{n}, \quad \text{--- (10.5)}$$

where θ is the angle between \vec{v} and \vec{B} and \hat{n} is unit vector in the direction of force.

If the force F is 1 N acting on the charge of 1 C moving with a speed of 1 m s^{-1} perpendicular to \vec{B} , then we can define the unit of B .

$$\therefore B = \frac{F}{qv}$$

$$\therefore \text{unit of } B \text{ is } \frac{\text{N}\cdot\text{s}}{\text{C}\cdot\text{m}}$$

Dimensionally,

$$[B] = [F/qv]$$

This SI unit is called tesla (T)

1 T = 10⁴ gauss. Gauss is not an SI unit, but is used as a convenient unit.



Can you recall?

Electromagnetic crane: How does it work?



Do you know?

Magnetic Resonance Imaging (MRI) technique used for medical imaging requires a magnetic field with a strength of 1.5 T and even upto 7 T. Nuclear Magnetic Resonance experiments require a magnetic field upto 14 T. Such high magnetic fields can be produced using superconducting coil electromagnet. On the other hand, Earth's magnetic field on the surface of the Earth is about 3.6×10^{-5} T = 0.36 gauss.

Example 10.1: A charged particle travels with a velocity \vec{v} through a uniform magnetic field \vec{B} as shown in the following figure, in three different situations. What is the direction of the magnetic force \vec{F}_m due to the magnetic field, on the particle?

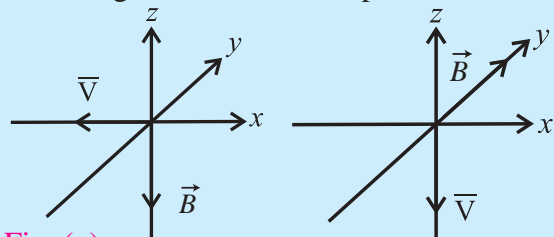

Fig. (a)

Fig. (b)

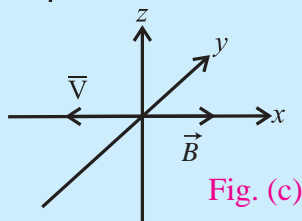

Fig. (c)

Solution: In Fig. (a), the direction of the vector $\vec{v} \times \vec{B}$ will be in the positive y direction. Hence \vec{F}_m will be in the positive y direction. In Fig. (b) $\vec{v} \times \vec{B}$ will be in the positive x direction. Hence the force \vec{F}_m will be in the same direction. In Fig. (c) \vec{v} and \vec{B} are antiparallel, the angle between them is 180° and because $\sin 180^\circ = 0$, \vec{F}_m will be equal to zero.

10.3 Cyclotron Motion:

In a magnetic field, a charged particle typically undergoes circular motion. Figure 10.5 shows a uniform magnetic field directed perpendicularly into the plane of the paper (parallel to the -ve z axis).

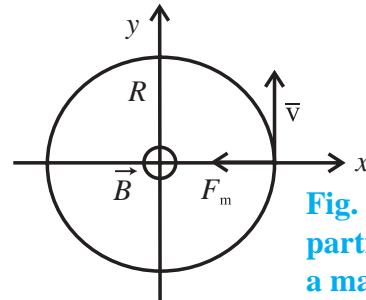

Fig. 10.5: Charged particle moving in a magnetic field.

Figure 10.5 shows a particle with charge q moving with a speed v , and a uniform magnetic field \vec{B} is directed into the plane of the paper. According to the Lorentz force law, the magnetic force on the particle will act towards the centre of a circle of radius R , and this force will provide centripetal force to sustain a uniform circular motion.

Thus

$$qvB = \frac{mv^2}{R} \quad \text{--- (10.6)}$$

$$\therefore mv = p = qBR \quad \text{--- (10.7)}$$

Equation (10.7) represents what is known as cyclotron formula. It describes the circular motion of a charged particle in a particle accelerator, the cyclotron.



Do you know?

Let us look at a charged particle which is moving in a circle with a constant speed. This is uniform circular motion that you have studied earlier. Thus, there must be a net force acting on the particle, directed towards the centre of the circle. As the speed is constant, the force also must be constant, always perpendicular to the velocity of the particle at any given instant of time. Such a force is provided by the uniform magnetic field \vec{B} perpendicular to the plane of the circle along which the charged particle moves.

**Remember this**

Field penetrating into the paper is represented as \otimes , while that coming out of the paper is shown by \odot .

10.3.1 Cyclotron Accelerator:

Particle accelerators have played a key role in providing high energy (MeV to GeV) particle beams useful in studying particle-matter interactions and some of these are also useful in medical treatment of certain tumors/diseases.

The Cyclotron is a charged particle accelerator, accelerating charged particles to high energies. It was invented by Lawrence and Livingston in the year 1934 for the purpose of studying nuclear structure.

Both electric as well as magnetic fields are used in a Cyclotron, in combination. These are applied in directions perpendicular to each other and hence they are called crossed fields. The magnetic field puts the particle (ion) into circular path and a high frequency electric field accelerates it. Frequency of revolution of a charged particle is independent of its energy, in a magnetic field. This fact is used in this machine. Cyclotron consists of two semicircular disc-like metal chambers, D_1 and D_2 , called the dees (Ds). Figure 10.6 shows a schematic diagram of a cyclotron. A uniform magnetic field B is applied perpendicular to plane of the Ds. This magnetic field is produced using an electromagnet producing a field upto $1.5 T$. An alternating voltage upto $10000 V$ at high frequency, 10 MHz (f_a), is applied between the two Ds. Positive ions are produced by a gas ionizing source kept at the point O in between the two Ds. The electric field provides acceleration to the charged particle (ion).

Once the ion is emitted, it accelerates due to the negative voltage of a D and performs a semi circular motion within the D. Whenever the ion moves from one D to the other D, it

accelerates due to the potential difference between the two Ds and again performs semicircular motion in the other D. Thus the ion is acted upon by the electric field every time it moves from one D to the other D. As the electric field is alternating, its sign is changed in accordance with the circular motion of the ion. Hence the ion is always accelerated, its energy increases and the radius of its circular path also increases, making the entire path a spiral (See Fig. 10.6).

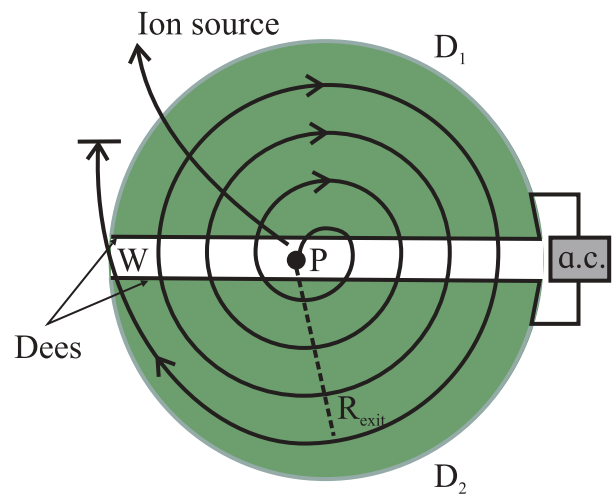

Fig 10.6: Schematic diagram of a Cyclotron with the two Ds. A uniform magnetic field \vec{B} is perpendicular to the plane of the paper, coming out. The ions are injected into the D at point P. An alternating voltage is supplied to the Ds. The entire assembly is placed in a vacuum chamber.

Consider an ion source placed at P. An ion moves in a semi circular path in one of the Ds and reaches the gap between the two Ds in a time interval $T/2$, T being the period of a full revolution. Using the Cyclotron formula Eq. (10.7),

$$mv = qBR,$$

where q is the charge on the ion.

$$\therefore T = \frac{2\pi R}{v} = \frac{m2\pi R}{qBR}$$

$$= \frac{2\pi m}{qB} \quad \text{--- (10.8)}$$

The frequency of revolution (Cyclotron frequency) is

$$f_c = \frac{1}{T} = \frac{qB}{2\pi m} \quad \text{--- (10.9)}$$

The frequency of the applied voltage (f_a) between the two Ds is adjusted so that polarity of the two Ds is reversed as the ion arrives at the gap after completing one semi circle. This condition $f_a = f_c$ is the resonance condition.

The ions do not experience any electric field while they travel within the D. Their kinetic energy increases by eV every time they cross over from one D to the other. Here V is the voltage difference across the gap. The ions move in circular path with successively larger and larger radius to a maximum radius at which they are deflected by a magnetic field so that they can be extracted through an exit slit.

From Eq. (10.7),

$$v = \frac{qBR_{\text{exit}}}{m},$$

where R_{exit} is the radius of the path at the exit.

The kinetic energy of the ions/ protons will be

$$\text{K.E.} = \frac{1}{2} mv^2 = \frac{q^2 B^2 R_{\text{exit}}^2}{2m} \quad \text{--- (10.10)}$$

Thus the final energy is proportional to the square of the radius of the outermost circular path (R_{exit}).

10.4 Helical Motion:

So far it has been assumed that the charged particle moves in a plane perpendicular to magnetic field \vec{B} . If such a particle has some component of velocity parallel to \vec{B} , (\vec{v}_{\parallel}) then it leads to helical motion. Since a component \vec{v}_{\parallel} is parallel to \vec{B} , the magnetic force \vec{F}_m will be:

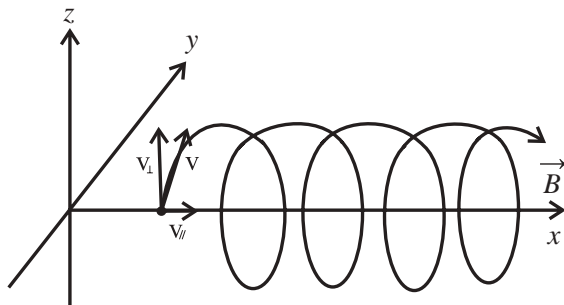

Fig. 10.7: Helical Motion of a charged particle in a magnetic field \vec{B} .

$$\vec{F}_m = \vec{v}_{\parallel} \times \vec{B} = v \cdot B \sin(0^\circ) = 0 \quad \text{--- (10.11)}$$

Thus, \vec{v}_{\parallel} will not be affected and the particle will move along the direction of \vec{B} . At the same time the perpendicular component of the velocity (\vec{v}_{\perp}) leads to circular motion as stated above. As a result, the particle moves parallel to the field \vec{B} while moving along a circular path perpendicular to \vec{B} . Thus the path becomes a helix (Fig. 10.7).



Do you know?

Particle accelerators are important for a variety of research purposes. Large accelerators are used in particle research. There have been several accelerators in India since 1953. The Department of Atomic Energy (DAE), Govt. of India, had taken initiative in setting up accelerators for research. Apart from ion accelerators, the DAE has developed and commissioned a 2 GeV electron accelerator which is a radiation source for research in science. This accelerator, 'Synchrotron', is fully functional at Raja Ramanna Centre for Advanced Technology, Indore. An electron accelerator, Microtron with electron energy 8-10 MeV is functioning at Physics Department, Savitribai Phule Pune University, Pune.



Internet my friend

- (i) Existing and upcoming particle accelerators in India <http://www.researchgate.net>
- (ii) Search the internet for particle accelerators and get more information.

10.5 Magnetic Force on a Wire Carrying a Current:

We have seen earlier the Lorentz force law (Eq. (10.4)). From this equation, we can obtain the force on a current carrying wire.

(i) Straight wire:

Consider a straight wire of length L as shown in Fig. 10.8. An external magnetic field \vec{B} is applied perpendicular to the wire, coming

out of the plane of the paper. Let a current I flow through the wire under an applied potential difference. If \vec{v}_d is the drift velocity of conduction electrons in the part of length L of the wire, the charge q flowing across the plane pp in time t will be

$$q = I t$$

$$q = \frac{IL}{v_d} \quad \text{--- (10.12)}$$

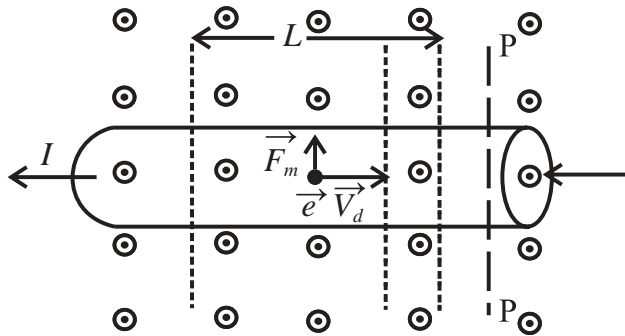

Fig. 10.8 Electrons in the wire having drift velocity \vec{v}_d experience a magnetic force \vec{F}_m upwards as the applied magnetic field lines come out of the plane of the paper.

The magnetic force \vec{F}_m on this charge, according to Eq. (10.2), due to the applied magnetic field \vec{B} is given by

$$\vec{F}_m = q(\vec{v}_d \times \vec{B})$$

$$= \frac{IL}{v_d} B \cdot v_d \sin \theta \hat{n}$$

$$= IL \cdot B \cdot \sin 90^\circ \hat{n} ,$$

where \hat{n} is a unit vector perpendicular to both \vec{B} and \vec{v}_d , in the direction of \vec{F}_m

$$\vec{F}_m = ILB\hat{n} \quad \text{--- (10.13)}$$

This is, therefore, the magnetic force acting on the portion of the straight wire having length L .

If \vec{B} is not perpendicular to the wire, then the above Eq. (10.13) takes the form

$$\vec{F}_m = I\vec{L} \times \vec{B}, \quad \text{--- (10.14)}$$

where \vec{L} is the length vector directed along the portion of the wire of length L .

(ii) Arbitrarily shaped wire:

In the previous section we considered a straight wire. Equation (10.14) can be

extended to a wire of arbitrary shape as shown in Fig. 10.9.

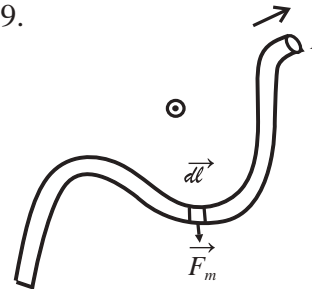

Fig. 10.9: Wire with arbitrary shape.

Consider a segment of infinitesimal length dl along the wire. If I is the current flowing, using Eq. (10.14), the magnetic force due to perpendicular magnetic field \vec{B} (coming out of the plane of the paper) is given by

$$d\vec{F}_m = I d\vec{l} \times \vec{B} \quad \text{--- (10.15)}$$

The force on the total length of wire is

thus
$$\vec{F}_m = \int d\vec{F}_m = I \int d\vec{l} \times \vec{B} \quad \text{--- (10.16)}$$

If \vec{B} is uniform over the whole wire,

$$\vec{F}_m = I \left[\int d\vec{l} \right] \times \vec{B} \quad \text{--- (10.17)}$$

Example 10.2: A particle of charge q follows a trajectory as shown in the figure. Obtain the type of the charge (positive or negatively charged). Obtain the momentum p of the particle in terms of B, L, s, q, s being the distance travelled by the particle.

Particle trajectory: A uniform magnetic field \vec{B} is applied in the region pp , perpendicular to the plane of the paper, coming out of the plane of the paper.

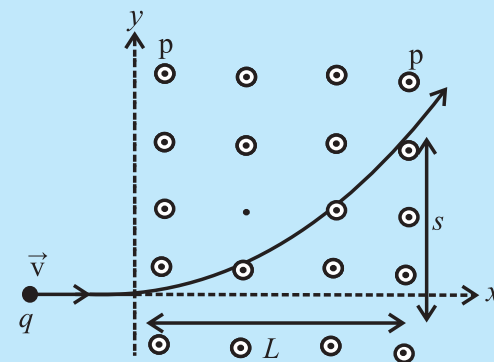

Solution: \vec{B} is coming out of the paper. Since the particle moves upwards, there must be a force in that direction. The velocity is in the positive x direction.

$\therefore \vec{v} \times \vec{B}$ is in -ve y direction. As the force is in + y direction, i.e., opposite, the charge must be negative. According to Eq (10.5), Force = Bqv in the y direction.

$$\therefore \text{acceleration} = \frac{Bqv}{m},$$

where m is the mass of the particle.

Using Newton's equation of motion, the distance travelled in the y direction is given by

$$s = ut + \frac{1}{2} a t^2$$

= $0 + \frac{1}{2} \frac{Bqv}{m} t^2$ as the initial velocity in the y direction is zero. But in the same time t , the particle travels the distance L along the x direction, with uniform velocity \vec{v} .

$$\therefore L = v.t$$

$$\therefore s = \frac{1}{2} \frac{BqL^2}{mv}$$

$$\therefore \text{momentum } p = mv = \frac{1}{2} \frac{Bq}{s} L^2$$

10.6 Force on a Closed Circuit in a Magnetic Field \vec{B} :

Equation (10.17) can be extended to a closed wire circuit C

$$\vec{F}_m = \oint_C I d\vec{l} \times \vec{B} \quad \text{--- (10.18)}$$

Here, the integral is over the closed circuit C.

For uniform \vec{B} ,

$$\vec{F}_m = I \left[\oint_C d\vec{l} \right] \times \vec{B} \quad \text{--- (10.19)}$$

The term in the bracket in Eq. (10.19) is the sum of vectors along a closed circuit. Hence it must be zero.

$$\therefore \vec{F}_m = 0 \quad (\vec{B} \text{ uniform}) \quad \text{--- (10.20)}$$

Example 10.3: Consider a square loop of wire loaded with a glass bulb of mass m hanging vertically, suspended in air with its one part in a uniform magnetic field \vec{B} with its direction coming out of the plane of the paper (\odot). Due to the current I flowing through the loop, there is a magnetic force

in upward direction. Calculate the current I in the loop for which the magnetic force would be exactly balanced by the force on mass m due to gravity.

Solution: The current I in the loop with its part in the magnetic field B causes an upward force F_m in the horizontal part of the loop, given by

$$F_m = IBa,$$

where a is the length of one arm of the loop.

This force is balanced by the force due to gravity.

$$\therefore F_m = IBa = mg$$

$$\therefore I = \frac{mg}{Ba}$$

For this current, the wire loop will hang in air.

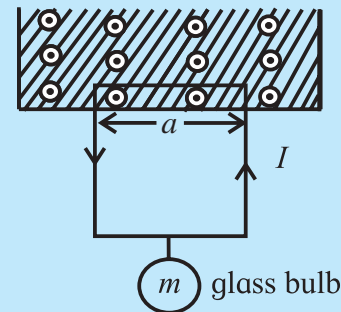

10.7 Torque on a Current Loop:

It will be very interesting to apply the results of the above sections to a current carrying loop of a wire. You have learnt about an electric motor in Xth Std. An electric motor works on the principle you have studied in the preceding sections, i.e., the magnetic force on a current carrying wire due to a magnetic field. Figure 10.10 shows a current carrying loop (abcd) in a uniform magnetic field. There will, therefore, be the magnetic forces \vec{F}_m acting in opposite directions on the segments of the loop ab and cd. This results into rotation of the loop about its central axis.

Without going into the details of contact carbon brushes and external circuit, we can visualize the rotating action of a motor.

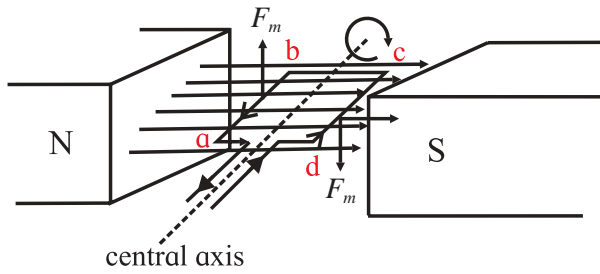

Fig. 10.10: A current loop in a magnetic field: principle of a motor.

The current carrying wire loop is of rectangular shape and is placed in the uniform magnetic field in such a way that the segments *ab* and *cd* of the loop are perpendicular to the field \vec{B} . We can use the right hand rule (Fig. 10.11) to find out the direction of the magnetic force \vec{F}_m . Let the pointing finger of the right hand show the direction of the current, let the middle finger show the direction of the magnetic field \vec{B} , then the stretched thumb shows the direction of the force.

Let us now look at the action of rotation in detail. For this purpose, consider Fig. 10.12 a, showing the rectangular loop *abcd* placed in a uniform magnetic field \vec{B} such that the sides *ab* and *cd* are perpendicular to the magnetic field \vec{B} but the sides *bc* and *da* are not.

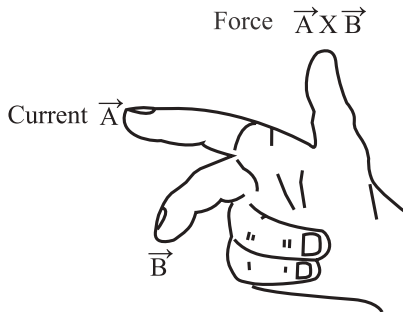

Fig. 10.11: The right hand rule.

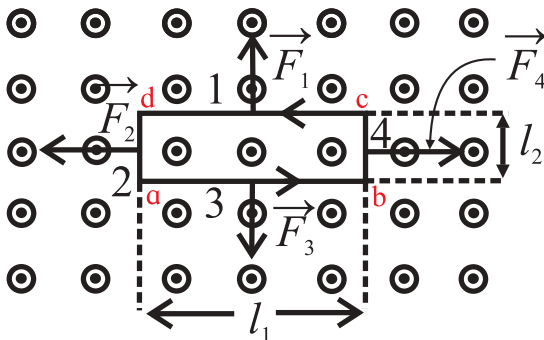

Fig. 10.12 (a): Loop *abcd* placed in a uniform magnetic field emerging out of the paper. Electric connections are not shown.

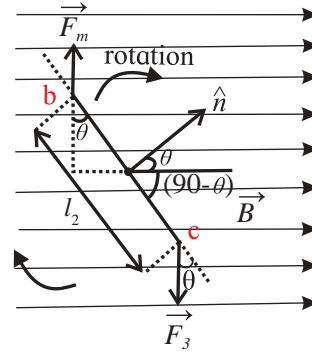

Fig. 10.12 (b): Side view of the loop *abcd* at an angle θ .

Now we can calculate the net force and the net torque on the loop in a situation depicted in Fig. 10.12 (a) and (b). Let us obtain the forces on all sides of the loop. The force \vec{F}_4 on side 4 (*bc*) will be

$$\vec{F}_4 = Il_2 B \sin(90-\theta) \quad \text{--- (10.21)}$$

The force \vec{F}_2 on side 2 (*da*) will be equal and opposite to \vec{F}_4 and both act along the same line. Thus, \vec{F}_2 and \vec{F}_4 will cancel out each other.

The magnitudes of forces \vec{F}_1 and \vec{F}_3 on sides 3 (*ab*) and 1 (*cd*) will be $Il_1 B \sin 90^\circ$ i.e., $Il_1 B$. These two forces do not act along the same line and hence they produce a net torque. This torque results into rotation of the loop so that the loop is perpendicular to the direction of \vec{B} , the magnetic field. The moment arm is $\frac{1}{2}(l_2 \sin \theta)$ about the central axis of the loop. The torque τ due to forces \vec{F}_1 and \vec{F}_3 will then be

$$\begin{aligned} \tau &= (Il_1 B \frac{1}{2} l_2 \sin \theta) + (Il_1 B \frac{1}{2} l_2 \sin \theta) \\ &= Il_1 l_2 B \sin \theta \quad \text{--- (10.22)} \end{aligned}$$

If the current carrying loop is made up of multiple turns *N*, in the form of a flat coil, the total torque will be

$$\begin{aligned} \tau' &= N\tau = N I l_1 l_2 B \sin \theta \\ \tau' &= (NIA)B \sin \theta \quad \text{--- (10.23)} \end{aligned}$$

$$A = l_1 l_2$$

Here *A* is the area enclosed by the coil. The above equation holds good for all flat (planar) coils irrespective of their shape, in a uniform magnetic field.



Can you recall?

How does the coil in a motor rotate by a full rotation? In a motor, we require continuous rotation of the current carrying coil. As the plane of the coil tends to become parallel to the magnetic field \vec{B} , the current in the coil is reversed externally. Referring to Fig. 10.10, the segment ab occupies the position cd . At this position of rotation, the current is reversed. Instead of from b to a , it flows from a to b , force \vec{F}_m continues to act in the same direction so that the torque continues to rotate the coil. The reversal of the current is achieved by using a commutator which connects the wires of the power supply to the coil via carbon brush contacts.

10.7.1 Moving Coil Galvanometer:

A current in a circuit or a voltage of a battery can be measured in terms of a torque exerted by a magnetic field on a current carrying coil. Analog voltmeters and ammeters work on this principle. Figure 10.13 shows a cross sectional diagram of a galvanometer.

It consists of a coil of several turns mounted (suspended or pivoted) in such a way that it can freely rotate about a fixed axis, in a radial uniform magnetic field. A soft iron cylindrical core makes the field radial and strong. The coil rotates due to a torque acting on it as the current flows through it. This torque is given by (Eq. 10.23)

$\tau = N I A B$, where A is the area of the coil, B the strength of the magnetic field, N the number of turns of the coil and I the current in the coil. Here, $\sin \theta = 1$ as the field is radial (plane of the coil will always be parallel to the field). However, this torque is counter balanced by a torque due to a spring fitted as shown in the Fig. 10.13.

This counter torque balances the magnetic torque, so that a fixed steady current I in the coil produces a steady angular deflection ϕ .

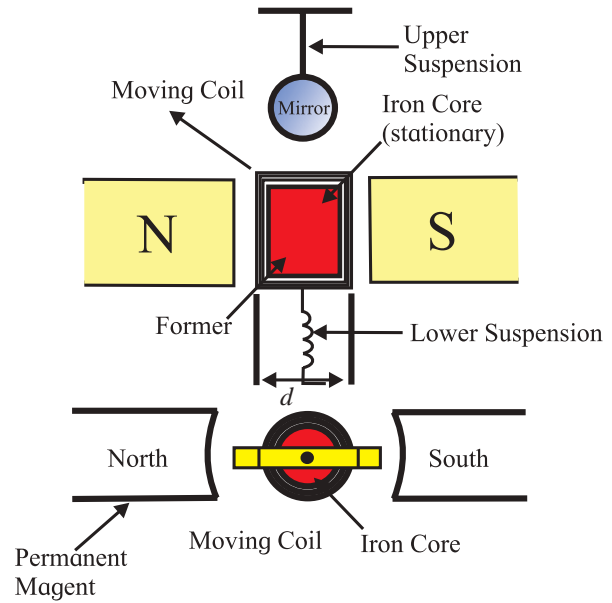

Fig. 10.13: Moving coil galvanometer.

Larger the current is, larger is the deflection and larger is the torque due to the spring. If the deflection is ϕ , the restoring torque due to the spring is equal to $K \phi$ where K is the torsional constant of the spring.

Thus, $K \phi = NIAB$,
and the deflection $\phi = \left(\frac{NAB}{K} \right) I$ --- (10.24)

Thus the deflection ϕ is proportional to the current I . Modern instruments use digital ammeters and voltmeters and do not use such a moving coil galvanometer.

10.8 Magnetic Dipole Moment:

In the preceding section, we have dealt with a current carrying coil. This current carrying coil can be described with a vector $\vec{\mu}$, its magnetic dipole moment. If \hat{n} is a unit vector normal to the plane of the coil, the direction of $\vec{\mu}$ is the direction of \hat{n} shown in Fig. 10.12 (b). We can then define the magnitude of $\vec{\mu}$ as

$\mu = NIA$, --- (10.25)

where N is the number of turns of the coil, I the current passing through the coil, A the area enclosed by each turn of the coil.

If held in uniform magnetic field \vec{B} , the torque responsible for the rotation of the coil, according to Eq. (10.23) will be

$\tau = \mu B \sin \theta$,

θ being an angle between $\vec{\mu}$ (i.e., \hat{n}) and \vec{B} .
 $\therefore \vec{\tau} = \vec{\mu} \times \vec{B}$ --- (10.26)

You have learnt in XIth Std. about the torque on an electric dipole exerted by an electric field, \vec{E} .

$\therefore \vec{\tau} = \vec{P} \times \vec{E}$ --- (10.27)

Here \vec{P} is the electric dipole moment. The two expression Eq. (10.26) and Eq. (10.27) are analogous to each other.

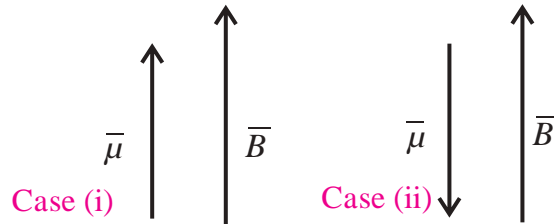

Fig. 10.14: Minimum and maximum magnetic potential energy of a magnetic dipole $\vec{\mu}$ in a magnetic field \vec{B} .

10.9 Magnetic Potential Energy of a Dipole:

A magnetic dipole freely suspended in a magnetic field possesses magnetic potential energy because of its orientation in the field.

You have learnt about an electric dipole in Chapter 8. Electrical Potential energy is associated with an electric dipole on account of its orientation in an electric field. It has been shown that the potential energy U of an electric dipole \vec{P} in an electric field \vec{E} is given by

$U = -\vec{P} \cdot \vec{E}$ --- (10.28)

Analogously, the magnetic potential energy of a magnetic dipole $\vec{\mu}$ in a magnetic field \vec{B} is given by

$U = -\vec{\mu} \cdot \vec{B}$ --- (10.29)

$= -\mu B \cos \theta$, --- (10.30)

where θ is the angle between $\vec{\mu}$ and \vec{B} .

Case (i) : If $\theta = 0$, $U = -\mu B \cos(0^\circ) = -\mu B$

This is the minimum potential energy of a magnetic dipole in a magnetic field i.e., when $\vec{\mu}$ and \vec{B} are parallel to each other.

Case (ii) : If $\theta = 180^\circ$, $U = -\mu B \cos(180^\circ) = \mu B$.

This is the maximum potential energy of a magnetic dipole in a magnetic field, i.e., when $\vec{\mu}$ and \vec{B} are antiparallel to each other.

Example 10.4: A circular coil of conducting wire has 500 turns and an area $1.26 \times 10^{-4} \text{ m}^2$ is enclosed by the coil. A current $100 \mu\text{A}$ is passed through the coil. Calculate the magnetic moment of the coil.

Solution:

$\mu = NIA$
 $= 500 \times 100 \times 10^{-6} \times 1.26 \times 10^{-4} \text{ Am}^2$
 $= 630 \times 10^{-8} = 6.3 \times 10^{-6} \text{ Am}^2 \text{ or J/T.}$

10.10 Magnetic Field due to a Current : Biot-Savart Law:

In sections 10.1 and 10.2, we have seen that magnetic field is produced by a current carrying wire. Can we calculate this magnetic field?

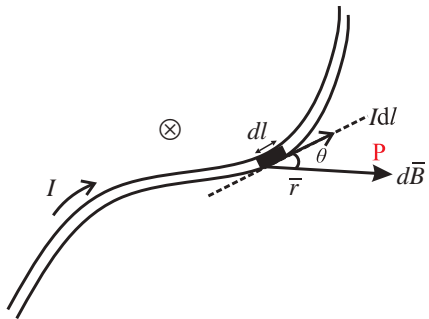

Figure 10.15: A current carrying wire of arbitrary shape, carrying a current I . The current in the differential length element dl produces differential magnetic field $d\vec{B}$ at a point P at a distance \vec{r} from the element dl . The \otimes indicates that $d\vec{B}$ is directed into the plane of the paper.

Figure 10.15 shows an arbitrarily shaped wire carrying a current I . dl is a length element along the wire. The current in this element is in the direction of the length vector \vec{dl} . Let us calculate the differential field $d\vec{B}$ at the point P , produced by the current I through the length element dl . Net magnetic field at the point P can be obtained by superimposition of magnetic fields $d\vec{B}$ at that point due to different length elements along the wire. This can be done by integrating i.e., summing up of magnetic fields $d\vec{B}$ from these length elements. Experimentally, the magnetic fields $d\vec{B}$ produced by current I in the length element $d\vec{l}$ is

$$dB = \frac{\mu_0}{4\pi} \frac{Idl \sin \theta}{r^2} \quad \text{--- (10.31)}$$

Here, θ is the angle between the directions of \vec{dl} and \vec{r} . μ_0 is called permeability constant given by

$$\mu_0 = 4\pi \times 10^{-7} \text{ T. m/A} \quad \text{--- (10.32)}$$

$$\approx 1.26 \times 10^{-6} \text{ T. m/A} \quad \text{--- (10.33)}$$

The direction of $d\vec{B}$ is dictated by the cross product $\vec{dl} \times \vec{r}$. Vectorially,

$$d\vec{B} = \frac{\mu_0}{4\pi} \frac{Id\vec{l} \times \vec{r}}{r^3} \quad \text{--- (10.24)}$$

Equation (10.31) and Eq. (10.34) are known as the Biot and Savart law. This inverse square law is experimentally deduced. It may be noted that this is still inverse **square** law as \vec{r} appears in the numerator and r^3 in the denominator. Using the Biot-Savart law, we can calculate the magnetic field produced by various distributions of currents as discussed below:

(i) Current in a straight, long wire:

You are aware of the right hand thumb rule which gives the direction of the magnetic field produced by a current flowing in a wire. Figure 10.16 shows a long wire of length l . We want to calculate magnetic field \vec{B} at a point P which is at a perpendicular distance R from the wire. Let us consider a current length element (the infinitesimal length $d\vec{l}$ of the wire, multiplied by the current I passing through it) $I \cdot dl$ situated at a distance r from the point P. Using Eq. (10.31), the magnetic field $d\vec{B}$ produced at P due to the current length element $I \cdot d\vec{l}$ becomes

$$d\vec{B} = \frac{\mu_0}{4\pi} \frac{Id\vec{l} \sin \theta}{r^2} \quad \text{--- (10.35)}$$

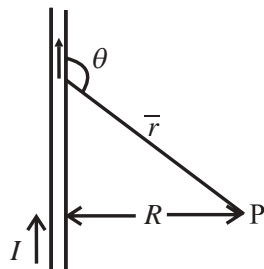

Fig. 10.16: The magnetic field $d\vec{B}$ at P going into the plane of the paper, due to current I through the wire.

Here, the direction of $d\vec{B}$ is given by the cross product $d\vec{l} \times \vec{r}$ (see Eq. (10.34)), hence into the plane of the paper.

- (a) We now calculate the magnitude of the magnetic field produced at P by all current length elements in the upper half of the infinitely long wire. This we do by integrating Eq. (10.35) from 0 to ∞ .
- (b) Let us now calculate the magnitude of the magnetic field produced at P by a current length element in the lower half of the wire. By symmetry, this magnitude is the same as that from the upper half of the wire. The direction of this field is also the same as from the upper half of the wire, going into the plane of the paper.

Adding both the contributions (a) and (b), the total magnetic field B at point P is

$$B = 2 \int_0^\infty dB = 2 \frac{\mu_0}{4\pi} \int_0^\infty \frac{Idl \sin \theta}{r^2} \quad \text{--- (10.36)}$$

But $r = \sqrt{l^2 + R^2}$

and $\sin \theta = \sin(\pi - \theta) = \frac{R}{r} = \frac{R}{\sqrt{l^2 + R^2}} \quad \text{--- (10.37)}$

$$\begin{aligned} \therefore B &= \frac{\mu_0 I}{2\pi} \int_0^\infty \frac{R dl}{(\sqrt{l^2 + R^2})(l^2 + R^2)} \\ &= \frac{\mu_0 I}{2\pi} R \int_0^\infty \frac{dl}{(l^2 + R^2)^{3/2}} \\ \therefore B &= \frac{\mu_0 I}{2\pi} R \frac{1}{R^2} = \frac{\mu_0 I}{2\pi R} \quad \text{--- (10.38)} \end{aligned}$$

From Eq. (10.36), this is the magnetic field at a point P at a perpendicular distance R from the infinitely straight wire. This is due to both the upper semi-infinite part and the lower semi-infinite part of the wire. Thus, the magnetic field B due to semi-infinite straight wire is

$$\therefore B = \frac{\mu_0 I}{4\pi R} \quad \text{--- (10.39)}$$

In Eq. (10.38) and Eq. (10.39), the field is inversely proportional to the distance from the wire.

To solve
$$I = \int_0^{\infty} \frac{dl}{(l^2 + R^2)^{3/2}},$$

we substitute $l = R \tan \theta$; $dl = r \sec^2 \theta \, d\theta$
 Now the limits of the integral also change.

$l = 0, \tan \theta = 0 \therefore \theta = 0$

$l = \infty, \tan \theta = \infty \therefore \theta = \pi/2$

$$\therefore I = \int_0^{\pi/2} \frac{R \sec^2 \theta d\theta}{R^3 (\tan^2 \theta + 1)^{3/2}}$$

$$= \frac{1}{R^2} \int_0^{\pi/2} \frac{(\cos^2 \theta)^{3/2} \sec^2 \theta d\theta}{(\sin^2 \theta + \cos^2 \theta)^{3/2}}$$

$$= \frac{1}{R^2} \int_0^{\pi/2} \cos \theta d\theta$$

$$= \frac{1}{R^2} [\sin \theta]_0^{\pi/2} = \frac{1}{R^2} [1 - 0] = \frac{1}{R^2}$$

10.11 Force of Attraction between two Long Parallel Wires:

As an application of the result obtained in the last section, let us obtain the force of attraction between two long, parallel wires separated by a distance d (Fig. 10.17). Let the currents in the two wires be I_1 and I_2 .

The magnetic field at the second wire due to the current I_1 in the first one, according to Eq. (10.38),

$$B = \frac{\mu_0 I_1}{2\pi d} \quad \text{--- (10.40)}$$

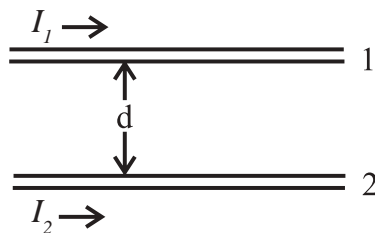

Fig. 10.17 : Two long parallel wires, distance d apart.

By the right hand rule, the direction of this field is into the plane of the paper. We now apply the Lorentz Force law. Accordingly, the force on the wire 2, because of the current I_2 and the magnetic field B due to current in wire 1, is given by (Eq. 10.13).

$$F = I_2 \left(\frac{\mu_0 I_1}{2\pi d} \right) \int dl \quad \text{--- (10.41)}$$

The direction of this force is towards wire 1, i.e., it will be attractive force.

For infinitely long wires, this force will be infinite!

Force per unit length of the wire will be

$$F' = \frac{\mu_0}{2\pi} \frac{I_1 I_2}{d} \quad \text{--- (10.42)}$$

If the currents I_1 and I_2 are antiparallel, the force will be repulsive.

Let us consider a section of length L of the wire 2. The force on this section due to the current in wire 1 is given by

$$F = I_2 B L \quad \text{--- (10.43)}$$

$$= \frac{\mu_0 I_1 I_2}{2\pi d} L = F_{21} \quad \text{--- (10.44)}$$

We will denote this force by F_{21} i.e., the force on a section of length L of wire 2 due to the current in wire 1. Similarly, the force on a section of the same length L of wire 1 will experience a force due to the current in wire 2.

This force we denote as F_{12} , which is equal and opposite to F_{21}

$$\therefore F_{21} = - F_{12} \quad \text{--- (10.44 A)}$$

The force of attraction per unit length is then, from Eq. (10.44),

$$\frac{F}{L} = \frac{\mu_0}{2\pi} \frac{I_1 I_2}{d} \quad \text{--- (10.45)}$$

If the currents I_1 and I_2 are flowing in opposite directions, then there is a force of repulsion on the sector of length L of each of the wires. The magnitude of the repulsive force per unit length of the wire is also given by

$$\frac{F}{L} = \frac{\mu_0}{2\pi} \frac{I_1 I_2}{d} \quad \text{--- (10.46)}$$

We can summarize these result as: **Parallel currents attract, antiparallel currents repel.**

The ampere: Definition of the unit of electrical current ampere, was adopted a few decades ago. Consider two parallel conducting wires having infinite length, have a separation of 1 m, and are placed in vacuum. The constant current through these wires producing a force on each other of magnitude 2×10^{-7} N per meter of their length, is 1 ampere (A).

It is a straight forward evaluation from Eq. (10.45).

$$\frac{F}{L} = \frac{\mu_0}{2\pi} \frac{I_1 I_2}{d}$$

$$\frac{\mu_0}{4\pi} = 10^{-7} \text{ Wb/m; } d = 1 \text{ m}$$

$$\text{For } I_1 = I_2 = 1\text{A, } \frac{F}{L} = 2 \times 10^{-7} \text{ N per meter.}$$

Here it is assumed that the wire diameter is very much less than 1 m.

10.12 Magnetic Field Produced by a Current in a Circular Arc of a Wire:

After considering straight parallel wires let us obtain the magnetic field at a point produced by a current in a circular arc of a wire. Figure 10.18 depicts a circular arc of a wire (AB), carrying a current I . We can first obtain the magnetic field produced by one current-length element of the arc and then integrate over the entire arc length. The circular arc AB subtends an angle θ at the centre O of the circle of which the arc is a part, and r is its radius. Using Biot-Savart law Eq. (10.34), the magnetic field produced at O is:

$$\begin{aligned} d\vec{B} &= \frac{\mu_0}{4\pi} \frac{I \cdot d\vec{l} \times \vec{r}}{r^3} \\ dB &= \frac{\mu_0}{4\pi} I \cdot \frac{dl \cdot r \cdot \sin 90^\circ}{r^3} \\ &= \frac{\mu_0}{4\pi} \frac{Idl}{r^2} \end{aligned} \quad \text{--- (10.47)}$$

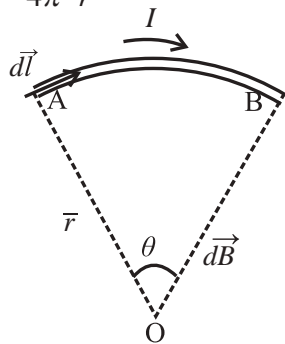

Fig. 10.18 : Current carrying wire of a shape of circular arc. The length element $d\vec{l}$ is always perpendicular to \vec{r} .

Equation (10.47) gives the magnitude of the field. The direction of the field is given by the right hand rule. Aligning the thumb in the direction of the current, the field direction

is indicated by the curling fingers. Thus, the direction of each of the dB is into the plane of the paper. The total field at O is therefore,

$$\begin{aligned} B &= \int dB = \frac{\mu_0}{4\pi} I \int_A^B \frac{dl}{r^2} \\ &= \frac{\mu_0}{4\pi} I \int_0^\theta \frac{r}{r^2} d\theta = \frac{\mu_0}{4\pi} \frac{I}{r} \theta, \end{aligned} \quad \text{--- (10.48)}$$

where the angle θ is in radians.

Magnetic field at the centre of a full circle of a wire, carrying a current I :

For a full circular wire carrying a current I , the magnetic field at the centre of the circle, using Eq. (10.48),

$$\begin{aligned} B &= \frac{\mu_0}{4\pi} \frac{I}{r} 2\pi \\ B &= \frac{\mu_0 I}{2r} \end{aligned} \quad \text{--- (10.49)}$$



Use your brain power

We have seen that in case of parallel conducting wires carrying steady currents, the Biot-Savart law and the Lorentz force law give the result in Eq. (10.44A):

$$F_{21} = -F_{12}$$

Is this consistent with Newton's third law? (Consider for example the gravitational pull experienced by the Earth towards the Sun and that by the Sun towards the Earth.)

Example 10.5: A wire has 2 straight sections and one arc as shown in the figure. Determine the direction and magnitude of the magnetic field produced at the centre O of the semicircle by the three sections individually and the total.

Solution: We apply the Biot-Savart law to the 3 sections of the wire.

For the section (i) and (iii) the angle between the current-length elements $I d\vec{l}$ and \vec{R} is 180° and 0° , respectively.

$$\therefore dB = \frac{\mu_0}{4\pi} \frac{Idl \sin(180)^\circ}{R^2} = 0 = \frac{\mu_0}{4\pi} \frac{Idl \sin(0)^\circ}{R^2}$$

For section (ii), $d\vec{l}$ is always perpendicular

to \vec{R} .

$$\therefore dB = \frac{\mu_0}{4\pi} \frac{Idl \sin(90^\circ)}{R^2} = \frac{\mu_0}{4\pi} \frac{Idl}{R^2}$$

$$\text{Integrating, } B = \frac{\mu_0}{4\pi} \frac{I}{R^2} \int_0^{\pi R} dl = \frac{\mu_0}{4\pi} \frac{I}{R^2} \pi R$$

$$\therefore B = \frac{\mu_0 I}{4R}$$

\therefore For the sections (i), and (iii), $B = 0$, for section (ii) $B = \frac{\mu_0 I}{4R}$ at the point O.

Total $B = 0 + \frac{\mu_0 I}{4R} + 0 = \frac{\mu_0 I}{4R}$; Direction of B is coming out of the plane of the paper.

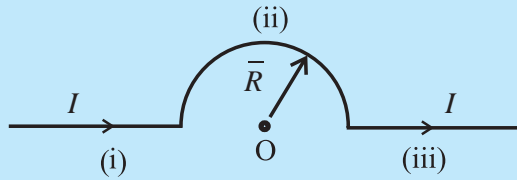

10.13: Axial Magnetic Field Produced by Current in a Circular Loop:

Here we shall obtain the magnetic field, due to current in a circular loop, at different points along its axis. We assume that the current is steady.

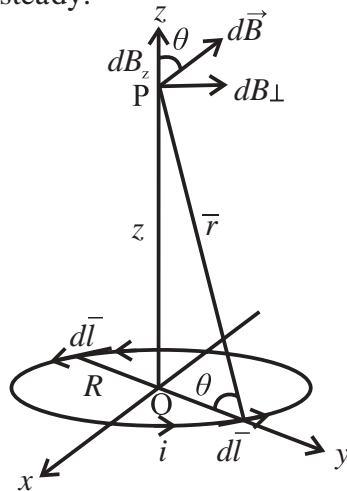

Fig. 10.19: Magnetic field on the axis of a circular current loop of radius R.

Figure 10.19 shows a circular loop of a wire carrying a current I . The loop itself is in the x - y plane with its centre at the origin O . The radius of the loop, carrying a steady current I , is R . We need to calculate the magnetic field at a point P on the Z -axis, at a distance \vec{r} from

the element $d\vec{l}$ on the loop. Using Biot-Savart law, the magnitude of the magnetic field dB is given by

$$dB = \frac{\mu_0}{4\pi} I \frac{|d\vec{l} \times \vec{r}|}{r^3} \quad \text{--- (10.50)}$$

We have $r^2 = R^2 + z^2$

Any element $d\vec{l}$ will always be perpendicular to the vector \vec{r} from the element to the point P . The element $d\vec{l}$ is in the x - y plane, while the vector \vec{r} is in the y - z plane. Hence $d\vec{l} \times \vec{r} = dl \cdot r$

$$\therefore dB = \frac{\mu_0}{4\pi} I \frac{dl}{r^2} \quad \text{--- (10.51)}$$

$$= \frac{\mu_0}{4\pi} I \frac{dl}{(z^2 + R^2)} \quad \text{--- (10.52)}$$

The direction of $d\vec{B}$ is perpendicular to the plane formed by $d\vec{l}$ and \vec{r} . Its z component is dB_z and the component perpendicular to the z -axis is dB_\perp . The components dB_\perp when summed over, yield zero as they cancel out due to symmetry. This can be easily seen from the diametrically opposite element $d\vec{l}$ giving dB_\perp opposite to that due to $d\vec{l}$. Hence, only z component remains.

\therefore The net contribution along the z axis is obtained by integrating $dB_z = dB \cos \theta$ over the entire loop.

From Fig. 10.19,

$$\cos \theta = \frac{R}{r} = \frac{R}{\sqrt{z^2 + R^2}}$$

$$\therefore B_z = \int dB_z = \frac{\mu_0}{4\pi} I \int \frac{dl}{(z^2 + R^2)} \cdot \cos \theta$$

$$= \frac{\mu_0}{4\pi} I \int \frac{R dl}{(z^2 + R^2)^{3/2}}$$

$$= \frac{\mu_0}{4\pi} \frac{IR}{(z^2 + R^2)^{3/2}} \cdot 2\pi R$$

$$B_z = \frac{\mu_0}{2} \frac{IR^2}{(z^2 + R^2)^{3/2}} \quad \text{--- (10.53)}$$

This is the magnitude of the magnetic field due to current I in the loop of radius R , on a point at P on the z axis of the loop.



Do you know?

So far we have used the constant μ_0 everywhere. This means in each such case, we have carried out the evaluation in free space (vacuum). μ_0 is the permeability of free space.

10.14 Magnetic Lines for a Current Loop:

We know that the magnetic field at a point P on the axis is given by Eq. (10.53) as

$$B_z = \frac{\mu_0 IR^2}{2(z^2 + R^2)^{3/2}}$$

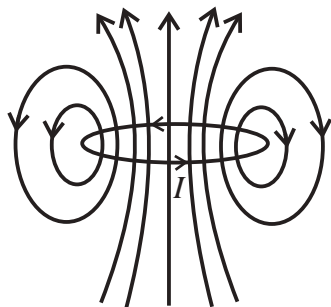

Fig. 10.20: Magnetic field lines for a current loop.

As a special case, the field at the centre of the loop is obtained from the above equation by letting $z = 0$:

$$B_0 = \frac{\mu_0 I}{2R} \quad \text{--- (10.54)}$$

For a coil of N turns,

$$B = \frac{\mu_0 NI}{2R} \quad \text{--- (10.55)}$$

The magnetic field lines from a circular loop are depicted in Fig. 10.20. The direction of the field is as per the right hand thumb rule: Curl the palm of your right hand along the circular wire with the fingers in the direction of the current. The stretched right hand thumb then gives the direction of the magnetic field (Fig. 10.21). Thus, the upper part of the loop seen in Fig. 10.20 may be regarded as the North pole and the lower part as the South pole of a bar magnet.

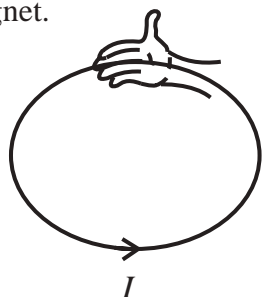

Fig. 10.21: The right hand thumb rule.

Circular loop carrying a current as a magnetic dipole: The behaviour of the magnetic field due to a circular current loop, at large distances is very similar to that due to electric field of an electric dipole. From the above equation for B_z , at large distance z from the loop along its axis,

$$z \gg R$$

$$\therefore B_z = \frac{\mu_0 IR^2}{2z^3}$$

The area of the loop is $A = \pi R^2$

$$\therefore B_z = \frac{\mu_0 IA}{2\pi z^3} \text{ at } z \gg R \quad \text{--- (10.56)}$$



Can you recall?

In XIth Std you have noted the analogy between the electrostatic quantities and magnetostatic quantities: The electrostatic analogue

The magnetic moment \vec{m} of a circular loop is defined as $\vec{m} = I\vec{A}$, where \vec{A} is a vector of magnitude A and direction perpendicular to A . Using Eq. (10.56),

$$\therefore B_z = \frac{\mu_0}{2\pi} \frac{m}{z^3}$$

$$\vec{B}_z = \frac{\mu_0}{4\pi} \frac{2\vec{m}}{z^3} \quad \text{--- (10.57)}$$

Note that \vec{B}_z and \vec{m} are in the same direction, perpendicular to the plane of the loop.

Using electrostatic analogue,

$$\vec{E} = \frac{2\vec{p}}{4\pi\epsilon_0 z^3},$$

which is the electric field at an axial point of an electric dipole.



Use your brain power

- Using electrostatic analogue, obtain the magnetic field at a distance x on the perpendicular bisector of a magnetic dipole \vec{m} . For $x \gg R$, verify that $\vec{B} = \frac{\mu_0}{4\pi} \frac{\vec{m}}{x^3}$
- What is the fundamental difference between an electric dipole and a magnetic dipole?

Example 10.6: Consider a closely wound 1000 turn coil, having radius of 1m. If a current of 10A passes through the coil, what will be the magnitude of the magnetic field at the centre?

Solution: $N = 1000$, $R = 100$ cm, $I = 10$ A.
Using Eq. (10.50),

$$B = \frac{\mu_0 NI}{2R} = \frac{4\pi \times 10^{-7} \times 10^3 \times 10}{2 \times 1} = 2\pi \times 10^{-3} = 6.28 \times 10^{-3} T$$

10.15 Ampere's Law:

We know that if a distribution of charges is given, one can obtain the electric field by using the inverse square law. If the distribution of charges is planar, or has spherical or cylindrical symmetry, then with the help of Gauss' Law we can find the net electric field with relative ease. On similar note, we can obtain the magnetic field produced by a distribution of currents (not charges!).

Again, if the distribution of currents has some symmetry, then we can use Ampere's law to find out the magnetic field with fair ease, as you will see below. You have studied Biot-Savart law and its consequences. The Ampere's law can be derived from Biot-Savart Law. The law is due to Andre' Marie Ampere (1775-1836) after whom the SI unit of current is named.

The Ampere's law is:

$$\oint \vec{B} \cdot d\vec{s} = \mu_0 I \quad \text{--- (10.58)}$$

The sign \oint indicates that the integral is to be evaluated over a closed loop called **Amperian loop**. The current I on the right hand side is the net current encircled by the Amperian loop. In an example shown in Fig. 10.22, cross-sections of four long straight wires carrying currents I_1, I_2, I_3, I_4 into or out of the plane of the paper are shown. An Amperian loop is drawn to encircle 3 of the current wires and not the fourth one. As the current goes perpendicular to the plane of the paper, \vec{B} is

in the plane of the paper even if its direction is unknown. The length element on the Amperian loop is $d\vec{l}$ (in the plane of the paper).

$$\vec{B} \cdot d\vec{l} = B dl \cos \theta, \text{ and from Eq. (10.58),}$$

$$\oint \vec{B} \cdot d\vec{l} = \oint B \cos \theta dl = \mu_0 I \quad \text{--- (10.59)}$$

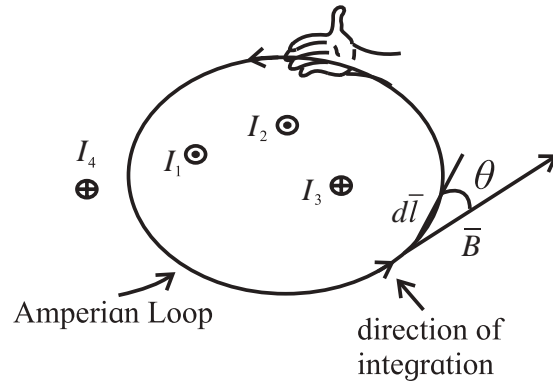

Fig. 10.22: Amperian Loop.

Thus the integration is over the product of length dl of the Amperian loop and the component of the magnetic field $B \cos \theta$, tangent to the loop.

We use the curled-palm right hand rule so that we can mark the currents with positive sign or negative sign. Curl the right hand palm along the Amperian loop, with fingers in the direction of integration. Then a current in the direction of the stretched thumb is assigned positive sign and the current in the direction opposite to the stretched thumb is assigned negative sign.

For the distribution of currents as shown in Fig. 10.22, I_1 and I_2 are coming out of the paper, (\odot) parallel to the stretched thumb. Hence these are positive. I_3 , on the other hand is going into the plane of the paper (\otimes). Thus, it is negative.

$$\therefore \oint B \cos \theta dl = \mu_0 (I_1 + I_2 - I_3) \quad \text{--- (10.60)}$$

The Current I_4 is not within the Amperian loop.

As the integration is over a full loop, contributions of I_4 to B cancel out.

Equation (10.58) represents Ampere's law or Ampere's circuital law.

An as application of Ampere's law let us

consider a long straight wire carrying a current I (Fig. 10.23). \vec{B} and $d\vec{l}$ are tangential to the Amperian loop which is a circle here.

$$\therefore \vec{B} \cdot d\vec{l} = B dl = B.r.d\theta$$

The field \vec{B} at a distance r from the wire is given by

$$B = \frac{\mu_0 I}{2\pi r} \quad \text{--- (10.61)}$$

$$\therefore \oint_c \vec{B} \cdot d\vec{l} = \int_0^{2\pi} \frac{\mu_0 I}{2\pi r} r d\theta = \mu_0 I \quad \text{--- (10.62)}$$

This is in agreement with the Ampere's law. Equation (10.61) shows that the magnetic field B of an infinitely long wire is proportional to the current I but inversely proportional to the distance from the wire, as seen earlier.

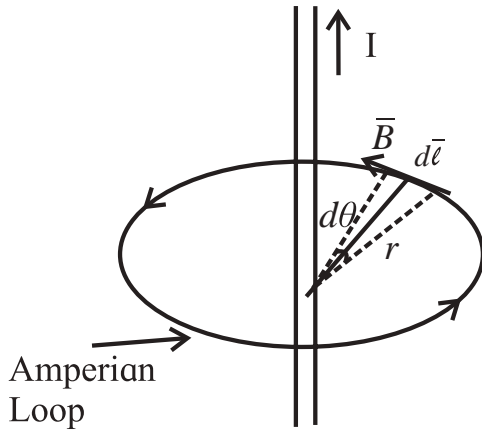
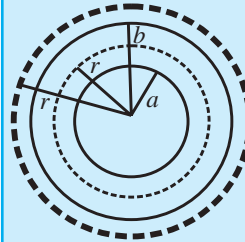

Fig. 10.23: Long straight current carrying wire.

You have studied Gauss' law in electrostatics as well as magnetism. The above example shows that if the distribution of currents has a high degree of symmetry such as cylindrical symmetry in case of a long wire, then the magnetic field for the given distribution of currents can be easily calculated. It will then become unnecessary to solve the integrals which appear in the Biot-Savart law.

We note here that the Biot-Savart law plays a role in magnetostatics that Coulomb's law plays in electrostatics. On parallel lines, we can say that what the role Gauss' law plays in electrostatics, plays the Ampere's law in magnetostatics.

Example 10.7: A coaxial cable consists of a central conducting core wire of radius a and a coaxial cylindrical outer conductor of radius b (see figure). The two conductors carry an equal current I in opposite directions in and out of the plane of the paper. What will be the magnitude of the magnetic field B for (i) $a < r < b$ and (ii) $b < r$? What will be its direction?



Solution: By symmetry, B will be tangential to any circle centred on the central conductor. In order to apply the

Ampere's law, consider a circle of radius r such that $a < r < b$.

$$\therefore \oint \vec{B} \cdot d\vec{l} = \mu_0 I$$

$$\therefore B.2\pi r = \mu_0 I$$

$$\therefore B = \frac{\mu_0 I}{2\pi r}, \quad a < r < b$$

For $r > b$,

$$\therefore \oint \vec{B} \cdot d\vec{l} = \mu_0 (I - I) = 0 \quad (\because \text{The two current are equal and opposite})$$

$$\therefore B.2\pi r = 0 \quad r > b$$

(Try to solve this using Biot-Savart Law !)

10.16 Magnetic Field of a Solenoid and a Toroid: (a) Solenoid:

You have learnt about a solenoid in XIth Std. qualitatively. Consider a long, closely wound helical coil of a conducting wire. We assume that the diameter of the coil is much smaller than its length. Figure 10.24 shows the schematic diagram of a cross section of a current carrying solenoid. The density of the magnetic field lines along the axis of the solenoid within the solenoid and at a certain distance away from the wire, is uniform. Hence the magnetic field B is parallel to the axis of the solenoid. The lines are widely spaced outside the solenoid and hence the magnetic field is weak there.

For a real solenoid of finite length, magnetic field is uniform and has a good

strength at the centre and comparatively weak at the outside of the coil.

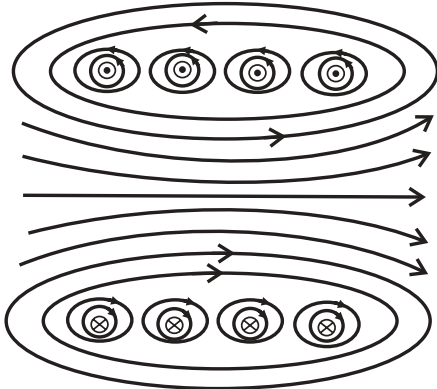

Fig. 10.24: Schematic diagram of a cross section of a current carrying Solenoid.

Let us consider an ideal solenoid as shown in Fig. 10.25.

For the application of the Ampere's law, an Amperian loop is drawn as shown in Fig. 10.25. From Eq. (10.58),

$$\oint \vec{B} \cdot d\vec{l} = \mu_0 I$$

Over the rectangular loop abcd, the above integral takes the form

$$\int_a^b \vec{B} \cdot d\vec{l} + \int_b^c \vec{B} \cdot d\vec{l} + \int_c^d \vec{B} \cdot d\vec{l} + \int_d^a \vec{B} \cdot d\vec{l} = \mu_0 I \quad \text{--- (10.63)}$$



Do you know?

In an ideal solenoid, the length is infinite and the wire has a square cross section and is wound very closely (with a layer of insulating material in between these enamelled wires). The magnetic field inside the coil is then uniform and along the axis of the solenoid. Outside the solenoid, it is zero.

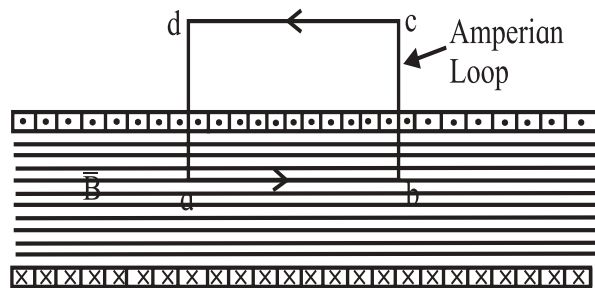

Fig. 10.25: Ampere's law applied to a part of a long ideal solenoid: The dots (.) show that the current is coming out of the plane of the paper and the crosses (x) show that the current is going into the plane of the paper, both in the coil of square cross section wire.

In the above equation, I is the net current encircled by the loop.

$$\therefore B.L + 0 + 0 + 0 = \mu_0 I \quad \text{--- (10.64)}$$

The second and fourth integrals are zero because \vec{B} and $d\vec{l}$ are perpendicular to each other. The third integral is zero because outside the solenoid, $B = 0$. We can obtain the net current I .

If the number of turns is n per unit length of the solenoid and the current flowing through the wire is i , then the net current coming out of the plane of the paper is

$$I = nLi$$

$$\therefore \text{From Eq. (10.64),}$$

$$BL = \mu_0 nLi$$

$$\therefore B = \mu_0 ni \quad \text{--- (10.65)}$$

Although the above result for B is obtained for an ideal solenoid, it is also valid for a realistic solenoid, particularly when applied to points in the middle of it but certainly not to points near the ends. Thus, a solenoid can be designed for a specific value of B by a choice of i and n .

(b) Toroid: A toroid is a solenoid of finite length bent into a hollow circular tube like structure similar to a pressurized rubber tube inside a tyre of vehicle. Schematic of a cross section of a toroid is shown in Fig. 10.26. By applying Ampere's law and taking into account the symmetry of this structure, we can obtain the magnetic field along the central axis of the tube in terms of the current. We construct a circular Amperian loop along the central axis of the tube, as shown in the figure.

The magnetic field lines are concentric circles in the toroid. The direction of the field is dictated by the direction of the current i in the coil around the toroid. Again, by the Ampere's law,

$$\oint \vec{B} \cdot d\vec{l} = \mu_0 I,$$

where I is the net current encircled by the loop.

$$B \cdot 2\pi R = \mu_0 iN \quad \text{--- (10.66)}$$

Here N is the total number of turns in the toroid as the integration is over the full length of the loop, $2\pi R$.

$$\therefore B = \frac{\mu_0 iN}{2\pi R} \quad \text{--- (10.67)}$$

From the Eq. (10.67), B is inversely proportional to R . Thus, unlike the solenoid, magnetic field is not constant over the cross section of the toroid.

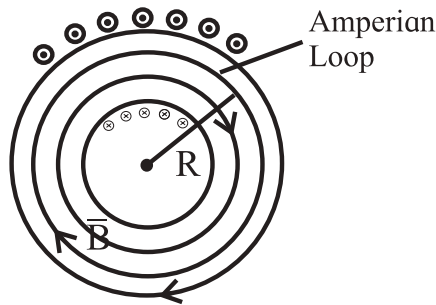

Fig. 10.26: Amperian loop along the central axis of the toroid.



Use your brain power

By making different choices for the Amperian loop, show that $B = 0$ for points outside an ideal toroid. What must be ideal toroid?

Example 10.8: A solenoid of length 25 cm has inner radius of 1 cm and is made up of 250 turns of copper wire. For a current of 3A in it, what will be the magnitude of the magnetic field inside the solenoid?

Solution: We use Eq. (10.65)

$$B = \mu_0 n i$$

$$B = 4\pi \times 10^{-7} \times \frac{250}{0.25} \times 3$$

$$B = 4\pi \times 10^{-7} \times 10^3 \times 3$$

$$\therefore B = 3.77 \times 10^{-3} \text{T}$$



Exercises

1. Choose the correct option.

- i) A conductor has 3 segments; two straight and of length L each and a semicircular with radius R . It carries a current I . What is the magnetic field B at point P ?

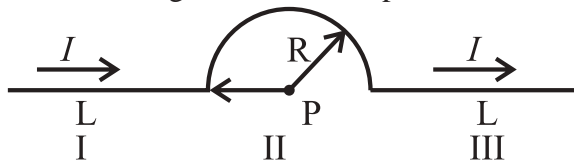

- (A) $\frac{\mu_0 I}{4\pi R}$ (B) $\frac{\mu_0 I}{4\pi R^2}$
 (C) $\frac{\mu_0 I}{4 R}$ (D) $\frac{\mu_0 I}{4\pi}$

- ii) Figure a, b show two Amperian loops associated with the conductors carrying current I in the sense shown. The $\oint \vec{B} \cdot d\vec{l}$ in the cases a and b will be, respectively,

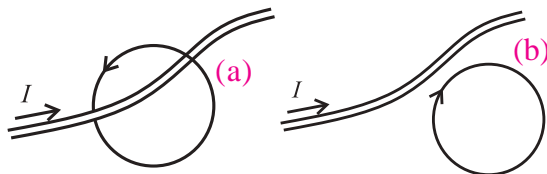

- (A) $-\mu_0 I, 0$ (B) $\mu_0 I, 0$
 (C) $0, \mu_0 I$ (D) $0, -\mu_0 I$

- iii) A proton enters a perpendicular uniform magnetic field B at origin along the positive x axis with a velocity v as shown

in the figure. Then it will follow the following path. [The magnetic field is directed into the paper].

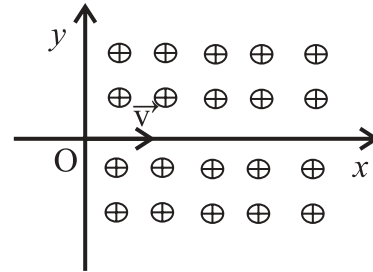

- (A) It will continue to move along positive x axis.
 (B) It will move along a curved path, bending towards positive x axis.
 (C) It will move along a curved path, bending towards negative y axis.
 (D) It will move along a sinusoidal path along the positive x axis.

- (iv) A conducting thick copper rod of length 1 m carries a current of 15 A and is located on the Earth's equator. There the magnetic flux lines of the Earth's magnetic field are horizontal, with the field of 1.3×10^{-4} T, south to north. The magnitude and direction of the force on the rod, when it is oriented so that current flows from west to east, are

- (A) 14×10^{-4} N, downward.
 (B) 20×10^{-4} N, downward.
 (C) 14×10^{-4} N, upward.
 (D) 20×10^{-4} N, upward.
- v) A charged particle is in motion having initial velocity \vec{v} when it enters into a region of uniform magnetic field perpendicular to \vec{v} . Because of the magnetic force the kinetic energy of the particle will
- (A) remain unchanged.
 (B) get reduced.
 (C) increase.
 (D) be reduced to zero.
2. A piece of straight wire has mass 20 g and length 1 m. It is to be levitated using a current of 1 A flowing through it and a perpendicular magnetic field B in a horizontal direction. What must be the magnetic of B ?

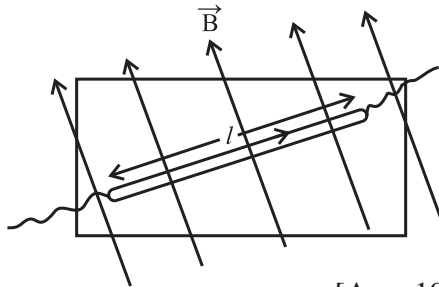

[Ans: 196 T]

3. Calculate the value of magnetic field at a distance of 2 cm from a very long straight wire carrying a current of 5 A (Given: $\mu_0 = 4\pi \times 10^{-7}$ Wb/Am).
- [Ans: 2.5×10^{-5} T]
4. An electron is moving with a speed of 3×10^7 m/s in a magnetic field of 6×10^{-4} T perpendicular to its path. What will be the radius of the path? What will be frequency and the energy in keV? [Given: mass of electron = 9×10^{-31} kg, charge $e = 1.6 \times 10^{-19}$ C, $1 \text{ eV} = 1.6 \times 10^{-19}$ J]
- [Ans: 18.7 MHz, 2.53 keV T]
5. An alpha particle (the nucleus of helium atom) (with charge +2) is accelerated and moves in a vacuum tube with kinetic energy = 10 MeV. It passes through a

uniform magnetic field of 1.88 T, and traces a circular path of radius 24.6 cm. Obtain the mass of the alpha particle. [$1 \text{ eV} = 1.6 \times 10^{-19}$ J, charge of electron = 1.6×10^{-19} C]

[Ans: 6.62×10^{-27} kg]

6. Two wires shown in the figure are connected in a series circuit and the same amount of current of 10 A passes through both, but in opposite directions. Separation between the two wires is 8 mm. The length AB is $S = 22$ cm. Obtain the direction and magnitude of the magnetic field due to current in wire 2 on the section AB of wire 1. Also obtain the magnitude and direction of the force on wire 1. [$\mu_0 = 4\pi \times 10^{-7}$ T.m/A]

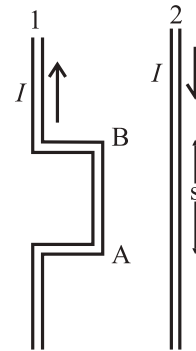
[Ans: Repulsive, 2.75×10^{-4} kg]

7. A very long straight wire carries a current 5.2 A. What is the magnitude of the magnetic field at a distance 3.1 cm from the wire? [$\mu_0 = 4\pi \times 10^{-7}$ T.m/A]
- [Ans: 8.35×10^{-5} T]
8. Current of equal magnitude flows through two long parallel wires having separation of 1.35 cm. If the force per unit length on each of the wires is 4.76×10^{-2} N, what must be I ?
- [Ans: 56.7 A]
9. Magnetic field at a distance 2.4 cm from a long straight wire is $16 \mu\text{T}$. What must be current through the wire?
- [Ans: 1.92 A]
10. The magnetic field at the centre of a circular current carrying loop of radius 12.3 cm is 6.4×10^{-6} T. What will be the magnetic moment of the loop?
- [Ans: 5.954×10^{-2} A.m²]

11. A circular loop of radius 9.7 cm carries a current 2.3 A. Obtain the magnitude of the magnetic field (a) at the centre of the loop and (b) at a distance of 9.7 cm from the centre of the loop but on the axis.

[Ans: 1.49×10^{-5} T, 1.68×10^{-6} T]

12. A circular coil of wire is made up of 100 turns, each of radius 8.0 cm. If a current of 0.40 A passes through it, what be the magnetic field at the centre of the coil?

[Ans: 3.142×10^{-4} T]

13. For proton acceleration, a cyclotron is used in which a magnetic field of 1.4 Wb/m^2 is applied. Find the time period for reversing the electric field between the two Ds.

[Ans: 2.34×10^{-8} s]

14. A moving coil galvanometer has been fitted with a rectangular coil having 50 turns and dimensions $5 \text{ cm} \times 3 \text{ cm}$. The radial magnetic field in which the coil is suspended is of 0.05 Wb/m^2 . The torsional constant of the spring is $1.5 \times 10^{-9} \text{ Nm/degree}$. Obtain the current required to be passed through the galvanometer so as to produce a deflection of 30° .

[Ans: 1.2×10^{-5} A]

15. A solenoid of length π m and 5 cm in diameter has winding of 1000 turns and carries a current of 5 A. Calculate the magnetic field at its centre along the axis.

[Ans: 2×10^{-3}]

16. A toroid of narrow radius of 10 cm has 1000 turns of wire. For a magnetic field of $5 \times 10^{-2} \text{ T}$ along its axis, how much current is required to be passed through the wire?

[Ans: 25 A]

17. In a cyclotron protons are to be accelerated. Radius of its D is 60 cm. and its oscillator frequency is 10 MHz. What will be the kinetic energy of the proton thus accelerated?

(Proton mass = $1.67 \times 10^{-27} \text{ kg}$,

$e = 1.60 \times 10^{-19} \text{ C}$, $eV = 1.6 \times 10^{-19} \text{ J}$)

[Ans: 7.515 MeV]

18. A wire loop of the form shown in the figure carries a current I . Obtain the magnitude and direction of the magnetic field at P.

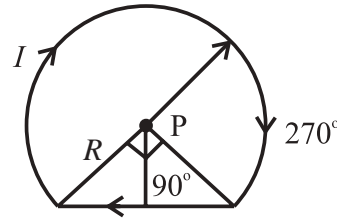

[Ans: $B = \frac{\mu_0 I}{4\pi R} \left[\frac{3\pi}{2} + \sqrt{2} \right]$]

19. Two long parallel wires going into the plane of the paper are separated by a distance R , and carry a current I each in the same direction. Show that the magnitude of the magnetic field at a point P equidistant from the wires and subtending angle θ from the plane containing the wires, is $B = \frac{\mu_0 I}{\pi R} \sin 2\theta$. What is the direction of the magnetic field?

20. Figure shows a cylindrical wire of diameter a , carrying a current I . The current density which is in the direction of the central axis of the wire varies linearly with radial distance r from the axis according to the relation $J = J_0 r/a$. Obtain the magnetic field B inside the wire at a distance r from its centre.

[Ans: $B = \frac{J_0 \mu_0 r^2}{3a}$]



21. In the above problem, what will be the magnetic field B inside the wire at a distance r from its centre, if the current density J is uniform across the cross section of the wire?

[Ans: $B = \frac{\mu_0 J r}{\pi}$]

11. Magnetic Materials



Can you recall?

1. What are magnetic lines of force?
2. Why magnetic monopoles do not exist?
3. Which materials are used in making magnetic compass needle?

11.1 Introduction:

You have studied about magnetic dipole and dipole moment due to a short bar magnet. Also you have studied about magnetic field due to a short bar magnet at any point in its vicinity. When such a small bar magnet is suspended freely, it remains along the geographic North South direction. (*This property can be readily used in Navigation.*)

In the present Chapter you will learn about the behaviour of a short bar magnet kept in two mutually perpendicular magnetic fields. You will also learn about different types of magnetism, viz. diamagnetism, paramagnetism and ferromagnetism with their properties and examples. At the end you will learn about the applications of magnetism such as permanent magnet, electromagnet, and magnetic shielding.



Activity

You have already studied in earlier classes that a short bar magnet suspended freely always aligns in North South direction (as shown in Fig. 11.1). Now if you try to forcefully move and bring it in the direction along East West and leave it free, you will observe that the magnet starts turning about the axis of suspension. Do you know from where does the torque which is necessary for rotational motion come from? (as studied in rotational dynamics a torque is necessary for rotational motion).

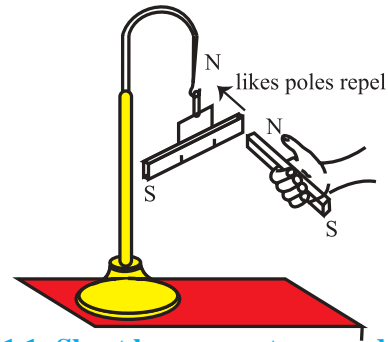

Fig. 11.1: Short bar magnet suspended freely with an inextensible string.



Try this

Now we will extend the above experiment further by bringing another short bar magnet near to the freely suspended magnet. Observe the change when the like and unlike poles of the two magnets are brought near each other. Draw conclusion. Does the suspended magnet rotate continuously or rotate through certain angle and remain stable?

11.2 Torque Acting on a Magnetic Dipole in a Uniform Magnetic Field:

You have studied in the previous Chapter of that the torque acting on a rectangular current carrying coil kept in a uniform magnetic field is given by

$$\tau = \vec{m} \times \vec{B}$$

$$\tau = mB \sin \theta, \quad \dots (11.1)$$

where θ is the angle between \vec{m} and \vec{B} , the magnetic dipole moment and the external applied uniform magnetic field, respectively as shown in Fig. 11.2. The same can be observed when a small bar magnet is placed in a uniform magnetic field. The forces exerted on the poles of the bar magnet due to magnetic field are along different lines of action. These forces form a couple. As studied earlier, the couple produces pure rotational motion. Analogous to rectangular magnetic coil in uniform magnetic field, the bar magnet will follow the same Eq. (11.1).

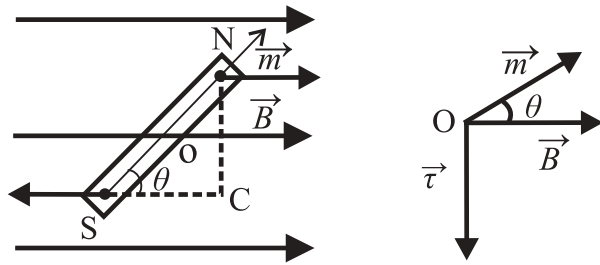

Fig. 11.2: Magnet kept in a Uniform Magnetic field.

$\tau = mB \sin \theta$ (m is the magnetic dipole moment of bar magnet and B the uniform magnetic field).

Due to the torque the bar magnet will undergo rotational motion. Whenever a displacement (linear or angular) is taking place, work is being done. Such work is stored in the form of potential energy in the new position (refer to Chapter 8). When the electric dipole is kept in the electric field the energy stored is the electrostatic Potential energy.

Magnetic potential energy

$$U_m = \int_0^\theta \tau(\theta) d\theta \quad \text{--- (11.2)}$$

$$U_m = \int_0^\theta mB \sin \theta d\theta$$

$$U_m = -mB \cos \theta \quad \text{--- (11.3)}$$

Let us consider various positions of the magnet and find the potential energy in those positions.

Case 1- When $\theta = 0^\circ$, $\cos 0 = 1$ $U_m = -mB$ This is the position when \vec{m} and \vec{B} are parallel and bar magnet possess minimum potential energy and is in the most stable state.

Case 2- When $\theta = 180^\circ$, $\cos 180^\circ = -1$ $U_m = mB$. This is the position when \vec{m} and \vec{B} are antiparallel and bar magnet possesses maximum potential energy and thus is in the most unstable state.

Case 3- When $\theta = 90^\circ$, $\cos 90^\circ = 0$ $U_m = 0$ This is the position when bar magnet is aligned perpendicular to the direction of magnetic field.

The potential energy as function of θ is shown in Fig. 11.3.

As discussed in the activity earlier, suppose the bar magnet is suspended using in extensible string. When we perform similar

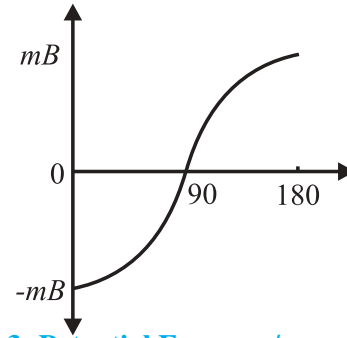

Fig. 11.3: Potential Energy v/s angular position of the magnet.

activity (Refer Fig. 11.1) we observe that the magnet rotates through angle and then becomes stationary. This happens because of the restoring torque as studied in Chapter 10 generated in the string opposite to the deflecting torque. In equilibrium both the torques balance.

$$\tau = I \frac{d^2\theta}{dt^2} \quad \text{--- (11.4)}$$

where I is moment of inertia of bar magnet and $\frac{d^2\theta}{dt^2}$ is the angular acceleration. As seen from Fig. (11.2), the direction of the torque acting on the magnet is clockwise. Now if one tries to rotate the magnet anticlockwise through an angle $d\theta$, then there will be a restoring torque acting as given by the equation, in opposite direction.

Thus we write the restoring torque

$$\tau = -mB \sin \theta \quad \text{--- (11.5)}$$

From the two equations we get

$$I \frac{d^2\theta}{dt^2} = -mB \sin \theta .$$

When the angular displacement θ is very small, $\sin \theta \approx \theta$ and the above equation can be written as

$$I \frac{d^2\theta}{dt^2} = -mB\theta$$

$$\frac{d^2\theta}{dt^2} = -\left(\frac{mB}{I}\right)\theta \quad \text{--- (11.6)}$$

The above equation has angular acceleration on the left hand side and angular displacement θ on the right hand side of equation with m , B and I being held constant.

This is the angular simple harmonic motion (S.H.M) (Chapter 5) analogous to linear S.H.M. governed by the equation

$$\frac{d^2x}{dt^2} = -\omega^2 x.$$

$$\text{Here } \omega^2 = \frac{mB}{I}$$

$$\therefore \omega = \sqrt{\frac{mB}{I}} \quad \text{--- (11.7)}$$

The time period of angular oscillations of the bar magnet will be

$$T = \frac{2\pi}{\omega} = 2\pi \sqrt{\frac{I}{mB}} \quad \text{--- (11.8)}$$

Vibration Magnetometer:



Vibration Magnetometer is used for the comparison of magnetic moments and magnetic field. This device works on the principle, that whenever a freely suspended magnet in a uniform magnetic field, is disturbed from its equilibrium positions, it starts vibrating about the mean position. It can be used to determine horizontal component of Earth's magnetic field.

Examples 11.1: A bar magnet of moment of inertia of 500 g cm^2 makes 10 oscillations per minute in a horizontal plane. What is its magnetic moment, if the horizontal component of earth's magnetic field is 0.36 gauss?

Given: Moment of Inertia $I = 500 \text{ g cm}^2$
Frequency $n = 10$ oscillation per minute
 $= 10/60$ oscillations per second

Time period $T = 6 \text{ sec}$

$B_H = 0.36 \text{ gauss}$

Solution: From Eq. (11.8),

$$m = \frac{4\pi^2 I}{T^2 B}$$

$$m = \frac{4 \times (3.14)^2 \times 500 \times 10^{-7}}{36 \times 0.36 \times 10^{-4}}$$

$$m = 1.52 \text{ Amp m}^2$$

Location of Magnetic poles of a Current Carrying Loop:

You have studied that a current carrying conductor produces magnetic field and if you bend the conductor in the form of loop, this loop, behaves like a bar magnet (as discussed in Chapter 10).



Observe and discuss

What is a North pole or South pole of a bar magnet? For understanding this, you just have to draw a circular loop on a plane glass plate and show the direction of current (say clockwise direction). Now place on it a wire loop having clockwise current flowing through it. According to right hand rule, the top surface will behave as a South pole. Now just turn the glass and see the same loop through other surface of glass. You will find that the direction of current is in anticlockwise direction (in reality there is no change in the direction of current) and hence the loop side surface behaves like North pole.

11.3 Origin of Magnetism in Materials:

In order to understand magnetism in materials we have to use the basic concepts such as magnetic poles and magnetic dipole moment. In XIth Std., you have studied about the magnetic property of a short bar magnet such as its magnetic field along its axial or equatorial direction. What makes some material behave like a magnet while others don't? To understand it one must consider the building blocks of any material i.e., atoms. In an atom, negatively charged electrons are revolving about the nucleus (consisting of protons and neutrons). The details about it will be studied in Chapter 15. You have studied in the periodic table in Chemistry in XIth Std. that chemical properties are dominated by the electrons orbiting in the outermost orbit of the

atom. This also applies to magnetic properties as described below.

11.3.1 Magnetic Moment of an Electron Revolving Around the Nucleus of an Atom:

Let us consider an electron revolving around positively charged nucleus in a circular orbit as a simple model. A (negatively charged) electron revolving in an orbit is equivalent to a tiny current loop. The magnetic dipole moment due to a current loop is given by $m_{orb} = IA$ (A is the area enclosed by the loop and I is the current). It is only a part of the magnetic moment of an atom and is referred to as orbital magnetic moment. An electron possesses an intrinsic angular momentum, the spin angular momentum. Spin magnetic dipole moment results from this intrinsic spin. Consider an electron moving with constant speed v in a circular orbit of radius r about the nucleus as shown in Fig. 11.4. If the electron travels a distance of $2\pi r$ (circumference of the circle) in time T , then its orbital speed $v = 2\pi r/T$. Thus the current I associated with this orbiting electron of charge e is

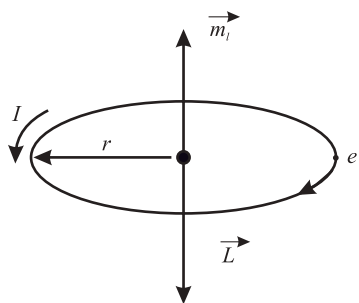

Fig. 11.4: Single electron revolving around the nucleus.

$$I = \frac{e}{T}$$

$$T = \frac{2\pi}{\omega} \text{ and } \omega = \frac{v}{r}, \text{ the angular speed}$$

$$I = \frac{e\omega}{2\pi} = \frac{ev}{2\pi r} \quad \text{--- (11.9)}$$

The **orbital magnetic moment** associated with orbital current loop is

$$m_{orb} = IA = \frac{ev}{2\pi r} \times \pi r^2 = \frac{1}{2} evr \quad \text{--- (11.10)}$$

For this electron, orbital angular momentum is

$$L = m_e vr,$$

where m_e is the mass of an electron.

Hence the orbital magnetic moment, Eq. (11.10) can be written as

$$m_{orb} = \left(\frac{e}{2m_e}\right)(m_e vr) = \left(\frac{e}{2m_e}\right)L \quad \text{--- (11.11)}$$

This equation shows that orbital magnetic moment is proportional to the angular momentum. But as the electron bears negative charge the vector m_{orb} and L are in opposite directions and perpendicular to the plane of the orbit. Hence, vectorially $\vec{m}_{orb} = -\frac{e}{2m_e}\vec{L}$. The same result is obtained using quantum mechanics

The ratio $\frac{e}{2m_e}$ is called gyromagnetic ratio.

For an electron revolving in a circular orbit, the angular momentum is integral (n) multiple of $h/2\pi$. (from the second postulate of Bohr theory of hydrogen atom).

$$L = m_e vr = \frac{nh}{2\pi}$$

Substituting the value of L in Eq. (11.11) we get

$$m_{orb} = \frac{enh}{4\pi m_e}$$

For the 1st orbit $n = 1$, giving $m_{orb} = \frac{eh}{4\pi m_e}$,

The quantity $\frac{eh}{4\pi m_e}$ is called Bohr Magneton.

The value of Bohr Magneton is 9.274×10^{-24} A /m². The magnetic moment of an atom is stated in terms of Bohr Magnetons (B.M.).

Example 11.2: Calculate the gyromagnetic ratio of electron (given $e = 1.6 \times 10^{-19}$ C, $m_e = 9.1 \times 10^{-31}$ kg)

Solution:

$$\begin{aligned} \text{Gyromagnetic ratio} &= \frac{e}{2m_e} \\ &= 1.6 \times 10^{-19} / (2 \times 9.1 \times 10^{-31}) \\ &= 8.8 \times 10^{10} \text{ C kg}^{-1} \end{aligned}$$



Do you know?

Effective magneton numbers for iron group ions (No. of Bohr magnetons)

Ion	Configuration	Effective magnetic moment in terms of Bohr magneton (B.M) (Experimental values)
Fe ³⁺	3d ⁵	5.9
Fe ²⁺	3d ⁶	5.4
Co ²⁺	3d ⁷	4.8
N ²⁺	3d ⁸	3.2

(Courtesy: Introduction to solid state physics by Charles Kittel, pg. 306)

These magnetic moments are calculated from the experimental value of magnetic susceptibility. In several ions the magnetic moment is due to both orbital and spin angular momenta.

As stated earlier, apart from the orbital motion, electron spin also contributes to the resultant magnetic moment of an atom. Vector sum of these two moments is the total magnetic moment of the atom.



Do you know?

Two possible orientations of spin angular momentum (\vec{s}) of an electron in an external magnetic field. Note that the

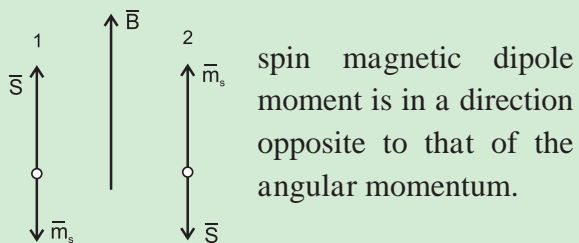

You have studied Pauli's exclusion principle. According to it, no two electrons can have the same set of quantum numbers viz. n , l , m_l and m_s defining a state. Therefore, the resultant magnetic dipole moment for these atoms with a pair of electrons in the same state, defined by n , l and m_l , will be zero as discussed in the box below.

The atoms with odd number of electrons in their outermost orbit will possess nonzero

resultant magnetic moment. Inner orbits are completely filled and hence do not contribute to the total magnetic moment of the atom.



Observe and discuss

Let us see whether the given atom has paired electron or unpaired electrons in the outermost orbit. We will follow three steps-

- 1) Write electronic configuration
- 2) Draw valence orbital
- 3) Identify if unpaired electron exist

Ex. Chlorine Cl (it has total 17 electrons)

- 1) electronic configuration $1s^2 2s^2 2p^6 3s^2 3p^5$
- 2) ignoring inner completely filled orbitals and just considering valence electrons.

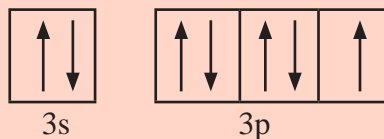

- 3) There is one unpaired electron.

In a similar manner study Fe, Zn, He, B, Ni and draw your conclusions.

11.4 Magnetization and Magnetic Intensity:

In the earlier section you have seen that atoms with unpaired electrons have a net magnetic dipole moment. The bulk material is made up of a large number of such atoms each having an inherent magnetic moment. The magnetic dipole moments are randomly oriented and hence the net dipole moment of many of the bulk materials is zero. For some materials (such as Fe₃O₄), the vector addition of all these magnetic dipole moments may not be zero. Such materials have a net magnetic moment. The ratio of magnetic moment to the volume of the material is called magnetization .

$$M = m_{\text{net}} / \text{volume} \quad \text{--- (11.12)}$$

M is vector quantity having dimension [$L^{-1} A$ and SI units $A m^{-1}$].

Consider a rod of such a material with some net magnetization, placed in a solenoid with n turns per unit length, and carrying current I . Magnetic field inside the solenoid is given by

$$B_0 = \mu_0 n I$$

Let us denote the magnetic field due to the material kept inside the solenoid by B_m .

Thus, the net magnetic field inside the rod can be expressed as

$$B = B_0 + B_m \quad \text{--- (11.13)}$$

It has been observed that B_m is proportional to magnetisation M of the material

$$B_m = \mu_0 M,$$

where μ_0 is permeability of free space.

$$\therefore B = \mu_0 n I + \mu_0 M \quad \text{--- (11.14)}$$

Here we will introduce one more quantity called magnetic field intensity H , where $H = nI$. The noticeable difference between the expression for B and H is that H does not depend on the material rod which is placed inside the solenoid.

$$B = \mu_0 H + \mu_0 M$$

$$B = \mu_0 (H + M) \quad \text{--- (11.15)}$$

$$\therefore H = \frac{B}{\mu_0} - M \quad \text{--- (11.16)}$$

From the above expression we conclude that H and M have the same unit i.e., ampere per metre, and also have the same dimensions. Thus the magnetic field induced in the material (B) depends on H and M . Further it is observed that if H is not too strong the magnetization M induced in the material is proportional to the magnetic intensity.

$$M = \chi H, \quad \text{--- (11.17)}$$

where χ is called Magnetic Susceptibility. It is a measure of the magnetic behaviour of the material in external applied magnetic field. χ is the ratio of two quantities with the same units (Am^{-1}). Hence it is a dimensionless constant.

From Eq. (11.15) and Eq. (11.17) we get

$$B = \mu_0 (H + \chi H)$$

$$B = \mu_0 (1 + \chi) H$$

$$B = \mu_0 \mu_r H \quad \text{--- (11.18)}$$

$$\mu_r = 1 + \chi$$

$$B = \mu H$$

$$\mu = \mu_0 \mu_r$$

$$\mu = \mu_0 (1 + \chi) \quad \text{--- (11.19)}$$

Here μ is magnetic permeability of the material analogous to ϵ in electrostatics and μ_r is the relative magnetic permeability of the substance.

Permeability and Permittivity:

Magnetic Permeability is a term analogous to permittivity in electrostatics. It basically tells us about the number of magnetic lines of force that are passing through a given substance when it is kept in an external magnetic field. The number is the indicator of the behaviour of the material in magnetic field. For superconductors $\chi = -1$. If you substitute in the Eq. (11.18), it is observed that permeability of material $\mu = 0$. This means no magnetic lines will pass through the superconductor.

Magnetic Susceptibility (χ) is the indicator of measure of the response of a given material to the external applied magnetic field. In other words it indicates as to how much magnetization will be produced in a given substance when kept in an external magnetic field. Again it is analogous to electrical susceptibility. This means when the substance is kept in a magnetic field, the atomic dipole moments either align or oppose the external magnetic field. If the atomic dipole moments of the substance are opposing the field, χ is observed to be negative, and if the atomic dipole moments align themselves in the direction of field, χ is observed to be positive. The number of atomic dipole moments of getting aligned in the direction of the applied magnetic field is proportional to χ . It is large for soft iron ($\chi > 1000$).

Example 11.2: The region inside a current carrying toroid winding is filled with Aluminium having susceptibility $\chi = 2.3 \times 10^{-5}$. What is the percentage increase in the magnetic field in the presence of

Aluminium over that without it?

Solution: The magnetic field inside the solenoid without Aluminium $B_0 = \mu_0 H$

The magnetic field inside the solenoid with Aluminium $B = \mu H$

$$\frac{B - B_0}{B_0} = \frac{\mu - \mu_0}{\mu_0}$$

$$\mu = \mu_0(1 + \chi)$$

$$\frac{\mu}{\mu_0} - 1 = \chi$$

$$\frac{\mu - \mu_0}{\mu_0} = \chi$$

therefore $\frac{B - B_0}{B_0} = \frac{\mu - \mu_0}{\mu_0} = \chi$

Percentage increase in the magnetic field after inserting Aluminium is

$$\frac{B - B_0}{B_0} \times 100 = 2.3 \times 10^{-5} \times 100 = 0.0023 \%$$

Table 11.1: Magnetic susceptibility of some materials

Diamagnetic Substance	χ	Paramagnetic Substance	χ
Silicon	-4.2×10^{-6}	Aluminium	2.3×10^{-5}
Bismuth	-1.66×10^{-5}	Calcium	1.9×10^{-5}
Copper	-9.8×10^{-6}	Chromium	2.7×10^{-4}
Diamond	-2.2×10^{-5}	Lithium	2.1×10^{-5}
Gold	-3.6×10^{-5}	Magnesium	1.2×10^{-5}
Lead	-1.7×10^{-5}	Niobium	2.6×10^{-5}
Mercury	-2.9×10^{-5}	Oxygen (STP)	2.1×10^{-6}
Nitrogen	-5.0×10^{-9}	Platinum	2.9×10^{-4}

11.5 Magnetic Properties of Materials:

The behaviour of a material in presence of external magnetic field classifies materials broadly into diamagnetic, paramagnetic and ferromagnetic materials. Magnetic susceptibility for diamagnetic material is negative and for paramagnetic positive but small. For ferromagnetic materials it is positive and large.

Table 11.2: Range of magnetic susceptibility of diamagnetic, paramagnetic and ferromagnetic materials

Types of material	χ
Diamagnetic	$-10^{-3} - -10^{-5}$
Paramagnetic	$0 - 10^{-3}$
Ferromagnetic	$10^2 - 10^3$

11.5.1 Diamagnetism:

In the earlier section it is discussed that atoms/molecules with completely filled electron orbit possess no net magnetic dipole moment. Such materials behave as diamagnetic materials. When these materials are placed in external magnetic field they move from the stronger part of magnetic field to the weaker part of magnetic field. Unlike magnets attracting magnetic material, these materials are repelled by a magnet.

The simplest explanation for diamagnetism could be given using paired electron orbit. As discussed earlier, the net magnetic moment of such atoms is zero. When the orbiting electron or current loop is brought in external magnetic field, the field induces a current as per Lenz's law (refer to Chapter 12) as shown in Fig. 11.5. The direction of induced current I_i , is such that the direction of magnetic field created by the current is opposite to the direction of applied external magnetic field. Out of the pair of orbits, for one loop where the direction of induced current is the same as that of loop current will find increase in current I , (Fig. 11.5 (b)) resulting in increase in magnetic dipole moment. For the current loop where the direction of induced current is opposite to direction of loop current, (Fig. 11.5 (a)) the net current is reduced, effectively reducing the magnetic dipole moment. This results in net magnetic dipole moment opposite to the direction of applied external magnetic field.

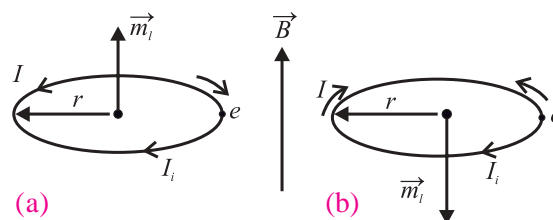

Fig. 11.5 The clockwise and anticlockwise motion of electron brought in a magnetic field.

Examples of diamagnetic materials are copper, gold metal, bismuth and many metals, lead, silicon, glass, water, wood, plastics etc. Diamagnetic property is present in all materials. In some, it is weaker than other properties such as paramagnetism or ferromagnetism which mask the diamagnetism.

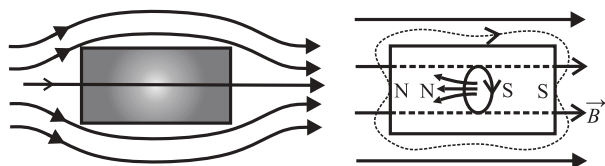

Fig. 11.6: Diamagnetic substance in uniform magnetic field.

When diamagnetic material is placed in an external magnetic field, the induced magnetic field inside the material repels the magnetic lines of forces resulting in reduction in magnetic field inside the material (See Fig. 11.6). Similarly when diamagnetic material is placed in non uniform magnetic field, it moves from stronger to weaker part of the field. If a diamagnetic liquid is filled in a U tube and one arm of the U tube is placed in an external magnetic field, the liquid is pushed in the arm which is outside the field. In general, these materials try to move to a place of weaker magnetic field. If a rod of diamagnetic material is suspended freely in the magnetic field it aligns itself in the direction perpendicular to the direction of external magnetic field. This is because there is a torque acting on induced dipole. As studied earlier, when the dipole is in a direction opposite to the direction of magnetic field it has a large magnetic potential energy and so is unstable. It will try to go into a position where the magnetic potential energy is least and that is when the rod is perpendicular to the direction of magnetic field. The magnetic susceptibility of diamagnetic material is negative.



Try this

Take a bar magnet (available in your laboratory), a small glass test tube with a cork partially filled with water and fixed on the piece of such a material say wood (float) that this system can float on water. Let the test tube and the float be kept floating in a water bath or some plastic tray containing water available in the laboratory. Bring the pole of the bar magnet near the water filled glass tube. Note your observation. Repeat the experiment without water filled in the test tube. Record your observation and draw conclusions.



Do you know?

When superconductors ($\chi = -1$) are placed in an external magnetic field, the field lines are completely expelled. The phenomenon of perfect diamagnetism in superconductor is called Meissner effect. *If a good electrical conductor is kept in a magnetic field, the field lines do penetrate the surface region to a certain extent.*

11.5.2 Paramagnetism:

In the earlier section you have studied that atoms/molecules having unpaired electrons possess a net magnetic dipole moment. As these dipole moments are randomly oriented, the resultant magnetic dipole moment of the material is, however, zero.

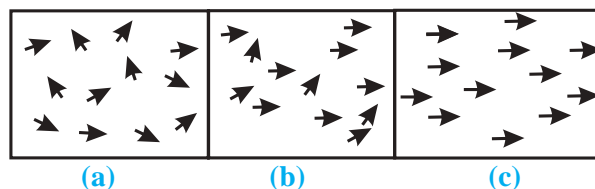

Fig. 11.7: Paramagnetic substance (a) No external Magnetic Field (b) Weak external magnetic Field (c) Strong external Magnetic Field.

As seen from Fig. 11.7 (a) and (b), each atom/molecule of a paramagnetic material possesses net magnetic dipole moment, but because of thermal agitation these are randomly

oriented. Due to this the net magnetic dipole moment of the material is zero in absence of an external magnetic field.

When such materials are placed in sufficiently strong external magnetic field at low temperature (to reduce thermal excitation) (Fig. 11.7 (c)), most of the magnetic dipoles align themselves in the direction of the applied field (to align in the direction corresponding to less potential energy). The field lines get closer inside such a material (see Fig. 11.8).

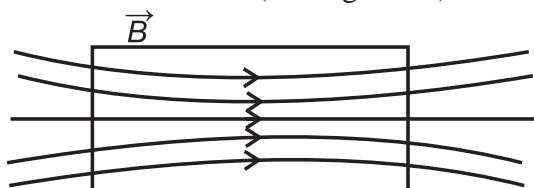

Fig . 11.8: Paramagnetic substance in external magnetic field.

When paramagnetic material is placed in a nonuniform magnetic field it tend to move itself from weaker region to stronger region. In other words, these materials are strongly attracted by external magnetic field. When a paramagnetic liquid is placed in a U tube manometer with a magnet kept in close vicinity of one of the arms, it is observed that the liquid rises into the arm close to the magnet.

When the external magnetic field is removed these magnetic dipoles get arranged themselves in random directions. Thus the net magnetic dipole moment is reduced to zero in the absence of a magnetic field. Metals such as magnesium, lithium, molybdenum, tantalum, and salts such as M_nSO_4 , H_2O and oxygen gas are examples of paramagnetic materials.

In 1895 Piere Curie observed that the magnetization M in a paramagnetic material is directly proportional to applied magnetic field B and inversely proportional to absolute temperature T of the material. This is known as Curie Law.

$$M = C \frac{B}{T} \quad \text{--- (11.20)}$$

$$B = \mu_0 H$$

$$M = C \frac{\mu_0 H}{T}$$

$$\frac{M}{H} = \chi = C \frac{\mu_0}{T}$$

$$\chi = \mu_r - 1 = C \frac{\mu_0}{T} \quad \text{--- (11.21)}$$

$$\chi \propto \frac{1}{T}$$

Thus when we increase the applied magnetic field and reduce the temperature, more number of magnetic moments align themselves in the direction of magnetic field resulting in increase in Magnetization.



Use your brain power

Classify the following atoms as diamagnetic or paramagnetic.

H, O, Zn, Fe, F, Ar, He

(Hint : Write down their electronic configurations)

Is it true that all substances with even number of electrons are diamagnetic?

11.5.3 Ferromagnetism:

Atoms/molecules of ferromagnetic material possess magnetic moments similar to those in paramagnetic materials. However, such substances exhibit strong magnetic properties and can become permanent magnets. Metals and rare earths such as iron, cobalt, nickel and some transition metal alloys exhibit ferromagnetism.

Domain theory: In ferromagnetic materials there is a strong interaction called exchange coupling or exchange interaction between neighbouring magnetic dipole moments.

Due to this interaction, small regions are formed in which all the atoms have their magnetic moments aligned in the same direction. Such a region is called a *domain* and the common direction of magnetic moment is called the domain axis. Domain size can be a fraction of a millimetre (10^{-6} - 10^{-4} m) and contains about 10^{10} - 10^{17} atoms. The boundary

between adjacent domains with a different orientation of magnetic moment is called a domain wall.



Do you know?

Exchange Interaction: This exchange interaction is stronger than usual dipole-dipole interaction by an order of magnitude. Due to this exchange interaction, all the atomic dipole moments in a domain get aligned with each other. Find out more about the origin of exchange interaction.

In unmagnetized state, the domain axes of different domains are oriented randomly, resulting in the net magnetic moment of the whole material to be zero, even if the magnetic moments of individual domains are nonzero as shown in Fig. 11.9 (a).

When an external magnetic field is applied, domains try to align themselves along the direction of the applied magnetic field. The number of domains aligning in that direction increases as magnetic field is increased. This process is referred to as flipping or domain rotation. When sufficiently high magnetic field is applied, all the domains coalesce together to form a giant domain as shown in Fig. 11.9 (b).

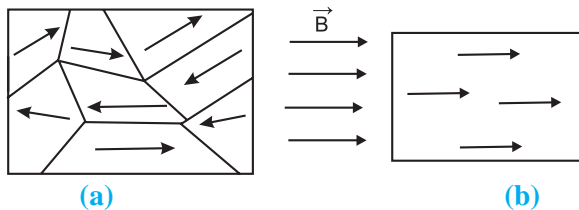

Fig. 11.9: Unmagnetised (a) and magnetised (b) ferromagnetic material with domains.

In nonuniform magnetic field ferromagnetic material tends to move from weaker part to stronger part of the field.

When the strong external magnetic field is completely removed, it does not set the domain boundaries back to original position and the net magnetic moment is still nonzero and ferromagnetic material is said to retain magnetization. Such materials are used in preparing permanent magnets.



Remember this

We have classified materials as diamagnetic, paramagnetic and ferromagnetic. However there exist additional types of magnetic materials such as ferrimagnetic, antiferrimagnetic, spin glass etc. with the exotic properties leading to various applications.

Example 11.3: A domain in ferromagnetic iron is in the form of cube of side $1 \mu\text{m}$. Estimate the number of iron atoms in the domain, maximum possible dipole moment and magnetisation of the domain. The molecular mass of iron is 55 g/mole and density is 7.9 g/cm^3 . Assume that each iron atom has a dipole moment of $9.27 \times 10^{-24} \text{ Am}^2$.

Solution: The volume of the cubic domain $V = (10^{-6})^3 = 10^{-18} \text{ m}^3 = 10^{-12} \text{ cm}^3$
 mass = volume \times density = $7.9 \times 10^{-12} \text{ g}$.
 An Avogadro number (6.023×10^{23}) of iron atoms has mass 55 g .

The number of atoms in the domain N

$$N = \frac{7.9 \times 10^{-12} \times 6.023 \times 10^{23}}{55} = 8.56 \times 10^{10}$$

The maximum possible dipole moment m_{max} is achieved for the case when all the atomic moments are perfectly aligned (though this will not be possible in reality).

$$m_{\text{max}} = 8.56 \times 10^{10} \times 9.27 \times 10^{-24} \\ = 8 \times 10^{-13} \text{ Am}^2$$

$$\text{Magnetisation } M = m_{\text{max}} / \text{domain volume} \\ = 8 \times 10^5 \text{ Am}^{-1}$$

11.5.4 Effect of Temperature:

Ferromagnetism depends upon temperature. As the temperature of a ferromagnetic material is increased, the domain structure starts distorting because the exchange coupling between neighbouring moments weakens. At a certain temperature, depending upon the material, the domain

structure collapses totally and the material behaves like paramagnetic material. The temperature at which a ferromagnetic material transforms into a paramagnetic substance is called Curie temperature (T_c) of that material.

The relation between the magnetic susceptibility of a material when it has acquired paramagnetic property and the temperature T is given by

$$\chi = \frac{C}{T - T_c} \quad \text{for } T > T_c \quad \text{--- (11.22)}$$

where C is a constant (Fig. 11.10).

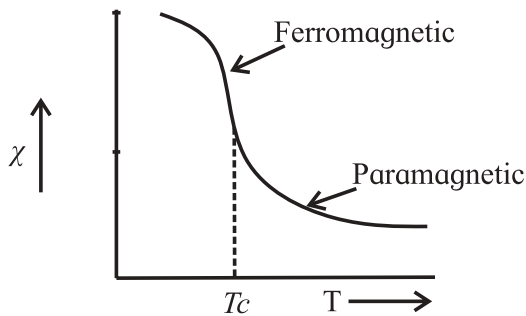

Fig. 11.10: Curie Temperature T_c of some Ferromagnetic material.

Table 11.1 Curie Temperature of some materials

Material	T_c (K)
Metallic cobalt	1394
Metallic iron	1043
Fe_2O_3	893
Metallic nickel	631
Metallic gadolinium	317

11.6 Hysteresis:

The behaviour of ferromagnetic material when placed in external magnetic field is quite interesting and informative. It is nonlinear and provides information of magnetic history of the sample. To understand this, let us consider an unmagnetized ferromagnetic material in the form of a rod placed inside a solenoid. On passing the current through solenoid, magnetic field is generated which magnetises the rod. Knowing the value of χ of the material of the rod, M (magnetization) can be easily calculated from $M = \chi H$. From Eq. (11.16),

$$H = \frac{B}{\mu_0} - M$$

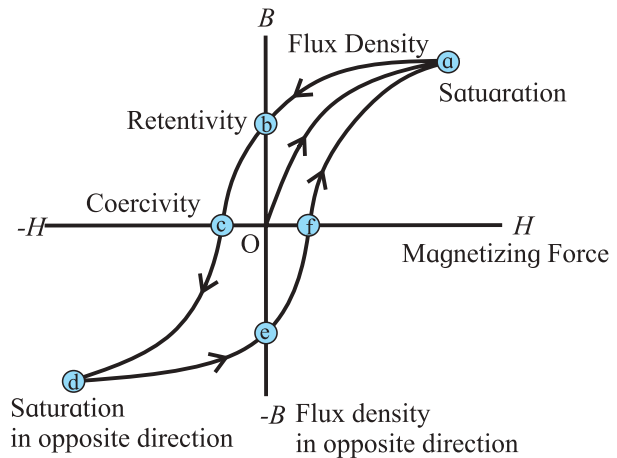

Fig. 11.11: Hysteresis cycle (loop).

Knowing the value of $H (= nI)$ and M , one can calculate the corresponding magnetic field B from the above equation. Figure 11.11 shows the behaviour of the material as we take it through one cycle of magnetisation. At point O in the graph the material is in nonmagnetised state. As the strength of external magnetic intensity H is increased, B also increases as shown by the dotted line. But the increase is non linear. Near point a , the magnetic field is at its maximum value which is the saturation magnetization condition of the rod. This represents the complete alignment and merger of domains. If H is increased further, (by increasing the current flowing through the solenoid) there is no increase in B .

This process is not reversible. At this stage if the current in the solenoid is reduced, the earlier path of the graph is not retraced. (Earlier domain structure is not recovered). When $H = 0$ (current through the solenoid is made zero, point b in the figure) we do not get $B = 0$. The value of B when $H = 0$ is called retentivity or remanence. This means some domain alignment is still retained even when $H = 0$. Next, when the current in the solenoid is increased in the reverse direction, point c in the graph is reached, where $B = 0$ at a certain value of H . This value of H is called coercivity. At this point the domain

axes are randomly oriented with respect to each other. If the current is further increased, in the reverse direction, B increases and again reaches a saturation state (point d). Here if H is increase further, B does not increase. From this point d onwards, when H is reduced, B also reduces along the path de. At this point e, again $H = 0$ but B is not zero. It means domain structure is present but the direction of magnetisation is reversed. Further increase in the current, gives the curve efa. On reaching point a, one loop is complete. This loop is called hysteresis loop and the process of taking magnetic material through the loop once is called hysteresis cycle.



Can you recall?

Do you recall a similar loop/effect?

It is similar to stress hysteresis you have studied in mechanical properties of solid in XIth Std. The stress strain curve for increasing and decreasing load was discussed. Area inside the loop gives the energy dissipated during deformation of the material.



Use your brain power

What does the area inside the curve $B - H$ (hysteresis curve) indicate?

11.7 Permanent Magnet and Electromagnet:

Soft iron having large permeability (>1000) and small amount of retaining magnetization, is used to make electromagnets. For this purpose, a soft iron rod (or that of a soft ferromagnetic material) is placed in a solenoid core. On passing current through the solenoid, the magnetic field associated with solenoid increases thousand folds. When the current through the solenoid is switched off, the associated magnetic field effectively becomes zero. These electromagnets are used in electric bells, loud speakers, circuit breakers, and also in research laboratories. Giant electromagnets are used in cranes to lift heavy loads made of iron. Superconducting magnets are used to prepare very high magnetic fields of the order of a few tesla. Such magnets are used in NMR

(Nuclear Magnetic Resonance) spectroscopy. Permanent magnets are prepared by using a hard ferromagnetic rod instead of soft used in earlier case. When the current is switched on, magnetic field of solenoid magnetises the rod. As the hard ferromagnetic material has a property to retain the magnetization to larger extent, the material remains magnetised even after switching off the current through the solenoid.



Do you know?

What is soft magnetic material?

Soft ferromagnetic materials can be easily magnetized and demagnetized.

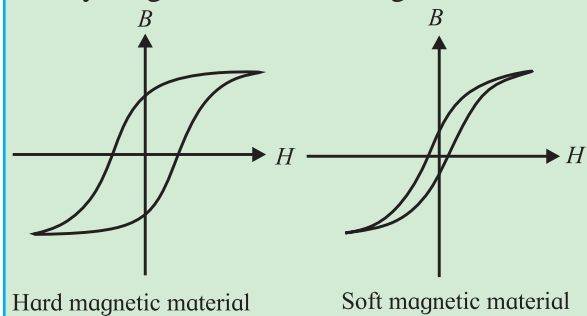

Hard magnetic material

Soft magnetic material

Hysteresis loop for hard and soft ferramagnetic materials.

11.8 Magnetic Shielding:

When a soft ferromagnetic material is kept in a uniform magnetic field, large number of magnetic lines crowd up inside the material leaving a few outside. If we have a closed structure of this material, say a spherical shell of iron kept in magnetic field, very few lines of force pass through the enclosed space. Most of the lines will be crowded into the iron shell (Fig. 11.12). This effect is known as magnetic shielding. The instrument which need to be protected from magnetic field is completely surrounded by a soft ferromagnetic substance. This technique is being used in space ships. Some scientific experiments require the experiment to be protected from magnetic field in the laboratory. There, high magnetic fields of magnets need to be shielded by providing a case made up of soft ferromagnetic material.

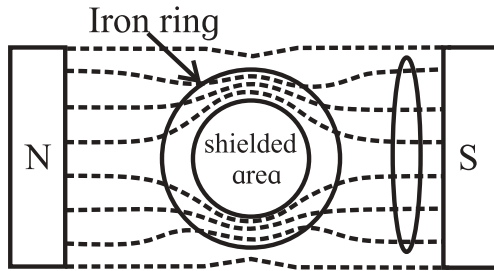

Fig. 11.12 Magnetic Shielding.

**Internet my friend**

1. <http://www.nde-ed.org>
2. <https://physics.info/magnetism/>

**Do you know?**

There are different types of shielding available like electrical and acoustic shielding apart from magnetic shielding discussed above. Electrical insulator functions as an electrical barrier or shield and comes in a wide array of materials. Normally the electrical wires used in our households are also shielded. In case of audio recording it is necessary to reduce other stray sound which may interfere with the sound to be recorded. So the recording studios are sound insulated using acoustic material.

**Exercises****1. Choose the correct option.**

- i) Intensity of magnetic field of the earth at the point inside a hollow iron box is.
 - (A) less than that outside
 - (B) more than that outside
 - (C) same as that outside
 - (D) zero
- ii) Soft iron is used to make the core of transformer because of its
 - (A) low coercivity and low retentivity
 - (B) low coercivity and high retentivity
 - (C) high coercivity and high retentivity
 - (D) high coercivity and low retentivity
- iii) Which of the following statements is correct for diamagnetic materials?
 - (A) $\mu_r < 1$
 - (B) χ is negative and low
 - (C) χ does not depend on temperature
 - (D) All of above
- iv) A rectangular magnet suspended freely has a period of oscillation equal to T . Now it is broken into two equal halves (each having half of the original length) and one piece is made to oscillate freely. Its period of oscillation is T' , the ratio of T' / T is.

(A) $\frac{1}{2\sqrt{2}}$	(B) $1/2$
(C) 2	(D) $1/4$

- v) A magnetising field of 360 Am^{-1} produces a magnetic flux density (B) = 0.6 T in a ferromagnetic material. What is its permeability in Tm A^{-1} ?

(A) $1/300$	(B) 300
(C) $1/600$	(D) 600

2 Answer in brief.

- i) Which property of soft iron makes it useful for preparing electromagnet?
- ii) What happens to a ferromagnetic material when its temperature increases above curie temperature?
- iii) What should be retentivity and coercivity of permanent magnet?
- iv) Discuss the Curie law for paramagnetic material.
- v) Obtain an expression for orbital magnetic moment of an electron rotating about the nucleus in an atom.
- vi) What does the hysteresis loop represents?
- vii) Explain one application of electromagnet.

3. When a plate of magnetic material of size $10 \text{ cm} \times 0.5 \text{ cm} \times 0.2 \text{ cm}$ (length, breadth and thickness respectively) is located in magnetising field of $0.5 \times 10^4 \text{ Am}^{-1}$ then a magnetic moment of 5 Am^2 is induced in it. Find out magnetic induction in rod.

[Ans: 0.634 Wb/m^2]

4. A rod of magnetic material of cross section 0.25 cm^2 is located in 4000 Am^{-1} magnetising field. Magnetic flux passing through the rod is $25 \times 10^{-6} \text{ Wb}$. Find out (a) relative permeability (b) magnetic susceptibility and (c) magnetisation of the rod
[Ans: 199, 198 and $7.92 \times 10^5 \text{ Am}^{-1}$]
5. The work done for rotating a magnet with magnetic dipole moment m , through 90° from its magnetic meridian is n times the work done to rotate it through 60° . Find the value of n .
[Ans: 2]
6. An electron in an atom is revolving round the nucleus in a circular orbit of radius $5.3 \times 10^{-11} \text{ m}$, with a speed of $2 \times 10^6 \text{ ms}^{-1}$. Find the resultant orbital magnetic moment and angular momentum of electron. (charge on electron $e = 1.6 \times 10^{-19} \text{ C}$, mass of electron $m = 9.1 \times 10^{-31} \text{ kg}$.)
[Ans: $8.48 \times 10^{-24} \text{ Am}^2$, $9.65 \times 10^{-35} \text{ N m s}$]
7. Aparamagnetic gas has 2.0×10^{26} atoms/m with atomic magnetic dipole moment of $1.5 \times 10^{-23} \text{ A m}^2$ each. The gas is at 27° C . (a) Find the maximum magnetization intensity of this sample. (b) If the gas in this problem is kept in a uniform magnetic field of 3 T , is it possible to achieve saturation magnetization? Why?
[Ans: $3.0 \times 10^3 \text{ A m}^{-1}$, No]
(Hint: Find the ratio of Thermal energy of atom of a gas ($3/2 k_B T$) and maximum potential energy of the atom (mB) and draw your conclusion)
8. A magnetic needle placed in uniform magnetic field has magnetic moment of $2 \times 10^{-2} \text{ A m}^2$, and moment of inertia of $7.2 \times 10^{-7} \text{ kg m}^2$. It performs 10 complete oscillations in 6 s. What is the magnitude of the magnetic field ?
[Ans: $39.48 \times 10^{-4} \text{ Wb/m}^2$]
9. A short bar magnet is placed in an external magnetic field of 700 gauss . When its axis makes an angle of 30° with the external magnetic field, it experiences a torque of 0.014 Nm . Find the magnetic moment of the magnet, and the work done in moving it from its most stable to most unstable position.
[Ans: 0.4 A m^2 , 0.048 J]
10. A magnetic needle is suspended freely so that it can rotate freely in the magnetic meridian. In order to keep it in the horizontal position, a weight of 0.2 g is kept on one end of the needle. If the pole strength of this needle is 20 Am , find the value of the vertical component of the earth's magnetic field. ($g = 9.8 \text{ m s}^{-2}$)
[Ans: $4.9 \times 10^{-5} \text{ T}$]
11. The susceptibility of a paramagnetic material is χ at 27° C . At what temperature its susceptibility be $\chi/3$?
[Ans: 627° C]

12. Electromagnetic Induction



Can you recall?

1. What is the force experienced by a moving charge in a magnetic field?
2. What is the torque experienced by a current carrying loop kept in a magnetic field?
3. What is the magnetic dipole moment of a current carrying coil?
4. What is the flux of a vector field through a given area?

12.1 Introduction:

So far, we have focussed our attention on the generation of electric fields by stationary charges and magnetic fields by moving charges. During the early decades of nineteenth century, Oersted, Ampere and a few others established the fact that electricity and magnetism are inter-related. A question was then naturally raised whether the converse effect of – the moving electric charges produce magnetic fields – was possible? That is, can we produce electric current by moving magnets?

In 1831, Faraday in England performed a series of experiments in connection with the generation of electric current by means of magnetic flux. In the same year Joseph Henry (1799-1878) demonstrated that electric currents were indeed produced in closed circuits or coils when subjected to time-varying magnetic fields. The outcome of these experiments led to a very basic and important law of electromagnetism known as Faraday's law of induction. An electromotive force (emf) and, therefore, a current can be induced in various processes that involve a change in magnetic flux. The experimental observations of Faraday are summarized as given below:

- i) When a magnet approaches a closed circuit consisting of a coil (Fig. 12.1), it produces a current in it. This current is known as induced current.

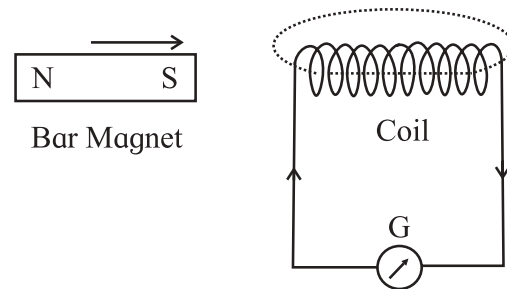

Fig. 12.1: A bar magnet approaching a closed circuit consisting of a coil and galvanometer (G).

- ii) When the magnet is taken away from the closed circuit a current is again produced but in the opposite direction with respect to that in experiment (i).
- iii) If instead of the magnet, the coil is moved towards the magnet or away from it, an induced current is produced in the coil (i.e., in the closed circuit).
- iv) If the polarity of approaching or receding magnet is changed the direction of induced current in the coil is also changed.
- v) The magnitude of induced current depends on the relative speed of the coil with respect to magnet. It also depends upon the number of turns in the coil.
- vi) The induced current exists so long as there is a relative motion between the coil and magnet.

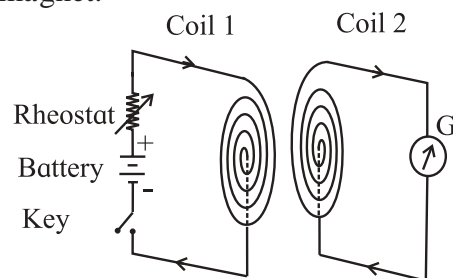

Fig. 12.2: Two coils with their planes facing each other.

- vii) Instead of a magnet and a closed circuit, two coils with their planes facing each other (Fig. 12.2) also produce similar effects as mentioned above in experiments from (i) to (vi). One coil is connected

in series with a battery, rheostat and key while the ends of the other coil are connected to a galvanometer (G). The coil which consists of a source of emf (a battery) is termed as primary coil while the other as secondary coil. With these two coils, following observations are made:

- (i) When the circuit in the primary coil is closed or broken, a momentary deflection is produced in the galvanometer at the time of make or break. When the circuit is closed or broken the directions of deflection in the galvanometer are opposite to each other.
- (ii) When there is a relative motion between the two coils (with their circuits closed), an induced current is produced in the secondary coil but it exists so long as there is a relative motion between the coils.
- (iii) Whenever the current in the primary coil is changed (either increased or decreased) by sliding the rheostat-jockey, a deflection is produced in the galvanometer. This indicates the presence of induced current. The induced current exists so long as there is a change of current in the primary coil. The above observations indicate that so long as there is a change of magnetic flux (produced either by means of a magnet or by a current carrying coil) inside a coil, an induced emf is produced. The direction of induced emf reverses if instead of increasing the flux, the flux is decreased or vice versa.

12.2 Faraday's Laws of Electromagnetic Induction:

On the basis of experimental evidences, Faraday enunciated following laws concerning electromagnetic induction.

First law: Whenever there is a change of magnetic flux in a closed circuit, an induced emf is produced in the circuit.

This law is a qualitative law as it only indicates the characteristics of induced emf.

Second law: The magnitude of induced emf produced in the circuit is directly proportional to the rate of change of magnetic flux linked with the circuit. This law is known as quantitative law as it gives the magnitude of induced emf.

If ϕ is the magnetic flux linked with the coil at any instant t , then the induced emf.

$$e \propto \frac{d\phi}{dt} \quad \text{--- (12.1)}$$

$$e = K \frac{d\phi}{dt}, K \text{ is constant of proportionality.}$$

If e , ϕ , and t are measured in the same system of units, $K = 1$.

$$\therefore e = \frac{d\phi}{dt} \quad \text{--- (12.2)}$$

If we combine this expression with the first law, we get

$$e = -\frac{d\phi}{dt} \quad \text{--- (12.3)}$$

If ϕ' is the flux associated with single turn, then the total magnetic flux ϕ for a coil consisting of n turns, is

$$\phi = n \phi' \\ \therefore e = -n \frac{d\phi'}{dt} \quad \text{--- (12.4)}$$

This is also known as 'flux rule' according to which the emf is equal to the rate at which the magnetic flux through a conducting circuit is changing.

In SI units e is measured in volt and $\frac{d\phi}{dt}$ is measured in weber/s.

We have already learnt while studying the magnetic effect of current that the charges in motion (or current) can exert force/torque on a stationary magnet (compass needle). Now we have observed in Faraday's experiments that a bar magnet in motion (or a time-varying magnetic field) can exert a force on the stationary charges inside the conductor and causes an induced emf across the ends of the conductor (open circuit)/or generates induced current in a closed circuit.

12.3 Lenz's Law:

H.F.E. Lenz (1804-1864) without knowledge of the work of Michael Faraday and Joseph Henry duplicated many of their discoveries independently almost at the same time.

For determining the direction of an induced current in a loop, Lenz devised a rule, which goes by his name as Lenz's Law. According to this rule, the direction of induced current in a circuit is such that the magnetic field produced by the induced current opposes the change in the magnetic flux that induces the current. The direction of induced emf is same as that of induced current. In short, the induced emf tends to set up a current the action of which opposes the change that causes it.

Applications of Lenz's law:

12.3.1 Motion of a Magnet Toward a Loop:

In order to get a feel for Lenz's law, let us consider a north pole of a magnet moving toward a conducting loop as shown in the Fig. 12.3.

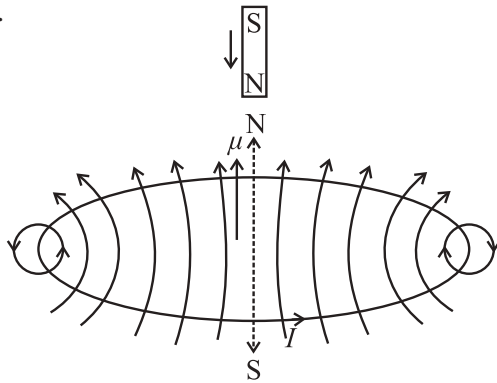

Fig. 12.3: Magnet's motion creates a magnetic dipole in the coil.

As the magnet is moved toward the loop, a current is induced in the loop. The induced current in the loop produces a magnetic dipole. The dipole is oriented in such a way that it opposes the motion of the magnet. Thus the loop's north pole must face the approaching north pole of the magnet so as to repel it. The curled right-hand (RH) rule for magnetic dipole or magnetic field will provide the direction of induced current in the loop. The induced current in the loop will be in counter

clockwise direction as shown in Fig. 12.3.

If the magnet is pulled away from the loop, a current will again be induced in the loop in such a way that the loop will have a south pole facing the retreating north pole and will oppose the retreat by attracting it. The induced current in the loop will now flow in clockwise direction.

Jumping Ring Experiment: A coil is wound around an iron core which is held vertically upright. A metallic ring is placed on top of the iron core. A current is then switched on to pass through the coil. This will make the ring jump several meters in air.

Explanation: Before the current in the coil is turned on, the magnetic flux through the ring is zero. Afterwards, the flux appears in the coil in upward direction. This change in flux causes an induced emf and induced current as well in the ring. The direction of induced current in the ring will be opposite to the direction of current in the coil, as dictated by Lenz's law. As the opposite currents repel, the ring flies off in air.

12.3.2 Energy Conservation in Lenz's Law:

We have learnt that the cause of the induced current may be either (i) the motion of a conductor (wire) in a magnetic field or (ii) the change of magnetic flux through a stationary circuit.

In the first case, the direction of induced current in the moving conductor (wire) is such that the direction of the thrust exerted on the conductor (wire) by the magnetic field is opposite to the direction of its motion and thus opposes the motion of the conductor.

In the second case, the current sets up a magnetic field of its own which within the area bounded by the circuit is

- opposite to the original magnetic field if this field is increasing; but
- in the same direction as the original field, if the field is decreasing.

Thus it is the 'change in flux' through the circuit (not the flux itself), which is opposed by the induced current.

Lenz's law follows directly from the conservation of energy. If an induced current flows in a circuit in such a direction that it helps the cause that produces it, then we will soon find that the induced current and the magnetic flux penetrating the loop would lead to an infinite growth. The induced current once started flowing in the loop would keep increasing indefinitely producing joule heating at no extra cost and thus be self-sustaining (perpetual motion machine). This will violate the law of conservation of energy. We thus see that Lenz's law is a necessary consequence of the law of conservation of energy.

The opposing sense of the induced current is one manifestation of a general statement of Lenz's law: "Every effect of induction acts in opposition to the cause that produces it"

In order to have an induced current, we must have a closed circuit. If a conductor is not forming a closed circuit we mentally construct a circuit between the two ends of the conductor/wire and use Lenz's law to determine the direction of induced current. Then the polarity of the ends of the open-circuited conductor can be found easily.

12.3.3 Lenz's Law and Faraday's Law:

Consider Faraday's law with special attention to the negative (-ve) sign.

$$e = -\frac{d\phi}{dt}$$

Consider that area vector \vec{A} of the loop perpendicular to the plane of the loop is fixed and oriented parallel ($\theta = 0$) to magnetic field \vec{B} . The magnetic field \vec{B} increases with time.

Using the definition of flux, the Faraday's law can be written as

$$e = -\frac{d}{dt}(\vec{B} \cdot \vec{A}) = -|\vec{A}| \frac{d|\vec{B}|}{dt} \quad \text{--- (12.5)}$$

\therefore RHS = -ve quantity as $|\vec{A}|$ is positive and $\frac{dB}{dt}$ is positive (+ve) as B is increasing with time.

The screw driver rule fixes the positive sense of circulation around the loop as the clockwise direction.

As the sense of the induced current in the loop is counter clockwise (negative), the sense of induced emf also is negative (-ve). That is, the LHS of Eq. (12.5) is indeed a negative (-ve) quantity in order to be equal to the RHS.

Thus the negative (-ve) sign in the equation $e = -\frac{d\phi}{dt}$ incorporates Lenz's law into Faraday's law.

12.4 Flux of the Field:

The concept of flux of the magnetic field is vital to our understanding of Faraday's law.

As shown in Fig. 12.4 (a), consider a small element of area \vec{da} . A direction is assigned to this element of area such that if the curve bounding the area is traversed in the direction of the arrow then the normal comes out of the plane of paper towards the reader. In other words it is the direction in which right handed screw will move if rotated in the sense of the arrow on the curve.

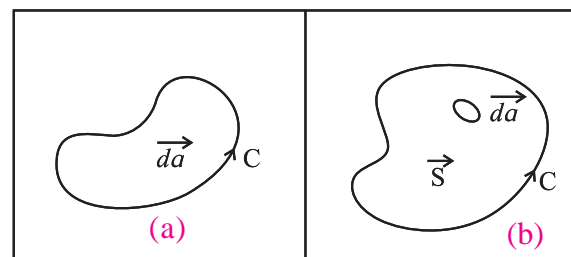

Fig. 12.4: (a) Small element of area \vec{da} bounded by a curve considered in anticlockwise direction. (Right-handed screw Rule), (b) Finite surface area \vec{S} .

Suppose the element of area \vec{da} is situated in a magnetic field \vec{B} . Then the scalar quantity $d\phi = \vec{B} \cdot \vec{da} = |\vec{B}| \cdot |\vec{da}| \cos\theta$ --- (12.6) is called the flux of \vec{B} through the area \vec{da} where θ is the angle between the direction of magnetic field \vec{B} and the direction assigned to the area \vec{da} .

This can be generalised to define the flux over a finite area \vec{S} . It should be remembered that the magnetic field \vec{B} will not be the

same at different points within the finite area. Therefore the area is divided into small sections of area \vec{da} so as to calculate the flux over each section and then to integrate over the entire area (Fig. 12.3 (b))

Thus, the flux passing through S is

$$\phi = \int_S \vec{B} \cdot \vec{da} \quad \text{--- (12.7)}$$

We can not take \vec{B} out of the integral in Eq. (12.6) unless \vec{B} is the same everywhere in \vec{S} .

If the magnetic field at every point changes with time as well, then the flux ϕ will also change with time.

$$\phi = \phi(t) = \int_S \vec{B}(t) \cdot \vec{da} \quad \text{--- (12.8)}$$

Faraday's discovery was that the rate of change of flux $\left(\frac{d\phi}{dt}\right)$ is related to the work done to take a unit positive charge around the contour C [Fig. 12.4 (b)] in the 'reverse' direction. This work done is just the emf.

Accordingly, Faraday's law states that the induced emf can be written as

$$e = -\frac{d\phi}{dt} = -\frac{d}{dt} \int_S \vec{B}(t) \cdot \vec{da} \quad \text{--- (12.9)}$$

In S.I. units the emf, e will be in volt, the flux ϕ in weber and time t in second.

From Eq. (12.9) we can see that even if \vec{B} does not change with time, flux may still vary if the area S changes with time.

12.5 Motional Electromotive Force:

a) Translational motion of a conductor:

As shown in Fig. 12.5, a rectangular frame of wires ABCD of area ($l x$) is situated in a constant magnetic field (\vec{B}). As the wire BC of length l is moved out with velocity \vec{v} to increase x the area of the loop ABCD increases. Thus the flux of \vec{B} through the loop increases with time. According to the 'Flux Rule' the induced emf will be equal to the rate at which the magnetic flux through a conducting circuit is changing as stated in Eq. (12.9). The induced emf will cause a current in the loop. It is assumed that there is enough

resistance in the wire so that the induced currents are very small producing negligible magnetic field.

As the flux ϕ through the frame ABCD is Blx , magnitude of the induced emf can be written as

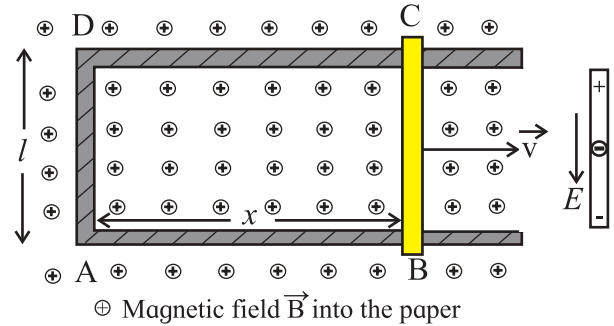

Fig. 12.5: A frame of wire ABCD in magnetic field \vec{B} . Wire BC is moving with velocity \vec{v} along x-axis.

$$|e| = \frac{d\phi}{dt} = \frac{d}{dt}(Blx) = Bl \frac{dx}{dt} = Blv, \text{--- (12.10)}$$

where v is the velocity of wire BC increasing the length x of wires AB and CD.

Now we can understand the above result from the magnetic forces on the charges in the moving wire BC.

A charge q which is carried along by the moving wire BC, experiences Lorentz force $\vec{F} = q(\vec{v} \times \vec{B})$; which is perpendicular to both \vec{v} and \vec{B} and hence is parallel to wire BC. The force \vec{F} is constant along the length l of the wire BC (as v and B are constant) and zero elsewhere ($\because v = 0$ for stationary part CDAB of wire frame). When the charge q moves a distance l along the wire, the work done by the Lorentz force is $W = F \cdot l = qvB \sin \theta \cdot l$, where θ is the angle between \vec{B} and \vec{v} . The emf generated is work/ charge i.e.,

$$e = \frac{W}{q} = vB \sin \theta \cdot l \quad \text{--- (12.11)}$$

For maximum induced emf, $\sin \theta = 1$

$$e_{\text{max}} = Blv \quad \text{--- (12.12)}$$

which is the same result as obtained in Eq. (12.10) derived from the rate of change of flux.

In general, it can be proved that for any circuit whose parts move in a fixed magnetic field, the induced emf is the time derivative of flux (ϕ) regardless of the shape of the circuit.

The flux rule is also applicable in case of a wire loop that is kept stationary and the magnetic field is changed. The Lorentz force on the electrical charges is given by $\vec{F} = q (\vec{E} + \vec{v} \times \vec{B})$. There are no new special forces due to changing magnetic fields. Any force on charges at rest in a stationary wire comes from the \vec{E} -term. Faraday's observations led to the discovery that electric and magnetic fields are related by a new law: *In a region where magnetic field is changing with time, electric fields are generated.* It is this electric field which drives the electrons around the conductor circuit and as such is responsible for the induced emf in a stationary circuit whenever there is a changing magnetic flux.

The flux rule holds good so long as the change in the magnetic flux is due to the changes in magnetic field or due to the motion of the circuit or both.

b) Motional emf in a rotating bar:

A rotating bar is different in nature from the sliding bar. As shown in Fig. 12.6, consider a small segment dr of the bar at a distance r from the pivot. It is a short length dr of the conductor which is moving with velocity \vec{v} in magnetic field \vec{B} and has an induced emf generated in it like a sliding bar.

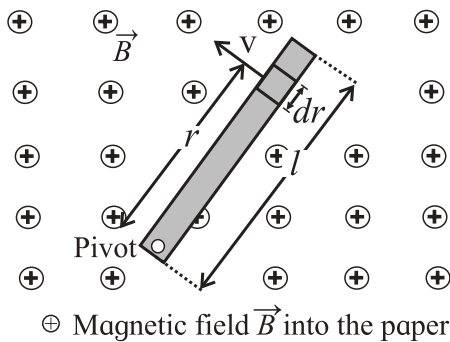

Fig. 12.6: A conducting bar rotating around a pivot at one end in a uniform magnetic field that is perpendicular to the plane of rotation. A rotational emf is induced between the ends of the bar.

By imagining all such segments as a source of emf, we can find that all these segments are in series and, therefore, the emfs of individual segments will be added.

Now we know that the induced emf de in the small segment dr of the rotating conductor.

$$de = B v dr$$

Total induced emf in rotating rod

$$e = \int de = \int Bvdr$$

$$e = \int B\omega r dr = B\omega \int_0^l r dr$$

$$= B\omega \frac{l^2}{2}$$

$$e = \frac{1}{2} B\omega l^2 \quad \text{--- (12.13)}$$

Compare the above result with the induced emf in sliding bar, $e = Blv$.

12.6 Induced emf in a Stationary Coil in a Changing Magnetic Field:

As shown in Fig. 12.7 (a) in a magnet-coil system, a permanent bar magnet is mounted on an arc of a semicircle of radius 50 cm. The arc is a part of a rigid frame of aluminium and is suspended at the centre of arc so that whole system can oscillate freely in its plane. A coil of about 10,000 turns of copper wire loop the arc so that the bar magnet can pass through the coil freely.

When the magnet moves through the coil, the magnetic flux through the coil changes.

In order to measure the induced emf, a capacitor (C) and diode (D) are connected across the coil (Fig. 12.7 (b)) The induced emf produced in the coil is used for charging a capacitor through a diode. Then the voltage developed across the capacitor is measured. The capacitor may not get charged upto the peak value in a single swing as the time-constant (RC) may be larger than the time during which the emf in the coil is generated. This may take about a few oscillations to charge the capacitor to the peak value and is indicated by the ammeter (mA) which will tell us when the charging current ceases to flow.

As the magnet, kept in the middle of the arc (Fig. 12.7 (a)), starts far away from the coil moves through it and recedes, the magnetic field /flux through the coil changes from a small value, increases to its maximum and becomes small again thus inducing an emf. Actually, there is substantial magnetic field at the coil only when it is very near the magnet. The speed of the magnet is largest when it approaches the coil (placed at the mean position of the oscillation). Thus the magnetic field changes quite slowly with time when the magnet is far away and changes rapidly when it approaches the coil. The variation of magnetic field \vec{B} (at the coil in mean position) with time is shown in Fig. 12.7 (c).

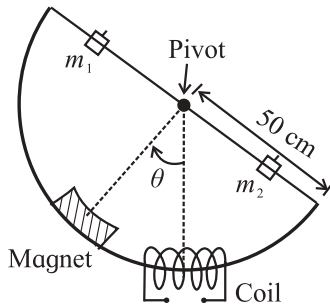

Fig. 12.7 (a): Magnet-coil system.

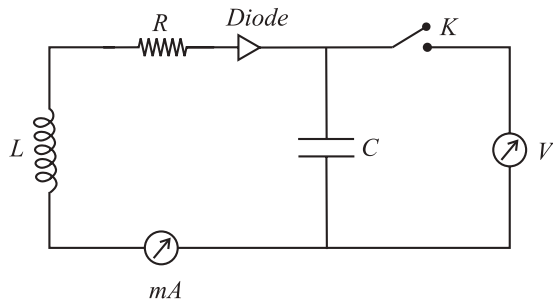

Fig. 12.7 (b): Measurement of induced emf.

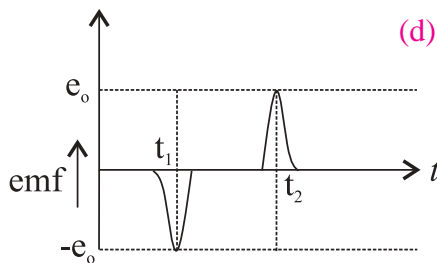
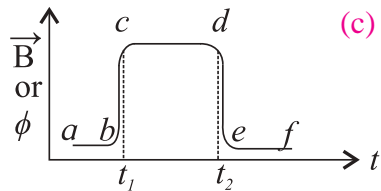

Fig. 12.7: (c) Variation of \vec{B} with time t , (d) variation of e with time t .

The centre of the hump 'bcde' refers to the time when the magnet is inside the coil. The flat portion (cd) at the top corresponds to the finite length of the magnet. The magnetic flux (ϕ) is related to magnetic field (B) through a constant (effective area = No. of turns \times area of coil).

Now, the induced emf is proportional to $d\phi/dt$, that is to the slope of the curve in Fig. 12.7 (c). As the slope of the curve is largest at times t_1 and t_2 , the magnitude of induced emf will be largest at these times. But Lenz's law gives minus sign (-) in Eq. 12.3

$(e = -\frac{d\phi}{dt})$, which means that emf (e) is 'negative' when ϕ is increasing at t_1 and 'positive' when ϕ is decreasing at time t_2 . This is shown in Fig. 12.7 (d) relating induced emf (e) with time (t).

Remember the sequence of two pulses; one 'negative' and one 'positive' occurs during just half a cycle of motion of the magnet. On the return swing of the magnet, they will be repeated (which one will be repeated first, the 'negative' or 'positive' pulse?).

Now we consider the effect of these pulses on the charging circuit (Fig. 12.7 (b)) The diode will conduct only during the 'positive' pulse. At the first half swing, the capacitor will charge up to a potential, say e_1 . During the next half swing, the diode will be cut off until 'positive' pulse is produced and then the capacitor will charge up to a slightly higher potential, say e_2 . This will continue for a few oscillations till the capacitor charges up to its peak value e_0 by the voltage/ emf pulse. At this stage ammeter will show no kick (further increase) in the current of the circuit.

In order to have an estimate of e_0 , the equation for induced emf can be written as

$$|e| = \left| \frac{d\phi}{dt} \right| = \left| \frac{d\phi}{d\theta} \right| \cdot \left| \frac{d\theta}{dt} \right| \quad \text{--- (12.14)}$$

The first term depends on the geometry of the magnet and the coil. At $\theta = 0$, the mean position, we have maximum ϕ . But we are

interested in $\left(\frac{d\phi}{d\theta}\right)$, which is actually zero at $\theta = 0$. The second term $\frac{d\theta}{dt}$ can be deduced from the oscillation equation.

$\theta = \theta_0 \sin 2\pi\nu t$, θ_0 being the amplitude of oscillating magnet.

$$\therefore \text{frequency } (\nu) = \frac{1}{\text{time period } (T)}$$

$$\theta = \theta_0 \sin \frac{2\pi}{T} t$$

$$\therefore \frac{d\theta}{dt} = \theta_0 \cos \frac{2\pi}{T} t \cdot \left(\frac{2\pi}{T}\right)$$

$$\frac{d\theta}{dt} = \frac{2\pi\theta_0}{T} \cos \frac{2\pi t}{T} \quad \text{--- (12.15)}$$

The peak voltage (emf) e_0 in the induced emf pulse corresponds to $\left(\frac{d\phi}{dt}\right)_{\text{max}}$.

We can see from Fig. 12.7 (c) that $\left(\frac{d\phi}{d\theta}\right)_{\text{max}}$ occurs at positions near the mean position. In Eq. 12.15, the cosine term does not differ much from unity for very small angles (close to zero).

Hence we conclude that

$$|e_0| = \left(\frac{d\phi}{dt}\right)_{\text{max}} \approx \left(\frac{d\phi}{d\theta}\right)_{\text{max}} \cdot \left(\frac{2\pi\theta_0}{T}\right) \text{--- (12.16)}$$

For given magnet-coil system, the peak induced emf e_0 is directly proportional to angular amplitude (θ_0) and inversely proportional to time period (T).

Example 12.1: A coil consists of 400 turns of wire. Each turn is a square of side $d = 20$ cm. A uniform magnetic field directed perpendicular to the plane of the coil is turned on. If the field changes linearly from 0 to 0.50 T in 0.8 s, what is the magnitude of induced emf in the coil while the field is changing?

Solution: The magnitude of induced emf in the coil is written as

$$|e| = |d(N\phi) / dt| = N (d\phi / dt)$$

$$\therefore \phi = B \cdot A$$

$$\therefore |e| = N \cdot d(BA) / dt$$

$= N \cdot A \cdot (dB / dt)$ (as A is constant and B is changing with time)

$$= N \cdot A \cdot (\Delta B / \Delta t) = N \cdot A \cdot (B_{\text{final}} - B_{\text{initial}} / \Delta t)$$

Inserting the given values of $N = 400$, $A = (20 \text{ cm})^2 = (0.2 \text{ m})^2$, $B_{\text{final}} = 0.5 \text{ T}$, $B_{\text{initial}} = 0$, $\Delta t = 0.8 \text{ s}$

we find the induced emf

$$|e| = 400 \cdot (0.20 \text{ m})^2 (0.5 \text{ T}) / 0.8 \text{ s} = 10 \text{ Volt}$$

Example 12.2 : A long solenoid s , as shown in the figure has 200 turns/cm and carries a current i of 1.4 A. The diameter D of the solenoid is 3 cm. A coil C , having 100 turns and a diameter d of 2 cm is kept at the centre of the solenoid. The current in the solenoid is decreased steadily to zero in 20 ms. Calculate the magnitude of emf induced in the coil C when the current in the solenoid is changing.

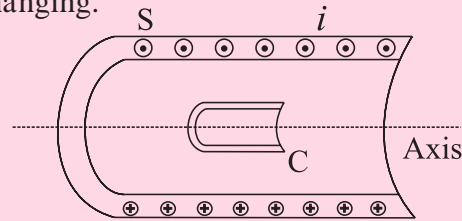

- ⊙ Magnetic field \vec{B} out of paper
- ⊕ Magnetic field \vec{B} into the paper

Solution: Given, diameter $D = 3 \text{ cm} = 0.03 \text{ m}$
Cross section Area of solenoid =

$$A = \frac{\pi D^2}{4} = \frac{3.14 \times 3 \times 3}{4} \text{ cm}^2 = \frac{28.26}{4} \text{ cm}^2$$

$$A = 7.065 \text{ cm}^2$$

$$A = 7.065 \times 10^{-4} \text{ m}^2$$

Number of turns in unit length,

$$n = 200/\text{cm} = \frac{200 \times 100}{\text{m}} = 2 \times 10^4 \text{ turns/m}$$

The magnetic flux of the solenoid due to current i can be written as

$$\phi_{Bi} = B \cdot A = (\mu_0 ni) \cdot A$$

$$= (4\pi \times 10^{-7} \text{ T.m / A}) \cdot (2 \times 10^4 \text{ turns/ m}) \cdot (1.4 \text{ A}) \cdot (7.065 \times 10^{-4} \text{ m}^2)$$

$$\phi_{Bi} = 4\pi \times 2 \times 1.40 \times 7.065 \times 10^{-7} \text{ T.m}^2$$

$$= 2.485 \times 10^{-5} \text{ Wb}$$

Now,

$$\frac{d\phi_B}{dt} = \frac{\Delta\phi_B}{\Delta t} = \frac{(\phi_{B,f} - \phi_{B,i})}{(20 \times 10^{-3}) \text{ s}}$$

$$= \frac{0 - 2.485 \times 10^{-5} \text{ Wb}}{20 \times 10^{-3} \text{ s}}$$

$$= -1.243 \times 10^{-3} \text{ Wb / sec}$$

$$= -1.243 \times 10^{-3} \text{ V}$$

$$\therefore \left| \frac{d\phi_B}{dt} \right| = 1.243 \times 10^{-3} \text{ V}$$

Now the induced emf in the coil C with $N = 100$ turns can be written as

$$e = N \left| \frac{d\phi_B}{dt} \right| = 100 \cdot 1.243 \times 10^{-3} \text{ V}$$

$$= 1.243 \times 10^{-1} \text{ V}$$

$$= 124.3 \times 10^{-3} \text{ V}$$

$$e = 124.3 \text{ mV}$$

12.7 Generators:

In Chapter 10 you have learnt the principle of electric motors. The basic construction of an electric generator is the same as that of a motor. In this case the armature is turned by some external agency/torque as shown in

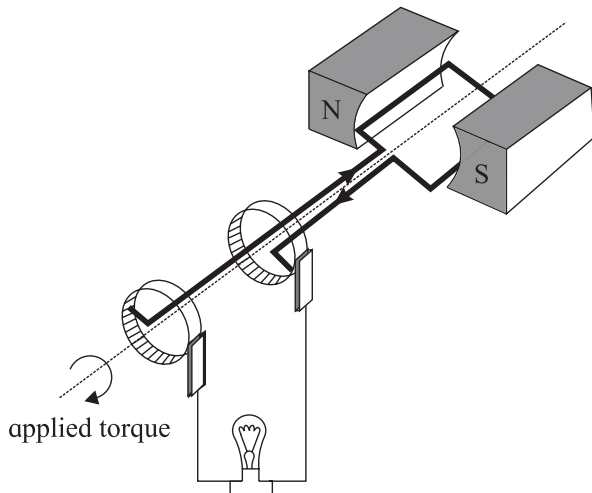

Fig. 12.8 (a): Schematic of a Generator.

Fig.12.8 (a). As the conductor wires cut across the magnetic lines of force, an induced emf ($e = Blv$) is produced across the terminals of the commutator. The induced e.m.f is found to be proportional to the speed of rotation (ω) of the armature.

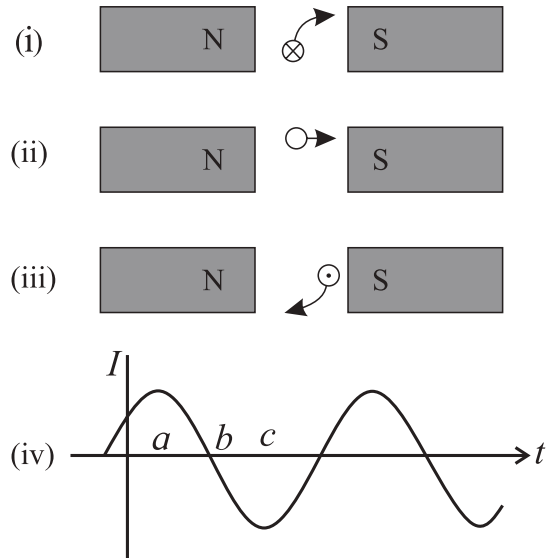

Fig. 12.8 (b): Wave form generation.

Let us focus our attention on one conductor of the armature as shown in Fig. 12.8 (b). In position (i), the conductor is moving upward across the lines of force inducing maximum emf. When the armature reaches in position (ii) the conductor is moving parallel to the field and there is no induced emf ($e = 0$). At position (iii), the same conductor moves down across the lines of force and the induced emf/ current is directed opposite to that in case of (i). The graph, plotted between the current flowing in the lamp as a function of the time (t) shows a sinusoidally varying current as is shown in (iv) of Fig. 12.8 (b).

When a coil is rotating with a constant angular velocity ω , the angle between magnetic field \vec{B} and the area vector \vec{A} of the coil at any instant t is $\theta = \omega t$ (assuming $\theta = 0$ at $t = 0$). As the effective area of the coil is changing due to rotation in the magnetic field B , the flux ϕ_B at any time can be written as

$$\phi_B = B \cdot A \cos \theta = B \cdot A \cos \omega t.$$

From Faraday's law, the induced emf e , generated by a rotating coil of N turns

$$e = -\frac{Nd\phi_B}{dt}$$

$$= -N \cdot \frac{d}{dt}(BA \cos \omega t)$$

$$= NBA\omega \sin \omega t$$

For $\sin \omega t = \pm 1$

$$e = \pm NBA\omega = \pm e_0$$

$$\therefore e = e_0 \sin \omega t$$

$$e = e_0 \sin 2\pi ft, \quad \text{--- (12.17)}$$

where f is the frequency of revolution of the coil.

Since the value of $\sin \omega t$ varies between +1 and -1, the polarity of the emf changes with time. The emf has its extremum value at $\theta = 90^\circ$ and 270° as the change in flux is greatest at these points. As the direction of induced current changes periodically it is called as alternating current (AC) (Fig. 12.8 (c)). The frequency of AC is equal to the number of times per second, the current changes from positive (+ve) to negative (-ve) and back again. The domestic electrical current varies at a frequency of 50 cycles/second.

For the purpose of charging a storage

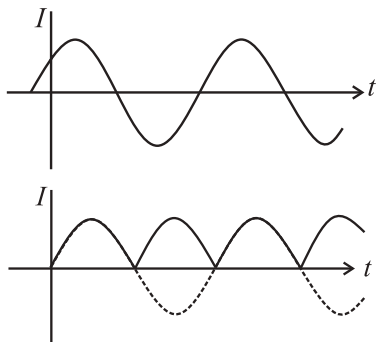
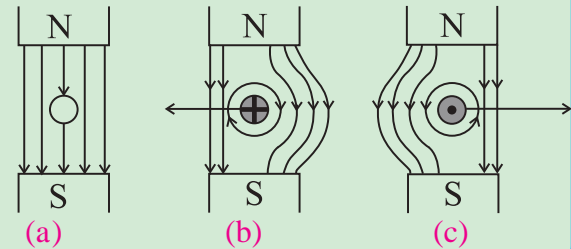

Fig. 12.8: (c) Alternating current, (d) Pulsating direct current.

battery it is necessary to generate a steady or direct current (DC). The reversing action of commutator can be used to generate pulsating DC as depicted in Fig. 12.8 (d). The commutator acts like a rapid switch which reverses the connections to the armature at just the right times to match with the reversals in current. Modern AC motors are more compact and rugged than the DC motors.

Do you know?

If a wire without any current is kept in a magnetic field, then it experiences no force as shown in figure (a). But when the wire is carrying a current into the plane of the paper in the magnetic field, a force will be exerted on the wire towards the left as shown in the figure (b). The field will be strengthened on the right side of the wire where the lines of force are in the same direction as that of the magnetic field and weakened on the left side where the field lines are in opposite direction to that of the applied magnetic field. For a wire carrying a current out of the plane of the paper, the force will act to the right as shown in figure (c).



12.8 Back emf and back torque:

We know that emf can be generated in a circuit in different ways. In a battery it is the chemical force, which gives rise to emf. In piezoelectric crystals mechanical pressure generates the emf. In a thermocouple it is the temperature gradient which is responsible for producing emf in a circuit containing the junctions of two metallic wires. In a photo electric cell, the incident light above a certain frequency is responsible for producing the emf. In a Van de Graaff Generator the electrons are literally loaded into a conveyor belt and swept along to create a potential difference. A generator utilises the movement of wire through a magnetic field to produce motional emf/current through a circuit. We have seen that the physical construction of a DC generator and motor is practically the same. If a DC generator is connected to a battery, it will run as a motor. If a motor is turned

by any external means, it will behave as a generator. So whenever a motor is running, its generator action can not be turned off. By Lenz's law the induced emf will tend to oppose the change which causes it. In the present case, the 'cause' is the current through the armature. Therefore, the induced emf will tend to reduce the armature current. The induced emf which is unavoidable due to generator action in a motor is called back emf. Initially, when a motor is just starting up, its armature is not turning and hence it is not producing any back emf. As the motor starts speeding up the back emf increases and armature current decreases. This explains the reason as to why the current through a motor is larger in the beginning than when the motor is running at full speed.

Example 12.3: A rotating armature of a simple generator consists of a loop ABCD to which connections are made through sliding contacts. The armature is rotated at 1500 rpm in the magnetic field (\vec{B}) of 0.5 N/A.m. Determine the induced emf between the terminals P and Q of the generator at the instant shown in the adjoining figure.

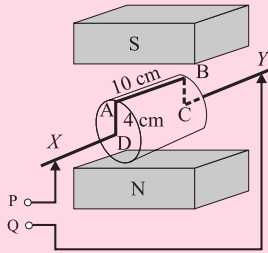

instant shown in the adjoining figure.

Solution: The wire AB ($l = 10$ cm) is moving to the right with the tangential velocity v .

$$|\vec{v}| = |\vec{\omega} \times \vec{r}|$$

$v = \omega r$ where ω is angular velocity and r is the radius.

$$\begin{aligned} v &= \frac{2\pi}{T} \cdot r \quad \left[\because \omega = \frac{2\pi}{T} \right] \\ &= 2\pi v r \\ &= 2\pi \cdot \left(\frac{1500}{60 \text{ s}} \right) \cdot \left(\frac{4}{100} \right) \text{ m} \quad \left[\because r = AD \right. \\ &\quad \left. = (4/100) \text{ m} \right] \\ &= 2\pi \text{ m/s} \\ &= 6.28 \text{ m/s} \end{aligned}$$

The magnetic field is directed vertically upward from North to South pole. As the

wire AB is cutting the magnetic lines of force perpendicularly, the induced emf is, therefore, maximum.

$$\therefore e = Blv \sin\theta \text{ with } \theta = 90^\circ,$$

$$\begin{aligned} \text{Then, } e &= e_{\text{max}} = Blv \\ &= (0.5 \text{ N/A.m}) (10/100) \text{ m} \cdot (6.28 \text{ m/s}) \\ &= \frac{0.5}{10} \times 6.28 \\ &= 0.314 \text{ V} \end{aligned}$$

$$\text{or } e_{\text{max}} \approx 314 \text{ mV.}$$

The emf induced in the wires BC and DA is zero because the magnetic Lorentz force on free electrons in these wire $[\vec{F} = q(\vec{v} \times \vec{B})]$ has no component parallel to the wires. Also there is no e.m.f. in the lead in wires, which are stationary and are not in motion ($\vec{v} = 0$). Therefore the total emf between the terminals P and Q is due the movement of segment AB. i.e., $e = 314$ mV. The direction of induced emf is given by Lenz's law.

Example 12.4: A conducting loop of area 1 m^2 is placed normal to uniform magnetic field 3 Wb/m^2 . If the magnetic field is uniformly reduced to 1 Wb/m^2 in a time of 0.5 s, calculate the induced emf produced in the loop.

Solution: Given,

$$\text{Area of the loop, } A = 1 \text{ m}^2$$

$$(B)_{\text{initial}} = 3 \text{ Wb/m}^2$$

$$(B)_{\text{final}} = 1 \text{ Wb/m}^2$$

$$\text{duration of time, } \Delta t = 0.5 \text{ s}$$

\therefore Induced emf,

$$\begin{aligned} |e| &= \left| \frac{d\phi}{dt} \right| = \left| \frac{\phi_{\text{final}} - \phi_{\text{initial}}}{\text{Time interval}} \right| \\ &= \frac{(B_{\text{final}} - B_{\text{initial}}) A}{\Delta t} \\ &= \left[\frac{(1-3)}{0.5} \cdot 1 \right] \text{ volt} \\ &= \left| -\frac{2}{0.5} \cdot 1 \right| \text{ volt} \\ |e| &= 4 \text{ volt} \end{aligned}$$

12.9 Induction and Energy Transfer:

Consider a loop ABCD moving with constant velocity \vec{v} in a constant magnetic field B as shown in Fig. 12.9 (a). A current i is induced in the loop in clockwise direction and the loop segments, being still in magnetic field, experience forces, F_1 , F_2 and F_3 . The dashed lines show the limits of magnetic field. To pull the loop at a constant velocity \vec{v} towards right, it is required to apply an external force \vec{F} on the loop so as to overcome the magnetic force of equal magnitude but acting in opposite direction.

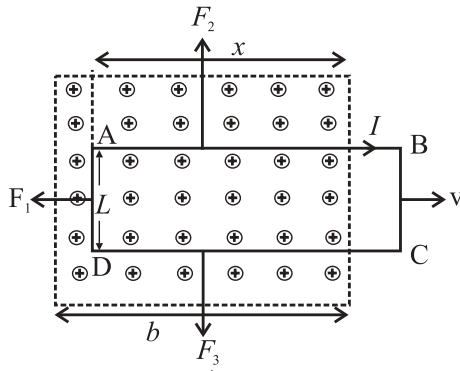

⊗ Magnetic field \vec{B} into plane of the paper

Fig. 12.9 (a): A loop is moving out of magnetic field with velocity v .

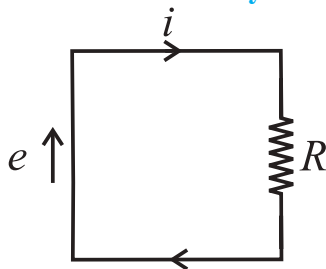

Fig. 12.9 (b) : Induced emf e , induced current i and collective resistance R of the loop.

∴ The rate of doing work on the loop is

$$P = \frac{\text{Work } (W)}{\text{time } (t)} = \frac{\text{Force } (F) \times \text{displacement } (d)}{\text{time } (t)}$$

$$P = \text{Force } (F) \times \text{velocity } (v) \\ = \vec{F} \cdot \vec{v} \quad \text{--- (12.18)}$$

We would like to find the expression for P in terms of B and the characteristics of the loop i.e., resistance (R), width (L) and Area (A).

As the loop is moved to the right, the area lying within the magnetic field decreases, thus causing a decrease in the magnetic flux linked with the moving loop. The decreasing

magnetic flux induces current in the loop as dictated by Lenz's law. The induced current in the loop gives rise to a force that opposes the pulling of the loop away from the magnetic field.

We know that magnitude of magnetic flux through the loop is

$$\phi_B = B.A = B.Lx \quad \text{--- (12.19)}$$

As x decreases, the flux decreases. According to Faraday's law, the magnitude of induced emf,

$$|e| = \left| \frac{d\phi}{dt} \right| = \frac{d}{dt}(BLx) \\ = BL \cdot \frac{dx}{dt} = BLv \quad \text{--- (12.20)}$$

The induced emf e is represented on the left and the collective resistance R of the loop on the right in the Fig. 12.9 (b). The direction of induced current i is obtained by Right-Hand (RH) Rule.

The magnitude of induced current i can be written using Eq. (12.20) as

$$i = \frac{|e|}{R} = \frac{BLv}{R} \quad \text{--- (12.21)}$$

The three segments of the current carrying loop experience the deflecting forces \vec{F}_1 , \vec{F}_2 and \vec{F}_3 in the magnetic field \vec{B} in accordance with Eq. ($\vec{F} = i \vec{L} \times \vec{B}$). From the symmetry, the forces \vec{F}_2 and \vec{F}_3 being equal and opposite, cancel each other. The remaining force \vec{F}_1 is directed opposite to the external force \vec{F} on the loop. So $\vec{F} = -\vec{F}_1$.

The magnitude of $|\vec{F}_1|$ can be written as

$$|\vec{F}_1| = i LB \sin 90 = i LB = |\vec{F}| \quad \text{--- (12.22)}$$

From Eq. (12.21) and Eq. (12.22)

$$|\vec{F}| = |\vec{F}_1| = iLB \\ = \frac{BLv}{R} \cdot LB = \frac{B^2 L^2 v}{R} \quad \text{--- (12.23)}$$

From Eq. (12.18) and (12.23), the rate of doing mechanical work, that is power:

$$P = \vec{F} \cdot \vec{v} = \frac{B^2 L^2 v}{R} \cdot v = \frac{B^2 L^2 v^2}{R} \quad \text{--- (12.24)}$$

If current i is flowing in the closed circuit with collective resistance R , the rate

of production of heat energy in the loop as we pull it along at constant speed v , can be written as

$$\text{Rate of production of heat energy} = P = i^2 R \quad \text{--- (12.25)}$$

From Eq. (12.21) and Eq. (12.25)

$$P = \left(\frac{BLv}{R} \right)^2 \cdot R$$

$$P = \frac{B^2 L^2 v^2}{R} \quad \text{--- (12.26)}$$

Comparing Eq. (12.24) and Eq. (12.26), we find that the rate of doing mechanical work is exactly same as the rate of production of heat energy in the circuit/loop.

Thus the work done in pulling the loop through the magnetic field appears as heat energy in the loop.

12.10 Eddy Currents:

Suppose the conducting loop of Fig. 12.9 (a) is replaced by a solid conducting plate, the relative motion between conductor and magnetic field induces a current in the conductor plate (Fig. 12.10 (a)). In this case again, we encounter an opposing force so we must do work while moving the conductor with uniform velocity v . The conduction electrons making up the induced current do not follow one path as they do with the loop, but swirl about within the plate as if they were caught in an eddy of water. Such a current is called an eddy current. Eddy current can be represented by a single path as shown in Fig. 12.10 (a).

The induced current in the conductor plate is responsible for transfer of the mechanical energy into heat energy. The dissipation of energy as heat energy is more apparent in the arrangement shown in Fig. 12.10 (a), where a conducting plate, free to rotate about a pivot, is allowed to swing down like a pendulum through a magnetic field. In each swing, when the plate enters and leaves the field, a portion of its mechanical energy is transformed to heat energy. After several such swings there is no

mechanical energy left with the pendulum and the converted heat energy is dissipated in the solid plate making it warm. Eddy current can be reduced by discontinuity in the structure of conductor plate as depicted in Fig. 12.10 (c).

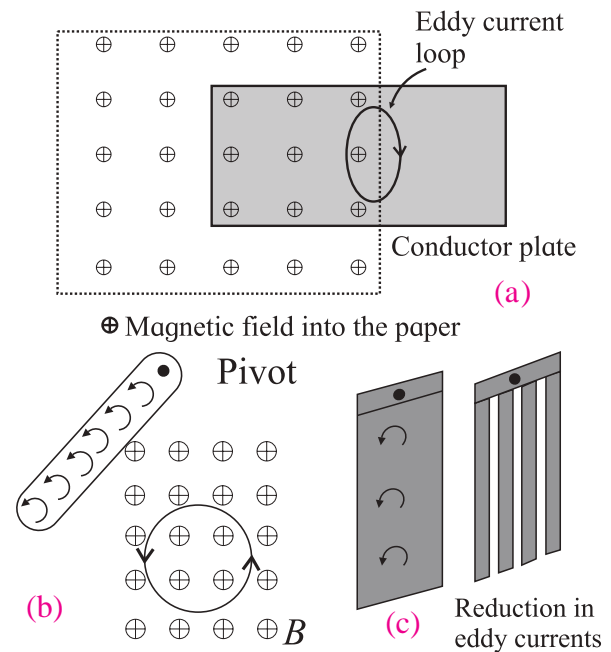

Fig. 12.10: (a) Eddy currents are induced in solid conductor plate, (b) Conducting plate swings like a pendulum, (c) Reduction in eddy currents due to discontinuous structure of a plate.

12.11 Self-Inductance:

Consider a circuit (coil) in which the current is changing. The changing current will vary the magnitude of magnetic flux linked with the coil (circuit) itself and consequently an emf will be induced in the circuit.

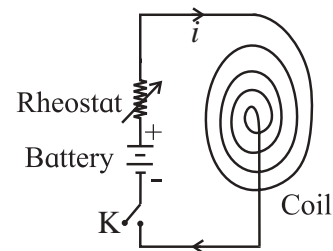

Fig. 12.11: Changing current in a coil.

The production of induced emf, in the circuit (coil) itself, on account of a change in the current in it, is termed as the phenomenon of self-inductance.

Let at any instant, the value of magnetic flux linked with the circuit itself be ϕ

corresponding to current I in it (Fig. 12.11). It is obvious that ϕ will be proportional to current I .

$$\begin{aligned} \text{i.e., } \phi &\propto I \\ \text{or } \phi &= LI \text{ or } L = \phi / I, \quad \text{--- (12.27)} \end{aligned}$$

where L is a constant of proportionality and is termed as the self-inductance (or coefficient of self induction) of the coil.

For a closely wound coil of N turns, the same magnetic flux will be linked with all the turns. When the flux through the coil changes each turn of the coil contributes towards the induced emf. Therefore a term flux linkage is used for a closely wound coil. The flux linkage for a coil with N turns corresponding to current I will be written as

$$\begin{aligned} N\phi_B &\propto I \\ N\phi_B &= LI \\ L &= N\phi_B / I \quad \text{--- (12.28)} \end{aligned}$$

The inductance (L) depends only on the geometry and material properties of the coil.

Unit of Inductance:

According to Faraday's law, induced emf e is given by

$$\begin{aligned} e &= -\frac{d\phi}{dt} \\ \text{Using Eq. (12.27)} \\ e &= -\frac{d}{dt}(LI) = -L \frac{dI}{dt} \quad \text{--- (12.29)} \end{aligned}$$

$$\text{Unit of } L = \frac{|e|}{|dI/dt|} = \left[\frac{\text{volt}}{\text{A/s}} \right] = \text{Henry}$$

Definition of L:

Self inductance L may be defined in the following ways:

(i) From Eq. (12.27), $\phi = LI$ or $L = \frac{\phi}{I}$
Hence, the self-inductance of a circuit is the ratio of magnetic flux (produced due to current in the circuit) linked with the circuit to the current flowing in it. The magnetic flux produced per unit current in the circuit is defined as its self inductance.

(ii) Using Eq. (12.29), $L = -\left(\frac{e}{dI/dt}\right)$
Hence, self-inductance of a circuit is the ratio

of induced emf (caused by changing current in the circuit) produced around the circuit to the rate of change of current in it.

In other words, the induced emf produced around the circuit per unit rate of change of current in it, is defined as the self-inductance of the circuit.

(iii) When a current increases in the circuit, an induced emf acts opposite to it. Consequently, the work will have to be done in order to establish the magnetic flux associated with a steady current I_0 in the circuit.

Work done in time dt is $dW = e \cdot I \cdot dt$

$$\begin{aligned} &= \left(-L \frac{dI}{dt}\right) \cdot (I) \cdot dt \left[\because e = -L \frac{dI}{dt}\right] \\ &= -LI \frac{dI}{dt} \cdot dt \\ &= -LI \cdot dI \end{aligned}$$

$$\therefore \text{Total work } W = \int dw = \int_0^{I_0} -LI dI$$

$$\text{or, } W = -L \cdot \frac{I_0^2}{2} \quad \text{--- (12.30)}$$

$$= \frac{1}{2} LI_0^2 \text{ (magnitude)}$$

Now if $I_0 = 1$,

$$\text{Then } W = L \cdot \frac{1}{2}$$

$$\text{or } L = + 2W \text{ (numerically)} \quad \text{--- (12.31)}$$

Hence self-inductance of a circuit is numerically equal to twice the work done in establishing the magnetic flux associated with unit current in the circuit.

This work done W , will represent the energy of the circuit.

$$\therefore \text{Energy of the circuit} = \frac{1}{2} LI_0^2 \quad \text{--- (12.32)}$$

We know that the mechanical energy is expressed in terms of kinetic energy as

$$KE = \frac{1}{2} mv^2 \quad \text{--- (12.33)}$$

Comparing the Eq. (12.33) and Eq. (12.34), we find that self inductance (L) of an electrical circuit plays the same role (electrical inertia)

as played by mass (inertia) in mechanical motion.

Inductance of a solenoid: If a current i is established in the windings (turns) of a long solenoid, the current produces a magnetic flux ϕ_B through the central region. The inductance of the solenoid is given by $L = N\phi_B/i$, where N is the number of turns. $N\phi_B$ is called as magnetic flux linkage. For a length l near the middle of the solenoid the flux linkage is $N\phi_B = (nl)(\vec{B} \cdot \vec{A}) = nlBA$, (for $\theta = 0^\circ$), where n is the number of turns per unit length, B is the magnetic field inside and A is the cross sectional area of the solenoid.

We know that the magnetic field inside the solenoid is given by Eq. (10.65) as

$$B = \mu_0 ni$$

Hence

$$L = \frac{N\phi_B}{i} = \frac{(nl)BA}{i} = \frac{nl(\mu_0 ni)A}{i} \\ = \mu_0 n^2 lA$$

where, Al is the interior volume of solenoid.

Therefore inductance per unit length near the middle of a long solenoid is

$$\frac{L}{l} = \mu_0 n^2 A = \mu_0 n^2 \left(\frac{\pi d^2}{4} \right), \quad d \text{ being the diameter of solenoid.} \quad \text{--- (12.34)}$$

This implies that inductance of a solenoid $L \propto n^2$, $L \propto d^2$. As n is a number per unit length, inductance can be written as a product of permeability constant μ_0 and a quantity with dimension of length. This implies that μ_0 can be expressed in henry/ meter (H/m).

Example 12.5: Derive an expression for the self-inductance of a toroid of circular cross-section of radius r and major radius R . Calculate the self inductance (L) of toroid for major radius (R) = 15 cm, cross-section of toroid having radius (r) = 2.0 cm and the number of turns (n) = 1200.

Solution: The magnetic field inside a toroid,

$$B = \frac{\mu_0 Ni}{2\pi r}, \text{ where } N \text{ is the number of turns}$$

and r is the distance from the toroid axis.

As $r \ll R$, magnetic field (B) in the cavity of toroid is uniform and can be written as

$$B = \frac{\mu_0 Ni}{2\pi R}$$

The magnetic flux (ϕ) passing through cavity is

$$\phi = (\pi r^2) \frac{\mu_0 Ni}{2\pi R} = \frac{\mu_0 Nir^2}{2R}$$

This is the flux that links each turn. When the current i varies with time, the induced emf e across the terminals of toroid is given by Faraday's law.

$$e = -\frac{Nd\phi}{dt} = -N \frac{d}{dt} \left(\frac{\mu_0 Nir^2}{2R} \right)$$

$$e = -N \left(\frac{\mu_0 Nr^2}{2R} \right) \frac{di}{dt}$$

Comparing with $e = -L \frac{di}{dt}$

We get,

$$L = \frac{\mu_0 N^2 r^2}{2R} \quad (\because r \ll R)$$

Given,

$N=1200$, $r=2.0$ cm, $R=15$ cm and

$\mu_0 = 4\pi \times 10^{-7}$ T.m/A.

$L = 2.41 \times 10^{-3}$ H

Example 12.6: Consider a uniformly wound solenoid having N turns and length L . The core of the solenoid is air. Find the inductance of the solenoid of $N=200$, $L=20$ cm and cross-sectional area, $A=5$ cm². Calculate the induced emf e_L , if the current flowing through the solenoid decreases at a rate of 60 A/s.

Solution: The magnetic flux through each turn of area A in the solenoid is

$$\phi_B = B \cdot A = (\mu_0 ni) \cdot A \quad (\because \text{Magnetic field inside a solenoid is } B = \mu_0 ni)$$

$$= \mu_0 (N/L) \cdot i \cdot A \quad (\because n \text{ is the number of turns per unit length} = N/L)$$

We know that the inductance (L) of the solenoid can be written as

$$L = (N\phi_B) / i$$

Substituting the value of ϕ_B , we get

$$L = (N/i) \cdot \{ \mu_0 \cdot (N/L) \cdot i \cdot A \}$$

$$L = \mu_0 \cdot (N^2/L) \cdot A$$

Inserting the given values of N , L and A , we find

$$L = (4\pi \cdot 10^{-7} \text{Tm/A}) \cdot (200)^2 (5 \cdot 10^{-4} \text{m}^2) / (20 \cdot 10^{-4} \text{m})$$

$$\text{or } L \approx 0.126 \text{ mH}$$

The induced emf in the solenoid

$$e_L = -L (di/dt)$$

$$e_L = - (0.126 \cdot 10^{-3}) (-60 \text{ A/s}) = 7.56 \text{ mV}$$

Example 12.7: The self-inductance of a closely wound coil of 200 turns is 10 mH. Determine the value of magnetic flux through the cross-section of the coil when the current passing through the coil is 4 mA.

Solution: Given :

Self-inductance of coil, $L = 10 \text{ mH}$,

Number of turns, $N = 200$, and

Current through the coil, $i = 4 \text{ mA}$

The total value of magnetic flux ϕ associated with the coil is,

$$\phi = Li$$

$$= (10 \times 10^{-3} \text{ H}) \times (4 \times 10^{-3} \text{ A})$$

$$= 4 \times 10^{-5} \text{ Wb}$$

The flux per turn (or flux through the cross-section of the coil)

$$= \frac{\phi}{N}$$

$$= \left(\frac{4 \times 10^{-5} \text{ Wb}}{200} \right)$$

$$= 2 \times 10^{-7} \text{ Wb}$$

Inductances in series or parallel:

If several inductances are connected in series or in parallel, then the total inductance is determined by using following relations:

$$L_{\text{Total}} = L_1 + L_2 + L_3 + \dots \quad (\text{Series Combination})$$

$$\frac{1}{L_{\text{Total}}} = \frac{1}{L_1} + \frac{1}{L_2} + \frac{1}{L_3} + \dots \quad (\text{Parallel Combination})$$

12.12 Energy Stored in a Magnetic Field:

We have seen that the changing magnetic flux in a coil causes an induced emf. The induced emf so produced opposes the change and hence the energy has to be spent to overcome it to build up the magnetic field. This energy may be recovered as heat in a resistance of the circuit. This fact gives the logical concept of the energy being stored in the magnetic field.

We have dealt with a similar problem in electrostatics where the total electrostatic energy U_E is stored in the medium between the plates of a capacitor with capacitance C and charge q held at potential V is

$$U_E = \frac{q^2}{2C} = \frac{CV^2}{2} \quad [\because q = CV]$$

Now we can estimate the energy spent to build up a current I in a circuit having an inductance L .

From Eq. (12.29),

$$\text{The induced emf } e = -L \frac{dI}{dt}$$

The work done in moving a charge dq against this emf is

$$dw = -e \cdot dq = L \frac{dI}{dt} \cdot dq$$

$$= L \cdot \frac{dI \cdot dq}{dt}$$

$$= L \cdot I \cdot dI \quad \left[\because \frac{dq}{dt} = I \right]$$

Therefore total work

$$W = \int dw = \int_0^I LI dI = \frac{1}{2} LI^2 = U_B \quad \dots (12.35)$$

This is the energy stored (U_B) in magnetic field and is analogous to the energy stored (U_E) in the electric field in a capacitor given above. It can be shown that this energy stored up in magnetic field per unit volume (u_B) comes out to be $(B^2/2 \mu_0)$ Joules, which parallels the $(1/2)\epsilon_0 E^2$, the energy density (u_E) in an electric field E , μ_0 and ϵ_0 being the permeability and permittivity of free space.

12.13 Energy Density of a Magnetic Field:

Consider a long solenoid having length, l near the middle, cross-sectional area \bar{A} and carrying a current i through it (Fig. 12.12). The volume associated with length l will be $A \cdot l$. The energy, U_B stored by the length l of the solenoid must lie entirely within volume Al , because the magnetic field outside the solenoid is almost zero. Moreover, the energy stored will be uniformly distributed within the volume as the magnetic field \vec{B} is uniform everywhere inside the solenoid.

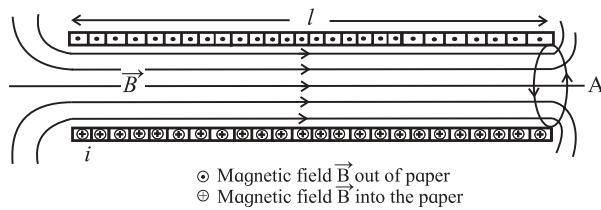

Fig 12.12 : A current carrying solenoid produces uniform magnetic field in the interior region.

Thus, the energy stored, per unit volume, in the magnetic field is

$$u_B = \frac{U_B}{A \cdot l} \quad \text{--- (12.36)}$$

From Eq. 12.35, we know that $U_B = \frac{1}{2} LI^2$

$$\therefore u_B = \frac{1}{2} LI^2 \cdot \frac{1}{A \cdot l} = \left(\frac{L}{l}\right) \cdot \frac{I^2}{2A} \quad \text{--- (12.37)}$$

For a long solenoid, we know that the inductance (L) per unit length is given by Eq. (12.34) as

$$\left(\frac{L}{l}\right) = \mu_0 n^2 A,$$

where L is the inductance of a long solenoid having length l in the middle, n is the number of turns per unit length, and A is the cross-sectional area of the solenoid, μ_0 is the permeability constant for air ($4\pi \times 10^{-7}$ T.m/A or $4\pi \times 10^{-7}$ H/m) [$\therefore 1$ H (Henry) = 1 T.m²/A] Substituting the value of (L/l) in Eq. (12.37), we get

$$\therefore u_B = \mu_0 n^2 A \cdot \frac{I^2}{2A}$$

$$u_B = \frac{1}{2} \mu_0 n^2 I^2 \quad \text{--- (12.38)}$$

For a solenoid the magnetic field at

interior points is given by Eq. (10.65) as $B = \mu_0 I n$.

Therefore, the expression for energy density (u_B) stored in magnetic field can be written as

$$u_B = \frac{B^2}{2\mu_0} \quad \text{--- (12.39)}$$

This equation gives the density of stored energy at any point where magnetic field is B . This equation holds good for all magnetic fields, no matter how they are produced.

Example 12.8 : Calculate the self-inductance of a coaxial cable of length l and carrying a current I . The current flows down the inner cylinder with radius a , and flows out of the outer cylinder with radius b .

Solution: According to Ampere's law, the magnetic field (B) between two cylinders at a distance r from the axis is given by

$$B = \frac{\mu_0 I}{2\pi r}.$$

The magnetic field is zero elsewhere.

We also know that the magnetic energy density,

$$u_B = \frac{B^2}{2\mu_0} = \frac{1}{2\mu_0} \left(\frac{\mu_0^2 I^2}{4\pi^2 r^2} \right) = \frac{\mu_0 I^2}{8\pi^2 r^2}$$

Energy stored in a cylindrical shell of length l , radius r and thickness dr is given by

$$\left(\frac{\mu_0 I^2}{8\pi^2 r^2} \right) \times 2\pi l r dr = \frac{\mu_0 I^2 l}{4\pi} \left(\frac{dr}{r} \right)$$

Integrating from a to b , we get

$$W = \frac{\mu_0 I^2 l}{4\pi} \ln \left(\frac{b}{a} \right)$$

Magnetic energy confined in an inductor (L) carrying a current (I) can also be written as $\frac{1}{2} LI^2$. Comparing the two expressions we find the inductance of coaxial cable as

$$L = \frac{\mu_0 l}{2\pi} \ln \left(\frac{b}{a} \right)$$

12.14 Mutual Inductance (M):

Let us consider a case of two coils placed side by side as shown in Fig. 12.13. Suppose a fixed current I_1 is flowing through coil 1. Due to this current a magnetic field B_1 (x, y, z) will be produced in the nearby region surrounding the coil 1. Let ϕ_{21} be the magnetic flux linked

with the surface area s_2 of the coil 2 due to magnetic field \vec{B}_1 and can be written as

$$\phi_{21} = \int_{s_2} \vec{B}_1 \cdot \vec{\delta a}, \quad \text{--- (12.40)}$$

where s_2 represents the effective surface (or area) enclosed by coil 2. If the positions of the coils are fixed in space,

Then $\phi_{21} \propto I_1$

$$\phi_{21} = \text{constant} \cdot I_1$$

or $\phi_{21} = M_{21} I_1$ --- (12.41)

where, M_{21} is a constant of proportionality and is termed as mutual inductance or coefficient of mutual induction of coil 2 (or circuit c_2) with respect to coil 1 (or circuit c_1). Suppose I_1 changes slowly with time then magnetic field B_1 in the vicinity of coil 2 is related to current I_1 in coil 1 in the same way as it would be related for a steady current. The magnetic flux ϕ_{21} will change in proportion as I_1 changes.

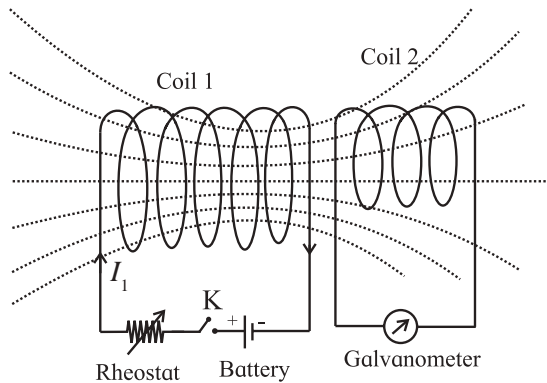

Fig. 12.13: Mutual inductance of two coils.

The induced emf in coil 2 will be written as

$$e_{21} = -\frac{d\phi_{21}}{dt}$$

$$e_{21} = -M_{21} \frac{dI_1}{dt}$$

Now we allow current I_2 to flow through coil 2. On account of this current, magnetic flux ϕ_{12} linked with coil 1 is obviously proportional to I_2 .

That is

$$\phi_{12} \propto I_2$$

$$\text{or } \phi_{12} = M_{12} I_2 \quad \text{--- (12.42)}$$

$$\text{or } M_{12} = \frac{\phi_{12}}{I_2} \quad \text{--- (12.43)}$$

M_{12} is known as mutual inductance of coil 1 with respect to coil 2. The induced emf in coil 1 will be

$$e_{12} = -M_{12} \frac{dI_2}{dt} \quad \text{--- (12.44)}$$

It may be noted that by symmetry, $M_{12} = M_{21} = M$.

Alternative definitions of mutual inductance:

It is evident from the Eq. (12.41) and Eq. (12.42) that

$$\phi_{21} = MI_1 \text{ and } \phi_{12} = MI_2$$

$$\text{or } M = \frac{\phi_{21}}{I_1} = \frac{\phi_{12}}{I_2} \quad \text{--- (12.45)}$$

Hence, the mutual inductance of two circuits is equal to the magnetic flux linked with one circuit per unit current in the other circuit. The circuit in which current is provided by an external source is usually referred to as primary circuit while the other as secondary.

Therefore, the mutual inductance M of two circuits (or coils) is the magnetic flux (ϕ_s) linked with the secondary circuit per unit current (I_p) of the primary circuit.

$$\therefore M = \frac{\phi_s}{I_p}$$

$$\text{or } \phi_s = MI_p \quad \text{--- (12.46)}$$

Also from Faraday's law

$$e_s = -\frac{d\phi_s}{dt} = -\frac{d}{dt}(MI_p) = -M \frac{dI_p}{dt}$$

$$\text{or } M = \left| \frac{e_s}{(dI_p / dt)} \right| \quad \text{--- (12.47)}$$

Hence, mutual inductance is defined as the value of induced emf produced in the secondary circuit per unit rate of change in current in the primary circuit.



Use your brain power

It can be shown that the mutual potential energy of two circuits is $W = MI_1 I_2$. Therefore, the mutual inductance (M) may also be defined as the mutual potential energy (W) of two circuits corresponding to unit current flowing in each circuit.

$$M = \frac{W}{I_1 I_2}$$

$$M = W [I_1 = I_2 = I]$$

The unit of mutual inductance is henry (H).

$$\text{henry} = \frac{\text{volt}}{\text{As}} = \text{ohm} \cdot \text{s}$$

$$1 \text{ henry} = 1 \text{ ohm} \cdot \text{s}$$

If corresponding to 1 A/s rate of change of current in the primary circuit, the induced emf produced in the secondary circuit is 1 volt, then the mutual inductance (M) of the two circuits is 1 H.

Example 12.9 : Mutual inductance of the wireless charging system.

In a wireless battery charger, the base unit can be imagined as a solenoid (coil B) of length l with N_B turns, carrying a current i_B and having a cross-section area A . The handle coil (coil H) has N_H turns and surrounds the base solenoid (coil B) completely. The base unit is designed to hold the handle of the charging unit. The handle has a cylindrical hole so that it fits loosely over a matching cylinder on the base unit. When the handle is placed on the base, the current flowing in coil B induces a current in the coil H. Thus, the induced current in the coil H is used to charge the battery housed in the handle.

The magnetic field due to a solenoid coil B,

$$B_{\text{solenoid}} = \mu_0 n i = \mu_0 \left(\frac{N_B}{l} \right) i$$

Magnetic flux through coil H caused by the magnetic field B_{solenoid} due to solenoid coil B,

$$\phi_H = B_{\text{solenoid}} A$$

$$\text{Flux linkage} = N_H \phi_H$$

The mutual inductance (M) of the wireless charging system,

$$\begin{aligned} M &= \frac{N_H B_{\text{solenoid}} A}{i} = \mu_0 \left(\frac{N_B}{l} \right) A \cdot N_H \\ &= \mu_0 \left(\frac{N_B N_H}{l} \right) A \end{aligned}$$

Coefficient of coupling between two circuits:

The coefficient of coupling (K) is a measure of the portion of flux that reaches coil 2 which is in the vicinity of coil 1. The greater is the coefficient

of coupling the greater will be the mutual inductance (M).

Inductance of any circuit is proportional to the induced voltage it can develop. This is equally true for mutual inductance.

$M \propto e_{21}$, where e_{21} is induced emf developed in coil 2 due to the portion of the flux from coil 1 reaching coil 2 ($= K \phi_1$).

But induced emf is also proportional to the number of turns in the coil,

$$\text{So, } e_{21} \propto N_2 (K \phi_1)$$

$$\text{But } \phi_1 \propto N_1$$

$$\therefore e_{21} \propto N_2 (K N_1)$$

$$\text{Also } L \propto N^2 \text{ or } N \propto \sqrt{L}$$

$$\therefore N_1 N_2 \propto \sqrt{L_1} \sqrt{L_2} = \sqrt{L_1 L_2}$$

Replacing e_{21} with M , we now have

$$M = K \sqrt{L_1 L_2} \quad \text{--- (12.48)}$$

K is usually less than unity. If $K = 1$, the two coils will be perfectly coupled, and $M = \sqrt{L_1 L_2}$.

(i) If $K > 0.5$, the two coils are tightly coupled

(ii) If $K < 0.5$, the coils are loosely coupled.

(iii) If $L_1 = L_2$, then a coil with self-inductance L is coupled to itself with mutual inductance

$$M = \sqrt{L_1 L_2} = \sqrt{L^2} = L$$

It may not be always desirable to have a large value of mutual inductance (M). A large value of M is desirable for a transformer but higher M is not desirable for home appliances such as a electric clothes dryer. A dangerous emf can be induced on the metallic case of the dryer if the mutual inductance between its heating coils and the case is large. In order to minimise M the heating coils are counter wound so that their magnetic fields cancel one another and reduces M with the case of the dryer.

Theoretically, the coupling between two coils is never perfect. If two coils are wound on a common iron core, the coefficient of coupling (K) can be considered as unity. For two air-core coils or two coils on separate iron cores, the coefficient of coupling depends on the distance between two coils and the angle

between the axes of the two coils. When the coils are parallel (and in line), the coefficient K is maximum. If the axes of the coils are at right angles (and in line), K is minimum. If we want to prevent interaction between the coils, the coils should be oriented at right angle to each other and be kept as far apart as possible. K -value for radio coils (Radio frequency, intermediate frequency transformers) lies between 0.001 to 0.05.



Use your brain power

Prove that the inductance of parallel wires of length l in the same circuit is given by

$$L = \left(\frac{\mu_0 l}{\pi} \right) \ln(d/a),$$

where a is the radius of wire and d is separation between wire axes.

Example 12.10: Two coils having self inductances $L_1 = 75$ mH and $L_2 = 55$ mH are coupled with each other. The coefficient of coupling (K) is 0.75 calculate the mutual inductance (M) of the two coils.

Solution : Given :

$$L_1 = 75 \text{ mH}, L_2 = 55 \text{ mH}, K = 0.75.$$

We know that,

$$M = K \sqrt{L_1 L_2}$$

$$= 0.75 \sqrt{75 \times 55} \text{ mH}$$

$$M = 48.2 \text{ mH}$$

Example 12.11: The mutual inductance (M) of the two coils is given as 1.5 H. The self inductances of the coils are :

$L_1 = 5$ H, $L_2 = 4$ H. Find the coefficient of coupling between the coils.

Solution:

Given $L_1 = 5$ H

$L_2 = 4$ H

$M = 1.5$ H.

$$K = \frac{M}{\sqrt{L_1 L_2}} = \frac{1.5}{\sqrt{5 \times 4}}$$

$$= 0.335 = 33.5\%$$

12.15 Transformer:

Mutual inductance, is the basis of all types of transformers. A transformer is a device used for changing the voltage of alternating current from low value to high value or vice versa. We can see the transformers by road sides in villages and cities.

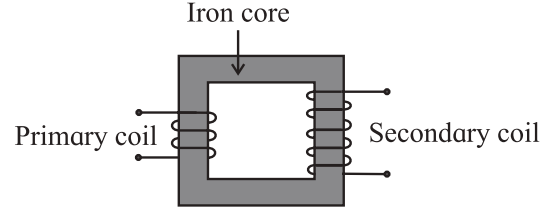

Fig. 12.14: Transformer consisting of primary and secondary coils wound on a soft iron core.

Whenever the magnetic flux linked with a coil changes, an emf is induced in the neighbouring coil. In a transformer there are two coils, primary (p) and secondary (s) insulated from each other and wound on a soft iron core as shown in Fig. 12.14. Primary and secondary coils are called input and output coils respectively.

When an AC voltage is applied to the primary coil, the current through the coil changes sinusoidally causing similar changes in the magnetic flux through the core. As the changing magnetic flux is linked with both primary and secondary coils, emf is induced in each coil. The magnetic flux linked with the coil depends upon the number of turns in the coil.

Let ϕ be the magnetic flux linked per turn with both the coils at an instant t . N_p and N_s be the number of turns in the primary and secondary coil respectively.

Then at the instant t , the magnetic flux linked with primary coil $\phi_p = N_p \phi$, and with secondary coil $\phi_s = N_s \phi$.

The induced emf in primary and secondary coil will be

$$e_p = - \frac{d\phi_p}{dt} = -N_p \frac{d\phi}{dt}$$

and $e_s = -N_s \frac{d\phi}{dt}$

$$\therefore \frac{e_s}{e_p} = \frac{N_s}{N_p}$$

--- (12.49)

The ratio N_s/N_p is called turn ratio (transformer ratio) of the transformer. Equation (12.49) is known as equation for transformer.

For an ideal transformer,
input power = Output power

$$e_p i_p = e_s i_s$$

$$\frac{e_s}{e_p} = \frac{i_p}{i_s} \quad \text{--- (12.50)}$$

Combining Eqs. (12.49) and (12.50)

$$\frac{e_s}{e_p} = \frac{N_s}{N_p} = \frac{i_p}{i_s} \quad \text{--- (12.51)}$$

Case 1: When $N_s > N_p$

then $e_s > e_p$ (step up transformer)

and $i_p > i_s$. Current in the primary coil is more than that in the secondary coil.

Case 2: When $N_s < N_p$

then $e_s < e_p$ (step down transformer)

and $i_p < i_s$. Current in primary coil is less than that in secondary coil

Do you know?

Faraday's laws have found innumerable applications in modern world. Some common examples are: Electric Guitar hard drives, Smart cards, Microphones, etc. Hybrid cars: In modern days, the electric and hybrid vehicles take advantage of electromagnetic induction. The limitation of such vehicles is the life-time of a battery which is not long enough to get similar drive from a full tank of fuel/ petrol. In order to increase the amount of charge in the battery, the car acts as a generator whenever it is applying the brakes. At the time of braking, the frictional force between the tyres and the ground provides the necessary torque to the magnets inside the generator. Thus, the car takes advantage of back emf which helps in charging the battery and consequently leads to a longer drive.

Do you know?

1. The flux rule is the terminology that Feynman used to refer to the law relating magnetic flux to emf. (RP Feynman, Feynman lectures on Physics, Vol II)
2. The Faraday's law relating flux to emf is referred to by Griffiths as the 'Universal flux rule'. Griffiths used the term 'Faraday's law' to refer to what he called- Maxwell-Faraday equation. (DJ Griffiths, Introduction to electrodynamics 3rd Ed)

Internet my friend

https://en.wikipedia.org/wiki/Electromagnetic_induction

Do you know?

Accelerator in India:
Microtron Accelerator for electrons at Savitribai Phule Pune University

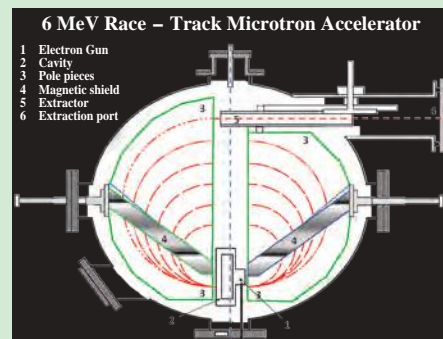

Picture credit: Dr. S.D. Dhole
Department of Physics SPPU.



Exercises

1. Choose the correct option.

- i) A circular coil of 100 turns with a cross-sectional area (A) of 1 m^2 is kept with its plane perpendicular to the magnetic field (B) of 1 T . What is the magnetic flux linkage with the coil?
 (A) 1 Wb (B) 100 Wb
 (C) 50 Wb (D) 200 Wb
- ii) A conductor rod of length (l) is moving with velocity (v) in a direction normal to a uniform magnetic field (B). What will be the magnitude of induced emf produced between the ends of the moving conductor?
 (A) BLv (B) BLv^2
 (C) $\frac{1}{2}Blv$ (D) $\frac{2Bl}{v}$
- iii) Two inductor coils with inductance 10 mH and 20 mH are connected in series. What is the resultant inductance of the combination of the two coils?
 (A) 20 mH (B) 30 mH
 (C) 10 mH (D) $\frac{20}{3} \text{ mH}$
- iv) A current through a coil of self inductance 10 mH increases from 0 to 1 A in 0.1 s . What is the induced emf in the coil?
 (A) 0.1 V (B) 1 V
 (C) 10 V (D) 0.01 V
- v) What is the energy required to build up a current of 1 A in an inductor of 20 mH ?
 (A) 10 mJ (B) 20 mJ
 (C) 20 J (D) 10 J

2. Answer in brief.

- i) What do you mean by electromagnetic induction? State Faraday's law of induction.
- ii) State and explain Lenz's law in the light of principle of conservation of energy.
- iii) What are eddy currents? State applications of eddy currents.

- iv) If a copper disc swings between the poles of a magnet, the pendulum comes to rest very quickly. Explain the reason. What happens to the mechanical energy of the pendulum?
- v) Explain why the inductance of two coils connected in parallel is less than the inductance of either coil.
3. In a Faraday disc dynamo, a metal disc of radius R rotates with an angular velocity ω about an axis perpendicular to the plane of the disc and passing through its centre. The disc is placed in a magnetic field B acting perpendicular to the plane of the disc. Determine the induced emf between the rim and the axis of the disc.
 [Ans: $\frac{1}{2}(B\omega R^2)$]
4. A horizontal wire 20 m long extending from east to west is falling with a velocity of 10 m/s normal to the Earth's magnetic field of $0.5 \times 10^{-4} \text{ T}$. What is the value of induced emf in the wire?
 [Ans: 10 mV]
5. A metal disc is made to spin at 20 revolutions per second about an axis passing through its centre and normal to its plane. The disc has a radius of 30 cm and spins in a uniform magnetic field of 0.20 T , which is parallel to the axis of rotation. Calculate
- The area swept out per second by the radius of the disc,
 - The flux cut per second by a radius of the disc,
 - The induced emf in the disc.
- [Ans: (a) 5.65 m^2 , (b) 1.130 Wb , (c) 1.130 V]
6. A pair of adjacent coils has a mutual inductance of 1.5 H . If the current in one coil changes from 0 to 10 A in 0.2 s , what is the change of flux linkage with the other coil?

[Ans: 75 Wb]

7. A long solenoid consisting of 1.5×10^3 turns/m has an area of cross-section of 25 cm^2 . A coil C, consisting of 150 turns (N_c) is wound tightly around the centre of the solenoid. Calculate for a current of 3.0 A in the solenoid
- the magnetic flux density at the centre of the solenoid,
 - the flux linkage in the coil C,
 - the average emf induced in coil C if the current in the solenoid is reversed in direction in a time of 0.5 s.
- ($\mu_0 = 4\pi \times 10^{-7} \text{ T.m/A}$)
[Ans: (a) $5.66 \times 10^{-3} \text{ T}$, (b) $2.12 \times 10^{-3} \text{ Wb}$, (c) $8.48 \times 10^{-3} \text{ V}$]
8. A search coil having 2000 turns with area 1.5 cm^2 is placed in a magnetic field of 0.60T. The coil is moved rapidly out of the field in a time of 0.2 second. Calculate the induced emf across the search coil.
[Ans: 0.9 V]
9. An aircraft of wing span of 50 m flies horizontally in earth's magnetic field of $6 \times 10^{-5} \text{ T}$ at a speed of 400 m/s. Calculate the emf generated between the tips of the wings of the aircraft.
[Ans: 1.2 V]
10. A stiff semi-circular wire of radius R is rotated in a uniform magnetic field B about an axis passing through its ends. If the frequency of rotation of wire be f, calculate the amplitude of alternating emf induced in the wire.
[Ans: $e_0 = \pi^2 BR^2 f$]
11. Calculate the value of induced emf between the ends of an axle of a railway carriage 1.75 m long travelling on level ground with a uniform velocity of 50 km per hour. The vertical component of Earth's magnetic field (B_v) is given to be $5 \times 10^{-5} \text{ T}$.
[Ans: 0.122 mV]
12. The value of mutual inductance of two coils is 10 mH. If the current in one of the coil changes from 5A to 1A in 0.2 s, calculate the value of emf induced in the other coil. Also calculate the value of induced charge passing through the coil if its resistance is 5 ohm.
[Ans: 8 m C]
13. An emf of 96.0 mV is induced in the windings of a coil when the current in a nearby coil is increasing at the rate of 1.20 A/s. What is the mutual inductance (M) of the two coils?
[Ans: 80 mH]
14. A long solenoid of length l , cross-sectional area A and having N_1 turns (primary coil) has a small coil of N_2 turns (secondary coil) wound about its centre. Determine the Mutual inductance (M) of the two coils.
[Ans: $M = \mu_0 N_1 N_2 A$]
15. The primary and secondary coil of a transformer each have an inductance of $200 \times 10^{-6} \text{ H}$. The mutual inductance (M) between the windings is $4 \times 10^{-6} \text{ H}$. What percentage of the flux from one coil reaches the other?
[Ans: 2%]
16. A toroidal ring, made from a bar of length (l) 1 m and diameter (d) 1 cm, is bent into a circle. It is wound tightly with 100 turns per cm. If the permeability of bar is equal to that of free space (μ_0), calculate the magnetic field inside the bar (B) when the current (i) circulating through the turns is 100 A. Also determine the self-inductance (L) of the coil.
[Ans: 1.256T, 10mH]
17. A uniform magnetic field $B(t)$, pointing upward fills a circular region of radius, s in horizontal plane. If B is changing with time, find the induced electric field.
[Ans: $-\pi s^2 \frac{dB}{dt}$]

13. AC Circuits



Can you recall?

1. What is Faraday's laws of induction?
2. What is induced current?
3. What is an AC generator?
4. What are alternating current and direct current?
5. How is the emf generated in an AC Generator.

13.1 Introduction:

In school you have learnt that there are two types of supplies of electricity:

- (i) DC, the direct current which has fixed polarity of voltage (the positive and negative ends of the power supply are fixed).
- (ii) AC, the alternating current for which the polarity of the voltage keeps changing periodically.

We have studied the generation of AC voltage in the previous chapter. Because of low cost and convenience of transport, the electricity is mostly supplied as AC. Some of the appliances that we use at home or offices like TV, computer, transistor, radio, etc. convert AC to DC by using a device like rectifier (which you will study in chapter 16) before using it. However, there are some domestic devices like fan, fridge, air conditioner, induction heater, coil heater, etc., which



Remember this

AC shock is attractive, while DC shock is repulsive, so 220V AC is more dangerous than 220V DC. Also 220 V AC has a peak value $E_0 = \pm \sqrt{2} E_{\text{rms}} = \pm 1.414 \times 220 \text{ V} = \pm 311 \text{ V}$ but DC has fixed value of 220 V only.

run directly on AC. Almost all these devices use components like an inductor

and a capacitor. In this chapter we will study the passage of AC through resistors, inductors and capacitors.

13.2 AC Generator:

In the last chapter we have studied that the source of AC (generator) produces a time dependent emf (e) given by

$$e = e_0 \sin \omega t \quad \text{--- (13.1)}$$

Where e_0 is the peak value of emf and ω is the angular frequency of rotation of the coil in the AC generator.

As the time variation of current is similar to that of emf, the current in a circuit connected to this generator will be of the form

$$i = i_0 \sin (\omega t + \alpha)$$

where α represent the phase difference between the current (i) and the emf, and i_0 is the peak value of current. From Eq (13.1) it can be seen that the induced emf varies sinusoidally with time as shown in Fig. 13.1 below.

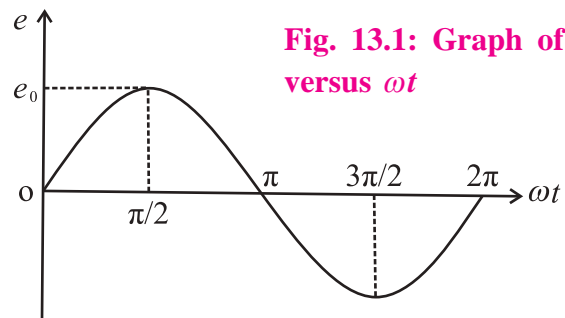

Fig. 13.1: Graph of e versus ωt

From the graph it can be seen that the direction of the emf is reversed after every half revolution of the coil. This type of emf is called the alternating emf and the corresponding current is called alternating current.

13.3. Average and RMS values:

Alternating voltages and current go through all values between zero and the peak value in one cycle.

Peak value: Peak value of an alternating current (or emf) is the maximum value of the current (or emf) in either direction.

We define some specific values which would be convenient for comparing two voltage or current waveforms.

a) Average or mean value of AC:

This is the average of all values of the voltage (or current) over one half cycle. As can be seen in Fig. 13.1, the average over a full cycle is always zero since the average value of $\sin \omega t$ over a cycle is zero. So the mean value of AC over a cycle has no significance and the mean value of AC is defined as the average over half cycle.

Average value of $\sin \theta$ in the range 0° to π°

$$\begin{aligned} \langle \sin \theta \rangle &= \frac{\int_0^\pi \sin \theta d\theta}{\int_0^\pi d\theta} = \frac{[-\cos \theta]_0^\pi}{[\theta]_0^\pi} \\ &= \frac{2}{\pi} = 0.637 \end{aligned}$$

Therefore, average value of current or emf = $0.637 \times$ their peak value

i.e., $i_{av} = 0.637 i_0$ and $e_{av} = 0.637 e_0$ where i_{av} and e_{av} are the average values of alternating current and emf (voltage) respectively.

b) Root-mean-square (or rms) value:

A moving coil ammeter and voltmeter measure the average value of current and voltage applied across it respectively. It is obvious therefore that the moving coil instruments cannot be used to measure the alternating current and voltages. Hence in order to measure these quantities it is necessary to make use of a property which does not depend upon the changes in direction of alternating current or voltage. Heating effect depends upon the square of the current (the square of the current is always positive) and hence does not depend upon the direction of flow of current. Consider an alternating current of peak value i_0 , flowing through a resistance R . Let H be the heat produced in time t . Now the same quantity of heat (H) can be produced in

the same resistance (R) in the same time (t) by passing a steady current of constant magnitude through it. The value of such steady current is called the effective value or virtual value or rms value of the given alternating current and is denoted by i_{rms} . The relation between the rms value and peak value of alternating current is given by

$$\begin{aligned} i_{rms}^2 &= \frac{\int_0^{2\pi} i^2 d\theta}{2\pi} = \frac{1}{2\pi} \int_0^{2\pi} i_0^2 \sin^2 \theta d\theta \\ &= \frac{i_0^2}{2\pi} \int_0^{2\pi} \frac{(1 - \cos 2\theta)}{2} d\theta \\ &= \frac{i_0^2}{2 \times 2\pi} \left[\left(\theta - \frac{\sin 2\theta}{2} \right) \right]_0^{2\pi} \\ &= \frac{i_0^2}{2} \\ \therefore i_{rms} &= \frac{i_0}{\sqrt{2}} = 0.707 i_0 \end{aligned}$$

Similarly it can be shown that

$$e_{rms} = \frac{e_0}{\sqrt{2}} = 0.707 e_0$$

The heat produced by a sinusoidally varying AC over a complete cycle will be given by

$$\begin{aligned} H &= \int_0^{2\pi/\omega} i^2(t) R dt \\ &= \frac{R}{\omega} \int_0^{2\pi/\omega} i^2(\omega t) d(\omega t) \\ &= \frac{2\pi R i_0^2}{\omega \cdot 2} \\ H &= R(i_{rms})^2 \cdot \frac{2\pi}{\omega} \end{aligned}$$

It is the same as the heat produced by a DC current of magnitude i_{rms} for time $t = \frac{2\pi}{\omega}$.

Example 13.1: An alternating voltage is given by $e = 6 \sin 314 t$. find (i) the peak value (ii) frequency (iii) time period and (iv) instantaneous value at time $t = 2$ ms

Solution:

$$e = e_0 \sin \omega t$$

$$e = 6 \sin 314 t$$

(i) Comparing the two equations, the peak value of the alternating voltage is $e_0 = 6 \text{ V}$

(ii) $\omega t = 314 t \therefore 2\pi f t = 314 t$

$$\text{Frequency } f = \frac{314}{2\pi} = 50 \text{ Hz}$$

(iii) Time period $T = \frac{1}{f} = \frac{1}{50} = 0.02 \text{ s}$

(iv) The instantaneous value of the voltage
At $t = 2 \times 10^{-3} \text{ s}$ is $e = 6 \sin 314 \times 2 \times 10^{-3}$
 $= 6 \text{ V}$

13.4 Phasors:

The study of AC circuits is much simplified, if we represent alternating current and alternating emf as rotating vectors with the angle between them equal to the phase difference between the current and emf. These rotating vectors are called phasors.

A rotating vector that represents a quantity varying sinusoidally with time is called a **phasor** and the diagram representing it is called **phasor diagram**.

The phasor for alternating emf and alternating current are inclined to the horizontal axis at angle ωt or $\omega t + \alpha$. and rotate in anticlockwise direction. The length of the arrow represents the maximum value of the quantity (i_0 and e_0).

The projection of the vector on fixed axis gives the instantaneous value of alternating current and alternating emf. In sine form, ($i = i_0 \sin \omega t$) and ($e = e_0 \sin \omega t$) projection is taken on Y-axis as shown in Fig. 13.2 (a). In cosine form $i = i_0 \cos \omega t$ and $e = e_0 \cos \omega t$ projection is taken X-axis on as shown in Fig. 13.2 (b).

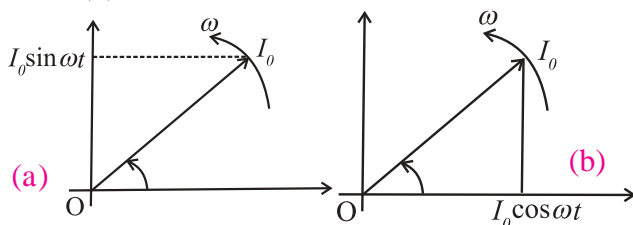

Fig. 13.2 (a) and (b): Phasor diagrams.

The representation of the harmonically varying quantities as rotating vectors enable us to use the laws of vector addition for adding these quantities.

13.5 Different Types of AC Circuits:

In this section we will derive voltage current relations for individual as well as combined circuit elements like resistors, inductors and capacitors, carrying a sinusoidal current. We assume the capacitor and inductor to be ideal unless otherwise specified.

(a) AC voltage applied to a resistor:

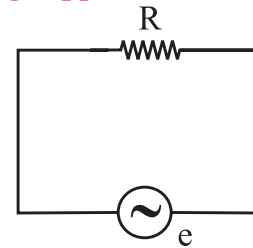

Fig.13.3 An AC voltage applied to a resistor.

Suppose a resistor of resistance R is connected to an AC source of emf with instantaneous value e given by

$$e = e_0 \sin \omega t \quad \text{--- (13.2)}$$

Where e_0 is the peak value of the voltage and ω is its angular frequency. Let e be the potential drop across the resistance.

$$\therefore e = iR \quad \text{--- (13.3)}$$

\therefore instantaneous emf = instantaneous value of potential drop

From Eq (13.2) and Eq (13.3) we have,

$$iR = e = e_0 \sin \omega t$$

$$\therefore i = \frac{e}{R} = \frac{e_0 \sin \omega t}{R}$$

$$\therefore i = i_0 \sin \omega t \quad \left(\because i_0 = \frac{e_0}{R} \right) \quad \text{--- (13.4)}$$

Comparing $i_0 = \frac{e_0}{R}$ with Ohm's law, we find that resistors behave similarly for both AC and DC voltage. Hence the behaviour of R in DC and AC circuits is the same. R can reduce DC as well as AC equally effectively.

From Eq (13.2) and Eq (13.4) we know that for a resistor there is zero phase difference between instantaneous alternating current and instantaneous alternating emf, i.e., they are in phase. Both e and i reach zero, minimum and

maximum values at the same time as shown in Fig. 13.4.

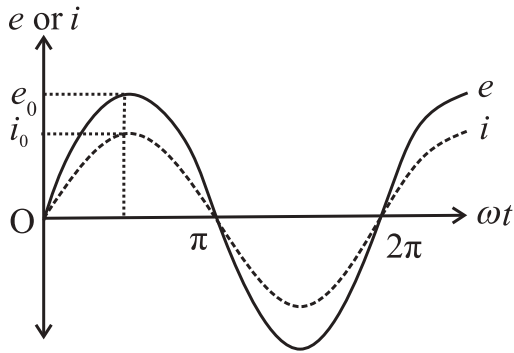

Fig. 13.4 Graph of e and i versus ωt .

Phasor diagram:

In the AC circuit containing R only, current and voltage are in the same phase, hence both phasors for i and for e are in the same direction making an angle ωt with OX. Their projections on vertical axis give their instantaneous values. The phase angle between alternating current and alternating voltage through R is zero as shown in Fig. 13.5.

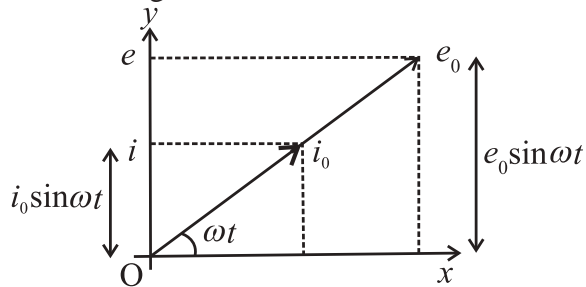

Fig. 13.5 Phasor diagram for a purely resistive circuit.

Example 13.2: An alternating voltage given by $e = 140 \sin 3142 t$ is connected across a pure resistor of 50Ω . Find (i) the frequency of the source (ii) the rms current through the resistor.

Solution: Given

$$e = 140 \sin 3142 t$$

$$R = 50 \Omega$$

i) On comparing with $e = e_0 \sin \omega t$

We get

$$\omega = 3142, e_0 = 140 \text{ V}$$

$$\omega = 2\pi f \therefore f = \frac{\omega}{2\pi} = \frac{3142}{2 \times 3.142} = 50 \text{ Hz}$$

(ii) $e_0 = 140 \text{ V}$

$$e_{\text{rms}} = \frac{e_0}{\sqrt{2}} = \frac{140}{\sqrt{2}} = 99.29 \text{ V}$$

$$\therefore i_{\text{rms}} = \frac{e_{\text{rms}}}{R} = \frac{99.29}{50} = 1.98 \text{ A}$$



Activity

Take 2 identical thin insulated copper wires about 10 cm long, imagine one of them in a zigzag form (called A) and the other in the form of a compact coil of average diameter not more than 5 cm (called B). Connect the two independently to 1.5 V cell or to a similar DC voltage and record the respective current passing through them as I_A and I_B . You will notice that the two are the same.

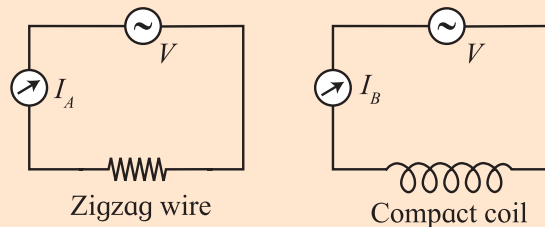

(b) AC voltage applied to an Inductor:

Let us now connect the source of alternating emf to a circuit containing pure inductor (L) only as shown in Fig. 13.6. Let us assume that the inductor has negligible resistance. The circuit is therefore a purely inductive circuit. Suppose the alternating emf supplied is represented by

$$e = e_0 \sin \omega t \quad \text{--- (13.5)}$$

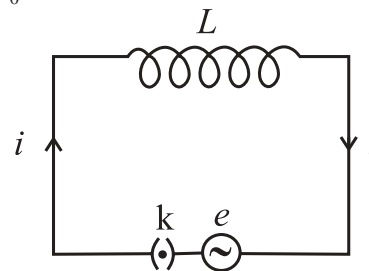

Fig. 13.6: An AC source connected to an Inductor.

When the key k is closed, current i begins to grow in the inductor because magnetic flux linked with it changes and induced emf is produced which opposes the applied emf (Faraday's law).

According to Lenz's law

$$e = -L \frac{di}{dt} \quad \text{--- (13.6)}$$

Where e is the induced emf and $\frac{di}{dt}$ is the rate of change of current.

To maintain the flow of current in the circuit, applied emf (e) must be equal and opposite to the induced emf (e'). According to Kirchhoff's voltage law as there is no resistance in the circuit,

$$e = -e'$$

$$\therefore e = -\left(-L \frac{di}{dt}\right) = L \frac{di}{dt} \text{ (from Eq. (13.6))}$$

$$\therefore di = \frac{e}{L} dt$$

Integrating the above equation on both the sides, we get,

$$\int di = \int \frac{e}{L} dt$$

$$i = \int \frac{e_0 \sin \omega t}{L} dt \quad (\because e = e_0 \sin \omega t)$$

$$i = \frac{e_0}{L} \left[\frac{-\cos \omega t}{\omega} \right] + \text{constant}$$

Constant of integration is time independent and has the dimensions of i . As the emf oscillates about zero, i also oscillates about zero so that there cannot be any component of current which is time independent.

Thus, the integration constant is zero

$$\therefore i = \frac{-e_0}{\omega L} \sin\left(\frac{\pi}{2} - \omega t\right) \quad \left(\because \sin\left(\frac{\pi}{2} - \omega t\right) = \cos \omega t \right)$$

$$\therefore i = \frac{e_0}{\omega L} \sin\left[\omega t - \frac{\pi}{2}\right]$$

$$i = i_0 \sin\left[\omega t - \frac{\pi}{2}\right] \quad \text{--- (13.7)}$$

where $i_0 = \frac{e_0}{\omega L}$ --- (13.8)

where i_0 is the peak value of current. Eq. (13.7) gives the alternating current developed in a purely inductive circuit when connected to a source of alternating emf.

Comparing Eq. (13.5) and (13.7) we find that the alternating current i lags behind the alternating voltage emf e by a phase angle of

$\pi/2$ radians (90°) or the voltage across L leads the current by a phase angle of $\pi/2$ radians (90°) as shown in Fig. 13.7.

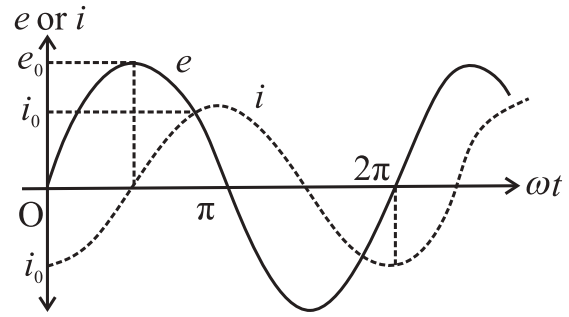

Fig 13.7: Graph of e and i versus ωt .

Phasor diagram:

The phasor representing peak emf e_0 makes an angle ωt in anticlockwise direction from horizontal axis. As current lags behind the voltage by 90° , so the phasor representing i_0 is turned clockwise with the direction of e_0 as shown in Fig. 13.8.

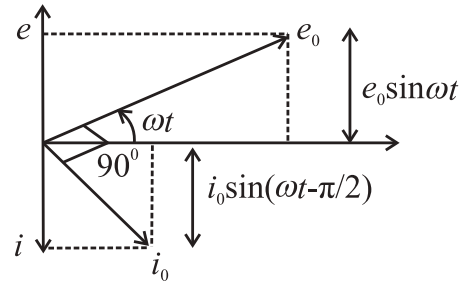

Fig. 13.8 Phasor diagram for purely inductive.

Inductive Reactance (X_L):

The opposing nature of inductor to the flow of alternating current is called inductive reactance.

Comparing Eq (13.8) with Ohm's law, $i_0 = \frac{e_0}{R}$ we find that ωL represents the effective resistance offered by the inductance L , it is called the inductive reactance and denoted by X_L .

$$\therefore X_L = \omega L = 2\pi fL. \quad (\because \omega = 2\pi/T = 2\pi f)$$

where f is the frequency of the AC supply.

The function of the inductive reactance is similar to that of the resistance in a purely resistive circuit. It is directly proportional to the inductance (L) and the frequency (f) of the alternating current.

The dimensions of inductive reactance is the same as those of resistance and its SI unit is ohm (Ω).

In DC circuits $f = 0 \therefore X_L = 0$

It implies that a pure inductor offers zero resistance to DC, i.e., it cannot reduce DC. Thus, it passes DC and blocks AC of very high frequency.

In an inductive circuit, the self induced emf opposes the growth as well as decay of current.

Example 13.3: An inductor of inductance 200 mH is connected to an AC source of peak emf 210 V and frequency 50 Hz. Calculate the peak current. What is the instantaneous voltage of the source when the current is at its peak value?

Solution: Given

$$L = 200 \text{ mH} = 0.2 \text{ H}$$

$$e_0 = 210 \text{ V}$$

$$f = 50 \text{ Hz}$$

$$\begin{aligned} \text{Peak Current } i_0 &= \frac{e_0}{X_L} = \frac{e_0}{2\pi fL} \\ &= \frac{210}{2 \times 3.142 \times 50 \times 0.2} \\ \therefore i_0 &= 3.342 \text{ A} \end{aligned}$$

As in an inductive AC circuit, current lags behind the emf by $\frac{\pi}{2}$, so the voltage is zero when the current is at its peak value.

c) AC voltage applied to a capacitor:

Let us consider a capacitor with capacitance C connected to an AC source with an emf having instantaneous value

$$e = e_0 \sin \omega t \quad \text{--- (13.9)}$$

This is shown in Fig. 13.9

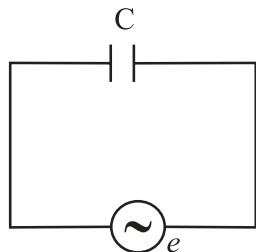

Fig: 13.9 An AC source connected to a capacitor.

The current flowing in the circuit transfers charge to the plates of the capacitor which produces a potential difference between the plates. As the current reverses its direction in each half cycle, the capacitor is alternately charged and discharged.

Suppose q is the charge on the capacitor at any given instant t . The potential difference across the plates of the capacitor is

$$V = \frac{q}{C} \text{ or } q = CV \quad \text{--- (13.10)}$$

The instantaneous value of current (i) in the circuit is

$$\begin{aligned} i &= \frac{dq}{dt} = \frac{d}{dt}(Ce) \quad (\because V = e \text{ at every instant}) \\ &= \frac{d}{dt}(Ce_0 \sin \omega t) \quad (\because e = e_0 \sin \omega t) \\ &= Ce_0 \cos \omega t \cdot \omega \\ &= \frac{e_0}{1/\omega C} \cos \omega t \end{aligned}$$

$$\therefore i = \frac{e_0}{1/\omega C} \sin \left(\omega t + \frac{\pi}{2} \right) \left(\because \cos \omega t = \sin \left(\frac{\pi}{2} + \omega t \right) \right) \quad \text{--- (13.11)}$$

The current will be maximum when $\sin(\omega t + \pi/2) = 1$, so that $i = i_0$ where, peak value of current is

$$i_0 = \frac{e_0}{1/\omega C} \quad \text{--- (13.12)}$$

$$\therefore i = i_0 \sin \left(\omega t + \frac{\pi}{2} \right) \quad \text{--- (13.13)}$$

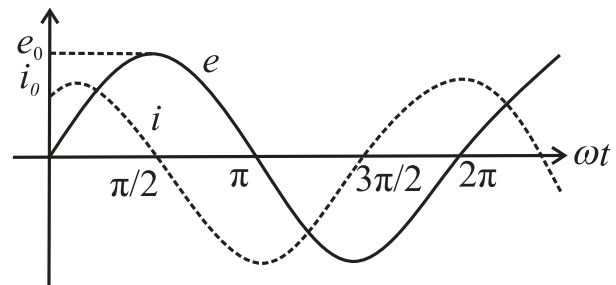

Fig. 13.10 Graph of e and i versus ωt .

From Eq. (13.9) and Eq. (13.13) we find that in an AC circuit containing a capacitor only, the alternating current i leads the alternating emf e by phase angle of $\pi/2$ radian as shown in Fig. 13.10.

Phasor diagram:

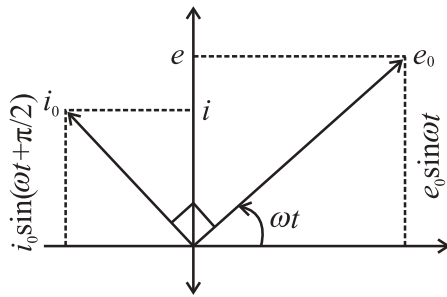

Fig.13.11: Phasor diagram for purely capacitive circuit.

The phasor representing peak emf makes an angle ωt in anticlockwise direction with respect to horizontal axis. As current leads the voltage by 90° , the phasor representing i_0 current is turned 90° anticlockwise with respect to the phasor representing emf e_0 . The projections of these phasors on the vertical axis gives instantaneous values of e and i .

Capacitive Reactance: The instantaneous value of alternating current through a capacitor is given by

$$i = \frac{e_0}{(1/\omega C)} \sin\left(\omega t + \frac{\pi}{2}\right)$$

$$= i_0 \sin\left(\omega t + \frac{\pi}{2}\right)$$

Comparing Eq. (13.12) with Ohm's law, $i_0 = \frac{e_0}{R}$ we find that $(1/\omega C)$ represents effective resistance offered by the capacitor called the capacitive reactance denoted by X_C .

$\therefore X_C = \frac{1}{\omega C} = \frac{1}{2\pi fC}$ where f is the frequency of AC supply.

The function of capacitive reactance in a purely capacitive circuit is to limit the amplitude of the current similar to the resistance in a purely resistive circuit.

X_C varies inversely as the frequency of AC and also as the capacitance of the condenser.

In a DC circuit, $f = 0 \therefore X_C = \infty$

Thus, capacitor blocks DC and acts as open circuit while it passes AC of high frequency.

The dimensions of capacitive reactance

are the same as that of resistance and its SI unit is ohm (Ω).

Table 13.1: Comparison between resistance and reactance.

Resistance	Reactance
Equally effective for AC and DC	Current is affected (reduced) but energy is not consumed (heat is not generated). The energy consumption by a coil is due to its resistive component.
Its value is independent of frequency of the AC	Inductive reactance ($X_L = 2\pi fL$) is directly proportional and capacitive reactance ($X_C = \frac{1}{2\pi fC}$) is inversely proportional to the frequency of the AC.
Current opposed by a resistor is in phase with the voltage.	Current opposed by a pure inductor lags in phase while that opposed by a pure capacitor leads in phase by π^c over the voltage.

Example 13.4: 4. A Capacitor of $2 \mu\text{F}$ is connected to an AC source of emf $e = 250 \sin 100\pi t$. Write an equation for instantaneous current through the circuit and give reading of AC ammeter connected in the circuit.

Solution: Given

$$C = 2\mu\text{F} = 2 \times 10^{-6} \text{ F}$$

$$e_0 = 250 \text{ V}$$

$$\omega = 100\pi \text{ rad/sec}$$

The instantaneous current through the circuit

$$i = i_0 \sin\left(\omega t + \frac{\pi}{2}\right)$$

$$= \omega C e_0 \sin\left(\omega t + \frac{\pi}{2}\right)$$

$$= 3.142 \times 2 \times 10^{-4} \times 250 \sin\left(100\pi t + \frac{\pi}{2}\right)$$

$$= 0.1571 \sin \left(100\pi t + \frac{\pi}{2} \right)$$

Reading of the AC ammeter is

$$i_{\text{rms}} = 0.707 i_0$$

$$= 0.707 \times 0.1571$$

$$i_{\text{ms}} = 0.111\text{A}$$

(d) AC circuit containing resistance inductance and capacitance in series (LCR circuit):

Above we have studied the opposition offered by a resistor, pure inductor and capacitor to the flow of AC current independently.

Now let us consider the total opposition offered by a resistor, pure inductor and capacitor connected in series with the alternating source of emf as shown in Fig. 13.12.

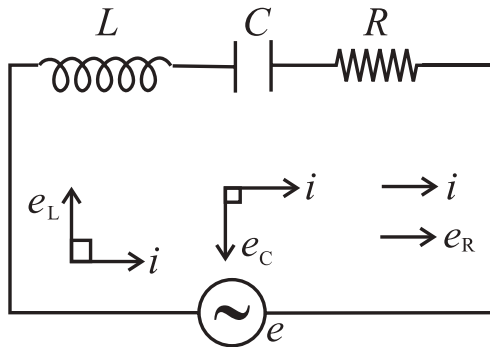

Fig. 13.12: Series LCR circuit.

Let a pure resistor R , a pure inductance L and an ideal capacitor of capacitance C be connected in series to a source of alternative emf. As R , L and C are in series, the current at any instant through the three elements has the same amplitude and phase. Let it be represented by

$$i = i_0 \sin \omega t.$$

The voltage across each element bears a different phase relationship with the current. The voltages e_L , e_C and e_R are given by

$$e_R = iR, e_L = iX_L \text{ and } e_C = iX_C$$

As the voltage across the capacitor lags behind the alternating current by 90° , it is represented by \overline{OC} , rotated clockwise through 90° from the direction of \vec{i}_0 . \overline{OC} is along OY' in the phasor diagram shown in the phasor diagrams in Fig. 13.13.

As e_R is in phase with current i_0 the vector e_R is drawn in the same direction as that of i , along the positive direction of X -axis represented by \overline{OA} . The voltage across L and C have a phase different of 180° hence the net reactive voltage is $(e_L - e_C)$.

Assuming $e_L > e_C$ represented by OB' in the figure.

The resultant of \overline{OA} and $\overline{OB'}$ is the diagonal OK of the rectangle $OAKB'$

$$\therefore OK = \sqrt{OA^2 + OB'^2}$$

$$e_0 = \sqrt{e_R^2 + (e_L - e_C)^2}$$

$$= \sqrt{(i_0 R)^2 + (i_0 X_L - i_0 X_C)^2}$$

$$e_0 = i_0 \sqrt{R^2 + (X_L - X_C)^2}$$

$$\therefore \frac{e_0}{i_0} = \sqrt{R^2 + (X_L - X_C)^2}$$

$$\frac{e_0}{i_0} = Z$$

Comparing the above equation with the relation $\frac{V}{i} = R$, the quantity $\sqrt{R^2 + (X_L - X_C)^2}$ represents the effective opposition offered by the inductor, capacitor and resistor connected in series to the flow of AC current. This total effective resistance of LCR circuit is called the impedance of the circuit and is represented by Z . The reciprocal of impedance of an AC circuit is called admittance. Its SI unit is ohm^{-1} or siemens.

It can be defined as the ratio of rms voltage to the rms value of current Impedance is expressed in ohm (Ω).

Phasor diagram:

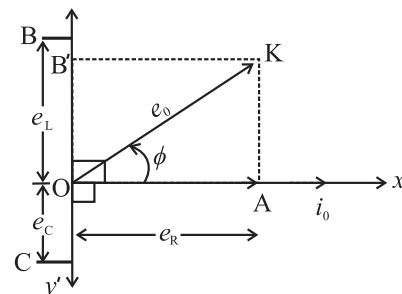

Fig. 13.13: Phasor diagram for an LCR circuit.

From the phasor diagram (Fig. 13.13) it can be seen that in an AC circuit containing L, C and R, the voltage leads the current by a phase angle ϕ ,

$$\tan \phi = \frac{AK}{OA} = \frac{OB'}{OA} = \frac{e_L - e_C}{e_R} = \frac{i_o X_L - i_o X_C}{i_o R}$$

$$\tan \phi = \frac{X_L - X_C}{R} \therefore \phi = \tan^{-1} \left(\frac{X_L - X_C}{R} \right)$$

\therefore The alternating current in LCR circuit would be represented by

$$i = i_o \sin (\omega t + \phi)$$

$$\text{and } e = e_o \sin (\omega t + \phi)$$

We can now discuss three cases based on the above discussion.

(i) When $X_L = X_C$ then $\tan \phi = 0$.

Hence voltage and current are in phase. Thus the AC circuit is non inductive.

(ii) When $X_L > X_C$, $\tan \phi$ is positive $\therefore \phi$ is positive.

Hence voltage leads the current by a phase angle ϕ . The AC circuit is inductance dominated circuit.

(iii) When $X_L < X_C$, $\tan \phi$ is negative $\therefore \phi$ is negative.

Hence voltage leads the current by a phase angle ϕ . The AC circuit is capacitance dominated circuit.

Impedance triangle:

From the three phasors

$$\vec{e}_R = i_o R, \vec{e}_L = i_o X_L, \vec{e}_C = i_o X_C$$

we obtain the impedance triangle as shown in Fig 13.14.

Fig. 13.14: Impedance triangle.

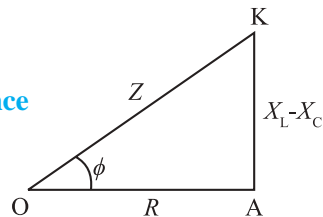

The diagonal OK represents the impedance Z of the AC circuit.

$Z = \sqrt{R^2 + (X_L - X_C)^2}$, the base OA represents the Ohmic resistance R and the perpendicular AK represents reactance $(X_L - X_C)$. $\angle AOK = \phi$, is the phase angle by which the voltage leads the current in the circuit, where $\tan \phi = \frac{X_L - X_C}{R}$

Example 13.5: A 100mH inductor, a 25 μ F capacitor and a 15 Ω resistor are connected in series to a 120 V, 50 Hz AC source. Calculate

- (i) impedance of the circuit at resonance
- (ii) current at resonance
- (iii) Resonant frequency

Solution: Given

$$L = 100 \text{ mH} = 10^{-1} \text{ H}$$

$$C = 25 \mu\text{F} = 25 \times 10^{-6} \text{ F}$$

$$R = 15 \Omega$$

$$e_{\text{rms}} = 120 \text{ V}$$

$$f = 50 \text{ Hz}$$

(i) At resonance, $Z = R = 15 \Omega$

$$(ii) i_{\text{rms}} = \frac{e_{\text{rms}}}{R} = \frac{120}{15} = 8 \text{ A}$$

$$(iii) f = \frac{1}{2\pi\sqrt{LC}} = \frac{1}{2 \times 3.142 \sqrt{10^{-1} \times 25 \times 10^{-6}}} \\ = \frac{1}{9.9356 \times 10^{-3}} \\ \therefore f = 100.65 \text{ Hz}$$

Example 13.6: A coil of 0.01H inductance and 1 Ω resistance is connected to 200V, 50Hz AC supply. Find the impedance of the circuit and time lag between maximum alternating voltage and current.

Solution: Given

$$\text{Inductance } L = 0.01 \text{ H}$$

$$\text{Resistance } R = 1 \Omega$$

$$e_o = 200 \text{ V}$$

$$\text{Frequency } f = 50 \text{ Hz}$$

$$\text{Impedance of the circuit } Z = \sqrt{R^2 + X_L^2}$$

$$= \sqrt{R^2 + (2\pi fL)^2}$$

$$= \sqrt{(1)^2 + (2 \times 3.142 \times 50 \times 0.01)^2}$$

$$= \sqrt{10.872} = 3.297 \Omega$$

$$\tan \phi = \frac{\omega L}{R} = \frac{2\pi fL}{R} = \frac{2 \times 3.142 \times 50 \times 0.01}{1} \\ = 3.142$$

$$\phi = \tan^{-1}(3.142) = 72.35^\circ$$

$$\text{Phase difference, } \phi = \frac{72.35 \times \pi}{180} \text{ rad}$$

Time lag between maximum alternating voltage and current

$$\Delta t = \frac{\phi}{\omega} = \frac{72.35 \times \pi}{180 \times 2\pi \times 50} = 0.004 \text{ s}$$

13.6 Power in AC circuit:

We know that power is defined as the rate of doing work. For a DC circuit, power is measured as a product of voltage and current. But since in an AC circuit the values of current and voltage change at every instant the power in an AC circuit at a given instant is the product of instantaneous voltage and instantaneous current.

a) Average power associated with resistance (power in AC circuit with resistance).

In a pure resistor, the alternating current developed is in phase with the alternating voltage applied i.e. when $e = e_0 \sin \omega t$

$$\text{then } i = i_0 \sin \omega t$$

Now instantaneous power $P = ei$.

$$P = (e_0 \sin \omega t) (i_0 \sin \omega t) \\ = e_0 i_0 \sin^2 \omega t \quad \text{--- (13.14)}$$

The instantaneous power varies with time, hence we consider the average power for a complete cycle by integrating Eq. (13.14).

$$\begin{aligned} \therefore P_{av} &= \frac{\text{work done by the emf on the charges in one cycle}}{\text{time for one cycle}} \\ &= \frac{\int_0^T P dt}{T} = \frac{\int_0^T e_0 i_0 \sin^2 \omega t dt}{T} \\ &= \frac{e_0 i_0}{T} \int_0^T \sin^2 \omega t dt \\ &= \frac{e_0 i_0}{T} \left(\frac{T}{2} \right) \left[\because \int_0^T \sin^2 \omega t dt = \frac{T}{2} \right] \\ &= \frac{e_0}{\sqrt{2}} \frac{i_0}{\sqrt{2}} \therefore P = P_{av} = e_{rms} \times i_{rms} \quad \text{--- (13.15)} \end{aligned}$$

P is also called as apparent power.

Example 13.7: A 100Ω resistor is connected to a 220V, 50Hz supply

- What is the rms value current in the circuit?
- What is the net power consumed over a full cycle?

Solution: Given

$$R = 100\Omega, e_{rms} = 220V, f = 50 \text{ Hz}$$

$$(i) i_{rms} = \frac{e_{rms}}{R} = \frac{220}{100} = 2.2A$$

(ii) Net Power Consumed

$$P_{av} = e_{rms} \cdot i_{rms} \\ = 220 \times 2.2 = 484 \text{ W}$$

b) Average power associated with an inductor:

In an purely inductive circuit, the current lags behind the voltage by a phase angle of $\pi/2$. i.e., when $e = e_0 \sin \omega t$ then

$$i = i_0 \sin (\omega t - \pi/2).$$

Now, instantaneous power $P = ei$

$$P = (e_0 \sin \omega t) (i_0 \sin (\omega t - \pi/2))$$

$$= - e_0 i_0 \sin \omega t \cos \omega t$$

$$= - e_0 i_0 \sin \omega t \cos \omega t$$

$$\therefore P_{av} = \frac{\text{work done in one cycle}}{\text{time for one cycle}}$$

$$= \frac{\int_0^T P dt}{T} = \frac{\int_0^T -e_0 i_0 \sin \omega t \cos \omega t dt}{T}$$

$$= \frac{\frac{e_0 i_0}{2} \int_0^T 2 \sin \omega t \cos \omega t dt}{T}$$

$$= - \frac{e_0 i_0}{2} \int_0^T \sin 2\omega t dt$$

$$= - \frac{e_0 i_0}{2T} \left[\left(- \frac{\cos 2\omega t}{2\omega} \right) \right]_0^T$$

$$P_{av} = 0$$

\therefore average power over a complete cycle of AC through an ideal inductor is zero.

c) Average power associated with a capacitor:

In a purely capacitive circuit the current leads the emf by a phase angle of $\pi/2$ i.e. when $e = e_0 \sin \omega t$ then $i = i_0 \sin (\omega t + \pi/2)$

$$i = i_0 \cos \omega t$$

Now, instantaneous power $P = ei$

$$= (e_0 \sin \omega t) (i_0 \cos \omega t)$$

$$= e_0 i_0 \sin \omega t \cos \omega t.$$

$$\therefore P_{av} = \frac{\text{work done in one cycle}}{\text{time for one cycle}}$$

$$P_{av} = \frac{\int_0^T P dt}{T} = \frac{\int_0^T e_0 i_0 \sin \omega t \cos \omega t}{T}$$

$$P_{av} = 0 \text{ (as shown above)}$$

Average power supplied to an ideal capacitor by the source over a complete cycle of AC is also zero.

d) Average power in LCR Circuit:

Let $e = e_0 \sin \omega t$ be the alternating emf applied across the series combination of pure inductor, capacitor and resistor as shown in Fig. 13.16.

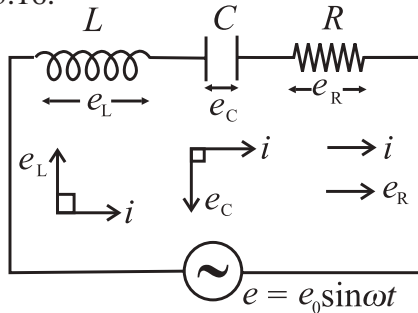

Fig. 13.15: LCR series circuit.

There is a phase difference ϕ between the applied emf and current given by

$$i = i_0 \sin (\omega t \pm \phi)$$

Instantaneous power is given by

$$P = ei$$

$$= (e_0 \sin \omega t) i_0 \sin (\omega t \pm \phi)$$

$$= e_0 i_0 [\sin \omega t \cos \phi \pm \cos \omega t \sin \phi] \sin \omega t$$

$$= e_0 i_0 [\sin^2 \omega t \cos \phi \pm \cos \omega t \sin \phi \sin \omega t]$$

\therefore Average power

$$P_{av} = \frac{\text{work done in one cycle}}{\text{time for one cycle}}$$

$$= \frac{\int_0^T P dt}{T}$$

$$= \frac{\int_0^T e_0 i_0 [\sin^2 \omega t \cos \phi \pm \cos \omega t \sin \omega t \sin \phi] dt}{T}$$

$$= \frac{e_0 i_0}{T} \left[\cos \phi \int_0^T \sin^2 \omega t dt \right] \pm \left(\sin \phi \int_0^T \cos \omega t \sin \omega t dt \right)$$

--- (13.16)

As seen above,

$$= \int_0^T \sin^2 \omega t dt = T / 2$$

--- (13.17)

$$\text{and } \int_0^T \cos \omega t \sin \omega t dt = 0$$

substituting (13.17) in (13.16)

$$P_{av} = \frac{e_0 i_0}{T} \left[\left(\cos \phi \cdot \frac{T}{2} \right) \pm (\sin \phi (0)) \right]$$

$$= \frac{e_0 i_0}{T} \cdot \cos \phi \cdot \frac{T}{2}$$

$$P_{av} = e_{rms} i_{rms} \cos \phi \quad \text{--- (13.18)}$$

This power (P_{av}) is also called as true power. The average power dissipated in the AC circuit of inductor, capacitor and resistor connected in series not only depends on rms values of current and emf but also on the phase difference ϕ between them.

The factor $\cos \phi$ is called as power factor

$$\therefore \text{Power factor } (\cos \phi) = \frac{\text{true power } (P)}{\text{apparent power } P_{av}}$$

$$= \frac{R}{\sqrt{R^2 + (X_L - X_C)^2}} \left[\begin{array}{l} \text{from} \\ \text{impedance} \\ \text{triangle} \end{array} \right]$$

$$\therefore \text{Power factor } \cos \phi = \frac{R}{Z} = \frac{\text{resistance}}{\text{impedance}}$$

In a non inductive circuit $X_L = X_C$

$$\therefore \text{Power factor } (\cos \phi) = \frac{R}{\sqrt{R^2}}$$

$$= \frac{R}{R} = 1 \therefore \phi = 0$$

In a purely inductive and capacitive circuit; $\phi = 90^\circ$

$$\therefore \text{Power factor} = 0$$

Average power consumed in a pure inductor or ideal capacitor $P_{av} = e_{rms} i_{rms} \cos 90^\circ = \text{zero}$.

\therefore Current through pure inductor or ideal capacitor which consumes no power for its maintenance, in the circuit is called idle current or wattless current. Power dissipated in a circuit is due to resistance only.

Example 13.8: A sinusoidal voltage of peak value 283 V and frequency 50 Hz is applied to a series LCR circuit in which $R = 3\Omega$, $L = 25.48 \text{ mH}$ and $C = 796 \mu\text{f}$. Find

- i) The impedance of the circuit
- ii) The phase difference between the voltage across source and the currents
- iii) The power factor
- iv) The power dissipated in the surface

Solution: Given

$$e_0 = 283 \text{ V}, f = 50 \text{ Hz}, R = 3\Omega,$$

$$L = 25.48 \times 10^{-3} \text{ H}, C = 796 \times 10^{-6} \text{ F}$$

$$X_L = 2\pi fL = 2 \times 3.142 \times 50 \times 25.48 \times 10^{-3} = 8\Omega$$

$$X_C = \frac{1}{2\pi fL} = \frac{1}{2 \times 3.142 \times 50 \times 796 \times 10^{-6}} = \frac{1}{0.2501} = 4\Omega$$

$$\text{Therefore } Z = \sqrt{R^2 + (X_L - X_C)^2} = \sqrt{3^2 + (8 - 4)^2} = 5 \Omega$$

Phase difference ϕ is given by

$$\tan \phi = \frac{X_L - X_C}{R} = \frac{8 - 4}{3} = \frac{4}{3}$$

$$\text{Therefore, } \phi = \tan^{-1}\left(\frac{4}{3}\right) = 53.1^\circ$$

Thus the current lags behind the voltage across the source by a phase angle of 53.1°

$$\text{Power factor} = \cos \phi = 0.6$$

Power dissipated in the circuit

$$\begin{aligned} P_{\text{av}} &= e_{\text{rms}} i_{\text{rms}} \cos \phi \\ &= \frac{e_0}{\sqrt{2}} \frac{e_0}{\sqrt{2}R} (0.6) \\ &= \frac{283}{\sqrt{2}} \frac{283}{\sqrt{2} \times 3} 0.6 \\ &= 8008.9 \text{ W} \end{aligned}$$

13.7 LC Oscillations:

We have seen in chapters 8,10 and 12 that capacitors and inductors store energy in their electric and magnetic fields respectively. When a capacitor is supplied with an AC current it gets charged. When such a fully

charged capacitor is connected to an inductor, the charge is transferred to the inductor and current starts flowing through the inductor. Because of the increasing current there will be a change in the magnetic flux of the inductor in the circuit. Hence induced emf is produced in the circuit. This self-induced emf will try to oppose the growth of the current. Due to this the charge (energy stored in) on the capacitor decreases and an equivalent amount of energy is stored in the inductor in the form of magnetic field. When the discharging of the capacitor completes, all the energy stored in the capacitor will be stored in the inductor. The capacitor will become fully discharged whereas inductor will be storing all the energy. As a result now the inductor will start charging the capacitor. The current and magnetic flux linked with the inductor starts decreasing. Therefore an induced emf is produced which recharges the capacitor in the opposite direction. This process of charging and discharging of capacitor is repeated and energy taken from the source keeps on oscillating between the capacitor (C) and the inductor (L).

When a charged capacitor is allowed to discharge through a non-resistive inductor, electrical oscillations of constant amplitude and frequency are produced. These oscillations are called LC oscillations. This is explained in Fig. 13.16.

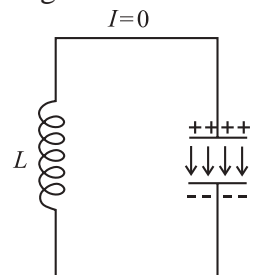

Fig. 13.16 (a) Let a capacitor with initial charge q_0 at $(t = 0)$ be connected to an ideal inductor (zero resistance). The

electrical energy stored in the dielectric medium between the plates of the capacitor is $U_E = \frac{1}{2} \frac{q_0^2}{C}$. Since there is no current in the circuit the energy stored in the magnetic field of the inductor is zero.

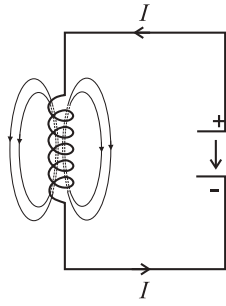

Fig. 13.16 (b) As the circuit is closed, the capacitor begins to discharge itself through the inductor giving rise to a current (I) in the circuit. As the current (I)

increases, it builds up a magnetic field around the inductor. A part of the electrical energy of the capacitor gets stored in the inductor in the form of magnetic energy $U_B = \frac{1}{2} LI^2$

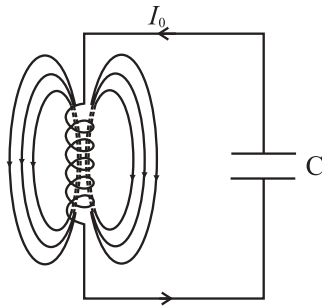

Fig. 13.16 (c) At a later instant the capacitor gets fully discharged and the potential difference across its plates becomes zero. The current reaches its maximum value I_0 , the energy in the magnetic field is energy $\frac{1}{2} LI_0^2$. Thus the entire electrostatic energy of the capacitor has been converted into the magnetic field energy of the inductor.

zero. The current reaches its maximum value I_0 , the energy in the magnetic field is energy $\frac{1}{2} LI_0^2$. Thus the entire electrostatic energy of the capacitor has been converted into the magnetic field energy of the inductor.

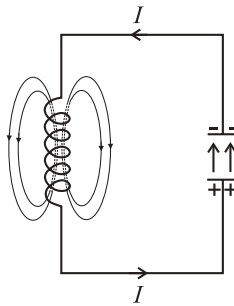
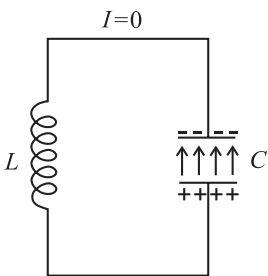

Fig. 13.16 (d) After the discharge of the capacitor is complete, the magnetic flux linked with the inductor decreases inducing a current in the same direction (Lenz's Law) as the earlier current. The current thus persists but with decreasing magnitude and charges the capacitor in the opposite direction. The magnetic energy of the inductor begins to change into the electrostatic energy of the capacitor.

After the discharge of the capacitor is complete, the magnetic flux linked with the inductor decreases inducing a current in the same direction (Lenz's Law) as the earlier current. The current thus persists but with decreasing magnitude and charges the capacitor in the opposite direction. The magnetic energy of the inductor begins to change into the electrostatic energy of the capacitor.

Fig. 13.16 (e) The process continues till the capacitor is fully charged with a polarity which is opposite to that in its initial state. Thus the



entire energy is again stored as $\frac{1}{2} \frac{q_0^2}{k}$ in the electric field of the capacitor.

The capacitor begins to discharge again sending current in opposite direction. The energy is once again transferred to the magnetic field of the inductor. Thus the process repeats itself in the opposite direction.

The circuit eventually returns to the initial state.

Thus the energy of the system continuously surges back and forth between the electric field of the capacitor and magnetic field of the inductor. This produces electrical oscillations of a definite frequency. These are called LC Oscillations. If there is no loss of energy the amplitude of the oscillations remain constant and the oscillations are undamped.

However LC oscillations are usually damped due to following reasons.

1. Every inductor has some resistance. This causes energy loss as heat. The amplitude of oscillations goes on decreasing and they finally die out.
2. Even if the resistance were zero, total energy of the system would not remain constant. It is radiated away in the form of electromagnetic waves. Working of radio and TV transmitters is based on such radiations.

13.8 Electric Resonance:

Have you ever wondered how radio picks certain frequencies so you can play your favourite channel or why does a glass break down in an orchestra concert? Why do you think you encounter such situations? The answer lies in the phenomenon of resonance. The phenomenon of resonance can be observed in systems that have a tendency to oscillate at a particular frequency, which is called the natural frequency of oscillation of the system. When such a system is driven by an energy source, whose frequency is equal to the natural frequency of the system, the amplitude

of oscillations become large and resonance is said to occur.

(a) Series resonance circuit:

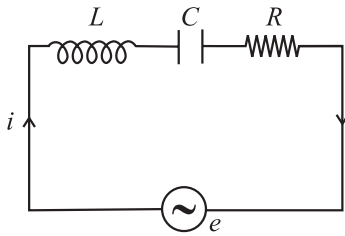

Fig. 13.17: Series resonance circuit.

A circuit in which inductance L , capacitance C and resistance R are connected in series (Fig. 13.17), and the circuit admits maximum current corresponding to a given frequency of AC, is called a series resonance circuit.

The impedance (Z) of an LCR circuit is given by

$$Z = \sqrt{R^2 + \left(\omega L - \frac{1}{\omega C}\right)^2}$$

At very low frequencies, inductive reactance $X_L = \omega L$ is negligible but capacitive reactance $X_C = \frac{1}{\omega C}$ is very high.

As we increase the applied frequency then X_L increases and X_C decreases.

At some angular frequency (ω_r), $X_L = X_C$

i.e. $\omega_r L = \frac{1}{\omega_r C}$

$$\therefore (\omega_r)^2 = \frac{1}{LC} \quad \text{or} \quad (2\pi f_r)^2 = \frac{1}{LC}$$

$$\therefore 2\pi f_r = \frac{1}{\sqrt{LC}}$$

$$\therefore f_r = \frac{1}{2\sqrt{LC}}$$

Where f_r is called the resonant frequency.

At this particular frequency f_r , since $X_L = X_C$ we get $Z = \sqrt{R^2 + 0} = R$. This is the least value of Z . Thus, when the impedance of an LCR circuit is minimum, circuit is said to be purely resistive, current and voltage are in phase and hence the current $i_o = \frac{e_o}{Z} = \frac{e_o}{R}$ is maximum.

This condition of the LCR circuit is called **resonance condition** and this frequency is called **series resonant frequency**.

At $\omega = \omega_r$, value of peak current (i_o) is maximum. The maximum value of peak current is inversely proportional to R ($\because i_o = \frac{e_o}{R}$). For lower R values, i_o is large and vice versa. The variation of rms current with frequency of AC is as shown in graph 13.18. The curve is called the series resonance curve. At resonance rms current becomes maximum. This circuit at resonant condition is very useful for radio and TV receivers for tuning the signal from a desired transmitting station or channel.

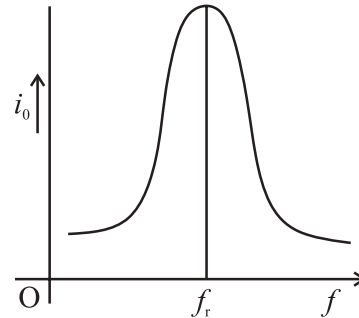

Fig. 13.18: Series resonance curve.

Characteristics of series resonance circuit

- 1) Resonance occurs when $X_L = X_C$
- 2) Resonant frequency $f_r = \frac{1}{2\pi\sqrt{LC}}$
- 3) Impedance is minimum and circuit is purely resistive.
- 4) Current has a maximum value.
- 5) When a number of frequencies are fed to it, it accepts only one frequency (f_r) and rejects the other frequencies. The current is maximum for this frequency. Hence it is called **acceptor circuit**.

b) Parallel resonance circuit:

A parallel resonance circuit consists of a coil of inductance L and a condenser of capacity C joined in parallel to a source of alternating emf. as shown in Fig. 13.19.

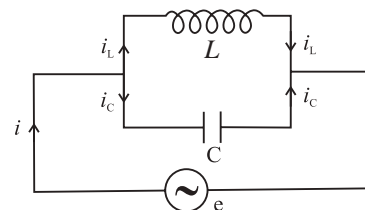

Fig. 13.19 : Parallel resonance circuit.

Let the alternating emf supplied by the source be

$$e = e_o \sin \omega t$$

In case of an inductor, the current lags behind the applied emf by a phase angle of $\pi/2$, then the instantaneous current through L is given by

$$i_L = \frac{e_0}{X_L} \sin(\omega t - \pi/2)$$

Similarly in a capacitor, as current leads the emf by a phase angle of $\pi/2$, we can write

$$i_c = \frac{e_0}{X_C} \sin(\omega t + \pi/2)$$

\therefore The total current i in the circuit at this instant is

$$\begin{aligned} i &= i_c + i_L \\ &= \frac{e_0}{X_L} \sin(\omega t - \pi/2) + \frac{e_0}{X_C} \sin(\omega t + \pi/2) \\ &= \frac{e_0}{X_L} (-\cos \omega t) + \frac{e_0}{X_C} \cos \omega t \\ &= e_0 \cos \omega t \left(\frac{1}{X_C} - \frac{1}{X_L} \right) \\ i &= e_0 \cos \omega t \left(\omega C - \frac{1}{\omega L} \right) \end{aligned}$$

We find that,

$$i = \text{minimum when } \omega C - \frac{1}{\omega L} = 0$$

$$\text{i.e. } \omega C = \frac{1}{\omega L} \text{ i.e. } \omega^2 = \frac{1}{LC}$$

$$\therefore \omega = \frac{1}{\sqrt{LC}} \text{ or } 2\pi f_r = \frac{1}{\sqrt{LC}}$$

$$\therefore f_r = \frac{1}{2\pi\sqrt{LC}}$$

Where f_r is called the resonant frequency.

Therefore at parallel resonance frequency f_r , $i = \text{minimum}$ i.e. the circuit allows minimum current to flow through it. (as shown in the graph 13.20). Impedance is maximum at this frequency. The circuit is called parallel resonance circuit. A parallel resonant circuit is very useful in wireless transmission or radio communication and filter circuits.

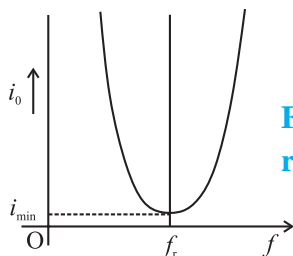

Fig. 13.20: Parallel resonant curve.

Characteristics of parallel resonance circuit

1. Resonance occurs when $X_L = X_C$.
2. Resonant frequency $f_r = \frac{1}{2\sqrt{LC}}$
3. Impedance is maximum
4. Current is minimum.
5. When alternating current of different frequencies are sent through parallel resonant circuit, it offers a very high impedance to the current of the resonant frequency (f_r) and rejects it but allows the current of the other frequencies to pass through it, hence called a **rejector circuit**.



Do you know?

Resonance occurs in a series LCR circuit when $X_L = X_C$ or $\omega = \frac{1}{\sqrt{LC}}$. For resonance to occur, the presence of both L and C elements in the circuit is essential. Only then the voltages L and C (being 180° out of phase) will cancel each other and current amplitude will be e_0/R i.e., the total source voltage will appear across. So we cannot have resonance LR and CR circuit.

13.9 Sharpness of Resonance: Q factor

We have seen in section 13.4 (d) that the amplitude of current in the series LCR circuit is given by

$$i_0 = \frac{e_0}{\sqrt{R^2 + (\omega L - \frac{1}{\omega C})^2}}$$

Also if ω is varied, then at a particular frequency $\omega = \omega_r$, $X_L = X_C$ i.e. $\omega_r L = \frac{1}{\omega_r C}$. For a given resistance R , the amplitude of current is maximum when $\omega_r L - \frac{1}{\omega_r C} = 0$

$$\therefore \omega_r = \frac{1}{\sqrt{LC}}$$

For values of ω other than ω_r , the amplitude of the current is less than the maximum value i_0 .

Suppose we choose a value for ω for which the amplitude is $\frac{1}{\sqrt{2}}$ times its maximum value, the power dissipated by the circuit becomes half (called half power frequency).

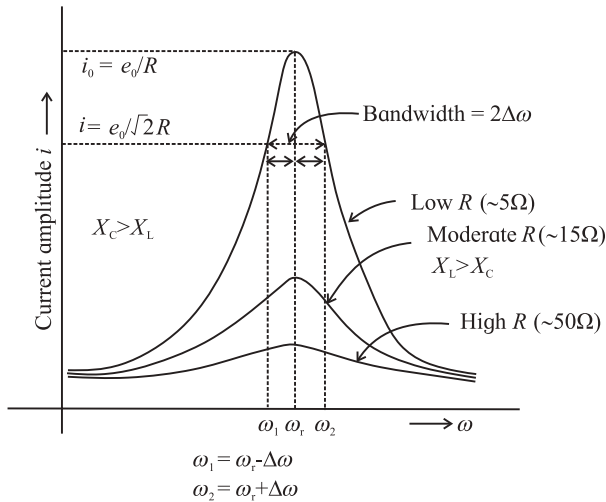

Fig. 13.21: Sharpness resonance.

From the curve in the Fig. (13.21) we see that there are two such values of ω say ω_1 and ω_2 , one greater and other smaller than ω_r and symmetrical about ω_r such that

$$\omega_1 = \omega_r - \Delta\omega$$

$$\omega_2 = \omega_r + \Delta\omega$$

The difference $\omega_2 - \omega_1 = 2\Delta\omega$ is called the bandwidth of the circuit. The quantity $(\frac{\omega_r}{2\Delta\omega})$ is regarded as the measure of the sharpness of resonance. The sharpness of resonance is measured by a coefficient called the quality or Q factor of the circuit

The Q factor of a series resonant circuit is defined as the ratio of the resonant frequency to the difference in two frequencies taken on both sides of the resonant frequency such that at each frequency the current amplitude becomes $\frac{1}{\sqrt{2}}$ times the value at resonant frequency.

$$\therefore Q = \frac{\omega_r}{\omega_2 - \omega_1} = \frac{\omega_r}{2\Delta\omega} = \frac{\text{Resonant frequency}}{\text{Bandwidth}}$$

Q-factor is a dimensionless quantity. The larger the value of Q-factor, the smaller the value of $2\Delta\omega$ or the bandwidth and sharper is the peak in the current or the series resonant circuit is more selective.

Fig. (13.21) shows that the lower angular frequency side of the resonance curve is dominated by the capacitor's reactance, the high angular frequency side is dominated by the inductor's reactance and resonance occurs in the middle.

Do you know?

The tuning circuit of a radio or TV is an example of LCR resonant circuit. Signals are transmitted by different stations at different frequencies which are picked up by the antenna. Corresponding to these frequencies a number of voltages appear across the series LCR circuit. But maximum current flows through the circuit for that AC voltage which has frequency equal to $f_r = \frac{1}{2\sqrt{LC}}$. If Q-value of the circuit is large, the signals of the other stations will be very weak. By changing the value of the adjustable capacitor C, the signal from the desired station can be tuned in.

13.10 Choke Coil:

If we use a resistance to reduce the current passing through an AC circuit, there will be loss of electric energy in the form of heat ($I^2 RT$) due to Joule heating. A choke coil helps to minimise this effect.

A choke coil is an inductor, used to reduce AC passing through a circuit without much loss of energy. It is made up of thick insulated copper wires wound closely in a large number of turns over a soft iron laminated core. Choke coil offers large resistance $X_L = \omega L$ to the flow of AC and hence current is reduced. Laminated core reduces eddy current loss.

Average power dissipated in the choke is $P = I_{rms} E_{rms} \cos\phi$, where the power factor $\cos\phi = \frac{R}{\sqrt{R^2 + \omega^2 L^2}}$.

For a choke coil, L is very large. Hence R is very small so $\cos\phi$ is nearly zero and power loss is very small. The only loss of energy is due hysteresis loss in the iron core, which can be reduced using a soft iron core.

Internet my friend

1. <https://en.m.wikipedia.org>
2. hyperphysics.phy-astr.gsu.edu
3. <https://www.britannica.com/science>
4. www.khanacademy.org

**Exercises****1. Choose the correct option.**

- i) If the rms current in a 50 Hz AC circuit is 5A, the value of the current $1/300$ seconds after its value becomes zero is
 (A) $5\sqrt{2}$ A (B) $5\sqrt{\frac{3}{2}}$ A
 (C) $\frac{5}{6}$ A (D) $\frac{5}{\sqrt{2}}$ A
- ii) A resistor of 500Ω and an inductance of 0.5 H are in series with an AC source which is given by $V = 100\sqrt{2} \sin(1000t)$. The power factor of the combination is
 (A) $\frac{1}{\sqrt{2}}$ (B) $\frac{1}{\sqrt{3}}$
 (C) 0.5 (D) 0.6
- iii) In a circuit L, C & R are connected in series with an alternating voltage of frequency f . the current leads the voltage by 45° . The value of C is
 (A) $\frac{1}{\pi f(2\pi fL - R)}$
 (B) $\frac{1}{2\pi f(2\pi fL - R)}$
 (C) $\frac{1}{\pi f(2\pi fL + R)}$
 (D) $\frac{1}{2\pi f(2\pi fL + R)}$
- iv) In an AC circuit, e and i are given by $e = 150 \sin(150t)$ V and $i = 150 \sin(150t + \frac{\pi}{3})$ A. the power dissipated in the circuit is
 (A) 106W (B) 150W
 (C) 5625W (D) Zero
- v) In a series LCR circuit the phase difference between the voltage and the current is 45° . Then the power factor will be
 (A) 0.607 (B) 0.707
 (C) 0.808 (D) 1

2. Answer in brief.

- i) An electric lamp is connected in series with a capacitor and an AC source is glowing with a certain brightness. How does the brightness of the lamp change on increasing the capacitance ?
- ii) The total impedance of a circuit decreases when a capacitor is added in series with L and R . Explain why ?
- iii) For very high frequency AC supply, a capacitor behaves like a pure conductor. Why ?
- iv) What is wattless current ?
- v) What is the natural frequency of L C circuit ? What is the reactance of this circuit at this frequency
3. In a series LR circuit $X_L = R$ and power factor of the circuit is P_1 . When capacitor with capacitance C such that $X_L = X_C$ is put in series, the power factor becomes P_2 . Calculate P_1 / P_2 .
4. When an AC source is connected to an ideal inductor show that the average power supplied by the source over a complete cycle is zero.
5. Prove that an ideal capacitor in an AC circuit does not dissipate power
6. (a) An emf $e = e_0 \sin \omega t$ applied to a series L - C - R circuit derives a current $I = I_0 \sin \omega t$ in the circuit. Deduce the expression for the average power dissipated in the circuit.
 (b) For circuits used for transporting electric power, a low power factor implies large power loss in transmission. Explain
7. A device Y is connected across an AC source of emf $e = e_0 \sin \omega t$. The current through Y is given as $i = i_0 \sin(\omega t + \pi/2)$
 a) Identify the device Y and write the expression for its reactance.
 b) Draw graphs showing variation of emf and current with time over one cycle of AC for Y.

- c) How does the reactance of the device Y vary with the frequency of the AC ? Show graphically
- d) Draw the phasor diagram for the device Y.
8. Derive an expression for the impedance of an LCR circuit connected to an AC power supply.
9. Compare resistance and reactance.
10. Show that in an AC circuit containing a pure inductor, the voltage is ahead of current by $\pi/2$ in phase.
11. An AC source generating a voltage $e = e_0 \sin \omega t$ is connected to a capacitor of capacitance C. Find the expression for the current i flowing through it. Plot a graph of e and i versus ωt .
12. If the effective current in a 50 cycle AC circuit is 5 A, what is the peak value of current? What is the current $1/600$ sec. after if was zero ?
[Ans: 7.07A, 3.535 A]
13. A light bulb is rated 100W for 220 V AC supply of 50 Hz. Calculate (a) resistance of the bulb. (b) the rms current through the bulb.
[Ans: 484 Ω , 0.45A]
14. A 15.0 μF capacitor is connected to a 220 V, 50 Hz source. Find the capacitive reactance and the current (rms and peak) in the circuit. If the frequency is doubled, what will happen to the capacitive reactance and the current.
[Ans: 212 Ω , 1.04 A, 1.47A, halved, doubled]
15. An AC circuit consists of only an inductor of inductance 2 H. If the current is represented by a sine wave of amplitude 0.25 A and frequency 60 Hz, calculate the effective potential difference across the inductor ($\pi = 3.142$)
[Ans: 133.32V]
16. Alternating emf of $e = 220 \sin 100 \pi t$ is applied to a circuit containing an inductance of $(1/\pi)$ henry. Write an equation for instantaneous current through the circuit. What will be the reading of the AC galvanometer connected in the circuit?
[Ans: $i = 2.2 \sin (100\pi t - \pi/2)$, 1.555A]
17. A 25 μF capacitor, a 0.10 H inductor and a 25 Ω resistor are connected in series with an AC source whose emf is given by $e = 310 \sin 314 t$ (volt). What is the frequency, reactance, impedance, current and phase angle of the circuit?
[Ans: 50Hz, 95.9 Ω , 99.1 Ω , 2.21A, 1.31 rad]
18. A capacitor of 100 μF , a coil of resistance 50 Ω and an inductance 0.5 H are connected in series with a 110 V-50Hz source. Calculate the rms value of current in the circuit.
[Ans: 0.816A]
19. Find the capacity of a capacitor which when put in series with a 10 Ω resistor makes the power factor equal to 0.5. Assume an 80V-100Hz AC supply.
[Ans: 9.2×10^{-5} F]
20. Find the time required for a 50 Hz alternating current to change its value from zero to the rms value.
[Ans: 2.5×10^{-3} s]
21. Calculate the value of capacity in picofarad, which will make 101.4 micro henry inductance to oscillate with frequency of one megahertz.
[Ans: 249.7 picofarad]
22. A 10 μF capacitor is charged to a 25 volt of potential. The battery is disconnected and a pure 100 m H coil is connected across the capacitor so that LC oscillations are set up. Calculate the maximum current in the coil.
[Ans: 0.25 A]
23. A 100 μF capacitor is charged with a 50 V source supply. Then source supply is removed and the capacitor is connected across an inductance, as a result of which 5A current flows through the inductance. Calculate the value of the inductance.
[Ans: 0.01 H]

14. Dual Nature of Radiation and Matter



Can you recall?

1. What is electromagnetic radiation?
2. What are the characteristics of a wave?
3. What do you mean by frequency and wave number associated with a wave?
4. What are the characteristic properties of particles of matter?
5. How do we define momentum of a particle?
6. What are the different types of energies that a particle of matter can possess?

14.1 Introduction:

In earlier chapters you have studied various optical phenomena like reflection, refraction, interference, diffraction and polarization of light. Light is electromagnetic radiation and most of the phenomena mentioned have been explained considering light as a wave. We are also familiar with the wave nature of electromagnetic radiation in other regions like X-rays, γ -rays, infrared and ultraviolet radiation and microwaves apart from the visible light. Electromagnetic radiation consists of mutually perpendicular oscillating electric and magnetic fields, both being perpendicular to the direction in which the wave and energy are travelling.

In Chapter 3 on Kinetic Theory of Gases and Radiation, you have come across spectrum of black body radiation which cannot be explained using the wave nature of radiation. Such phenomena appear during the interaction of radiation with matter and need quantum physics to explain them.

The idea of '*quantization of energy*' was first proposed by Planck to explain the black body spectrum. Planck proposed a model that says (i) energy is emitted in packets and (ii) at higher frequencies, the energy of a packet is large. Planck assumed that atoms behave

like tiny oscillators that emit electromagnetic radiation only in discrete packets ($E = nh\nu$), where ν is the frequency of oscillator. The emissions occur only when the oscillator makes a jump from one quantized level of energy to another of lower energy. This model of Planck turned out to be the basis for Einstein's theory to explain the observations of experiments on photoelectric effect which we will study in the following section.

14.2 The Photoelectric Effect:

Heinrich Hertz discovered photoelectric emission in 1887 while he was working on the production of electromagnetic waves by spark discharge. He noticed that when ultraviolet light is incident on a metal electrode, a high voltage spark passes across the electrodes. Actually electrons were emitted from the metal surface. The surface which emits electrons, when illuminated with appropriate radiation, is known as a photosensitive surface.

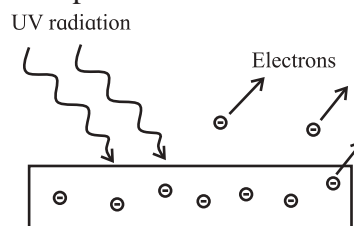

Fig. 14.1: Process of photoelectric effect.

The phenomenon of emission of electrons from a metal surface, when radiation of appropriate frequency is incident on it, as shown in Fig. 14.1, is known as photoelectric effect. For metals like zinc, cadmium, magnesium etc., ultraviolet radiation is necessary while for alkali metals, even visible radiation is sufficient.

Electrical energy can be obtained from light (electromagnetic radiation) in two ways (i) photo-emissive effect as described above and (ii) photo-voltaic effect, used in a solar cell. In the latter case, an electrical potential difference is generated in a semiconductor using solar energy.

14.2.1 Experimental Set-up of Photoelectric Effect:

A typical laboratory experimental set-up for the photoelectric effect (Fig. 14.2) consists of an evacuated glass tube with a quartz window containing a photosensitive metal plate - the emitter E and another metal plate - the collector C. The emitter and collector are connected to a voltage source whose voltage can be changed and to an ammeter to measure the current in the circuit. A potential difference of V , as measured by the voltmeter, is maintained between the emitter E (the cathode) and collector C (the anode), normally C being at a positive potential with respect to the emitter. This potential difference can be varied and C can even be at negative potential with respect to E. When the anode potential V is positive, it accelerates the electrons (hence called accelerating potential) while when the anode potential V is negative, it retards the flow of electrons (therefore known as retarding potential). A source S of monochromatic light (light corresponding to only one specific frequency) of sufficiently high frequency (short wavelength $\leq 10^{-7}$ m) is used.

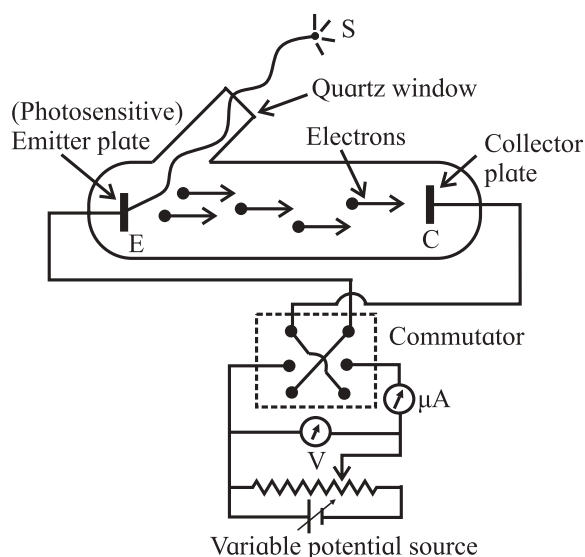

Fig. 14.2: Schematic of experimental set-up for photoelectric effect.

Light is made to fall on the surface of the metal plate E and electrons are ejected

from the metal through its surface. These electrons, called photoelectrons, are collected at the collector C (photoelectron are ordinary electrons, they are given this name to indicate that they are emitted due to incident light). We now know that free electrons are available in a metal plate. They are emitted if sufficient energy (we will know more about this energy later in the Chapter) is supplied to them to overcome the barrier that keeps them inside the metal.

In the late nineteenth century, these facts were not known and scientists working on photoelectric effect performed various experiments and noted down their observations. These observations are summarized below. We will try to analyze these observations and their explanation.

14.2.2 Observations from Experiments on Photoelectric Effect:

1. When ultraviolet radiation was incident on the emitter plate, current I was recorded even if the intensity of radiation was very low. Photocurrent I was observed only if the frequency of the incident radiation was more than some threshold frequency ν_0 . ν_0 was same for a given metal and was different for different metals used as the emitter. For a given frequency $\nu (> \nu_0)$ of the incident radiation, no matter how feeble was the light meaning however small the intensity of radiation be, electrons were always emitted.
2. There was no time lag between the incidence of light and emission of electrons. The photocurrent started instantaneously (within 10^{-9} s) on shining the radiation even if the intensity of radiation was low. As soon as the incident radiation was stopped, the flow of current stopped.
3. Keeping the frequency ν of the incident radiation and accelerating potential V fixed, if the intensity was increased, the photo current increased linearly with intensity as shown in Fig. 14.3.

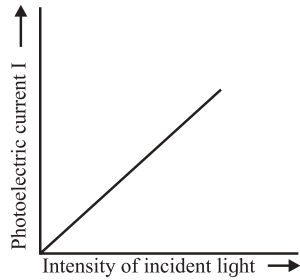

Fig. 14.3: Photocurrent as a function of incident intensity for fixed incident frequency and accelerating potential.

4. The photocurrent I could also be varied by changing the potential of the collector plate. I was dependent on the accelerating potential V (potential difference between the emitter and collector) for given incident radiation (intensity and frequency were fixed). Initially the current increased with voltage but then it remained constant. This was termed as the saturation current I_0 (Fig. 14.4).

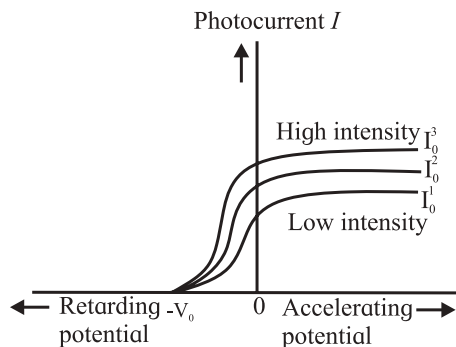

Fig. 14.4: Photocurrent as a function of accelerating potential for fixed incident frequency and different incident intensities.

5. Keeping the accelerating voltage and incident frequency fixed, if the intensity of incident radiation was increased, the value of saturation current also increased proportionately, e.g., if the intensity was doubled, the saturation current was also doubled.
6. The maximum kinetic energy KE_{\max} (and hence the maximum velocity) of the electrons depended on the potential V for a given metal used for the emitter plate and for a given frequency of the incident radiation. If the material is changed or

the frequency of the incident radiation is changed, KE_{\max} changed. It did not depend on the intensity of the incident radiation. Thus, even for very small incident intensity, if the frequency of incident radiation was larger than the threshold frequency ν_0 , KE_{\max} from a given surface was always the same for a given incident frequency.

7. If increasingly negative potentials were applied to the collector, the photocurrent decreased and for some typical value $-V_0$, photocurrent became zero. V_0 was termed as cut-off or stopping potential. It indicated that when the potential was retarding, the photoelectrons still had enough energy to overcome the retarding (opposing) electric field and reach the collector. Value of V_0 was same for any incident intensity as long as the incident frequency was same (Fig. 14.4) but was different for different emitter materials.
8. If the frequency of incident radiation was changed keeping the intensity and accelerating potential V constant, then the saturation current remained the same but the stopping potential V_0 changed. This observation is depicted in Fig. 14.5. The stopping potential V_0 varied linearly with ν as shown in Fig. 14.6. For different metals, the slopes of such straight lines were the same but the intercepts on the frequency and stopping potential axes were different.

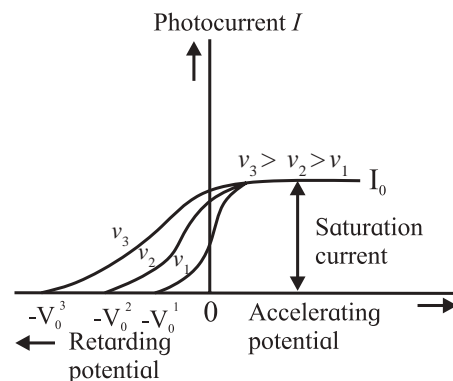

Fig. 14.5: Photocurrent as a function of accelerating potential for fixed incident intensity but different incident frequencies for the same emitter material.

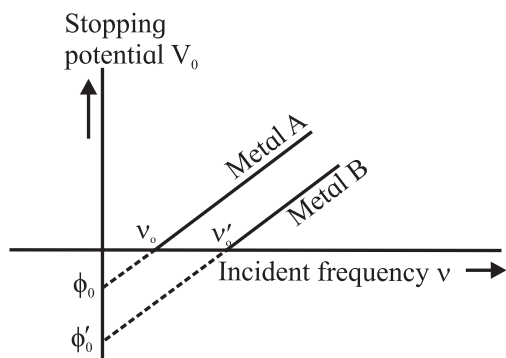

Fig. 14.6: Stopping potential as a function of frequency of incident radiation for emitters made of different metals.

9. The photocurrent and hence the number of electrons depended on the intensity but not on the frequency of incident radiation, as long as the incident frequency was larger than the threshold frequency ν_0 and the potential of anode was higher than that of cathode.

14.2.3 Failure of Wave Theory to Explain the Observations from Experiments on Photoelectric Effect:

Most of these observations could not be explained by the wave theory of electromagnetic radiation. First and foremost was the instantaneous emission of electrons on incidence of light. Wave picture would expect that the metal surface will absorb the incident energy continuously. All the electrons near the surface will absorb energy. The metal surface will require reasonable time (\sim few minutes to hours) to accumulate sufficient energy to knock off electrons. Greater the intensity of incident radiation, more will be the incident energy, hence expected time required to knock off the electrons will be less. For small incident intensity, the energy incident on unit area in unit time will be small, and will take longer to knock off the electrons. These arguments were contradictory to observations.

Let us try to estimate the time that will be required for the photocurrent to start. We need to define the term 'work function' of a metal for this exercise.

We know that metals have free electrons. This fact makes metals good conductors of heat and electricity. These electrons are free to move inside the metal but are otherwise confined inside the metal. They cannot escape from the surface unless sufficient energy is supplied to them. The minimum amount of energy required to be provided to an electron to pull it out of the metal from the surface is called the **work function of the metal** and is denoted by ϕ_0 . Work function depends on the properties of the metal and the nature of its surface. Values of work function of metals are generally expressed in a unit of energy called the electron volt (eV).

You have studied ionization energy of an atom. What is ionization energy to an atom is the work function to a solid which is a large collection of atoms.

Table 14.1 : Typical values of work function for some common metals.

Metal	Work function (in eV)
Potassium	2.3
Sodium	2.4
Calcium	2.9
Zinc	3.6
Silver	4.3
Aluminum	4.3
Tungsten	4.5
Copper	4.7
Nickel	5.0
Gold	5.1

Example 14.1: Radiation of intensity $0.5 \times 10^{-4} \text{ W/m}^2$ falls on the emitter in a photoelectric set-up. The emitter (cathode) is made up of potassium and has an area of 5 cm^2 . Let us assume that the electrons from only the surface are knocked off by the radiation. According to the wave theory, what will be the time required to notice some deflection in the microammeter

connected in the circuit? (Given the metallic radius of potassium atom is 230 pm and work function of potassium is 2.3 eV.)

Solution : Given

Intensity of radiation = $0.5 \times 10^{-4} \text{ W/m}^2$,

Area of cathode = $5 \text{ cm}^2 = 5 \times 10^{-4} \text{ m}^2$.

Radius of potassium atom = 230 pm
= $230 \times 10^{-12} \text{ m}$

Work function of potassium = 2.3 eV
= $2.3 \times 1.6 \times 10^{-19} \text{ J}$

The number N of electrons present on the surface of cathode can be approximately calculated assuming that each potassium atom contributes one electron and the radius of potassium atom is $230 \times 10^{-12} \text{ m}$.

$N = \text{Area of cathode} / \text{area covered by one atom}$

$$= \frac{5 \times 10^{-4}}{(3.1415 \times 230 \times 10^{-12})^2} \\ = 3009 \times 10^{12}$$

Incident power on the cathode is

$$= 0.5 \times 10^{-4} \text{ W/m}^2 \times 5 \times 10^{-4} \text{ m}^2 \\ = 2.5 \times 10^{-8} \text{ W}$$

Wave theory assumes that this power distributed over the whole area of the cathode is uniformly absorbed by all the electrons. Therefore the energy absorbed by each electron in one second is

$$= \frac{2.5 \times 10^{-8} \text{ W}}{3009 \times 10^{12}} \approx 8.31 \times 10^{-24} \text{ W}$$

Work function of potassium is

$$2.30 \text{ eV} = 2.30 \times 1.6 \times 10^{-19} \text{ J} \\ = 3.68 \times 10^{-19} \text{ J}$$

Hence each electron will require minimum $3.68 \times 10^{-19} \text{ J}$ of energy to be knocked off from the surface of the cathode.

The time required to accumulate this energy will be

$$\frac{3.68 \times 10^{-19} \text{ J}}{8.31 \times 10^{-24} \text{ W}} \\ = 0.443 \times 10^5 \text{ s, which is about half a day.}$$

Secondly, since larger incident intensity implies larger energy, the electrons are expected to be emitted with larger kinetic energy. But the observation showed that the

maximum kinetic energy did not depend on the incident intensity but depended on the incident frequency. According to wave theory, frequency of incident radiation has no role in determining the kinetic energy of photoelectrons. Moreover, wave theory expected photoelectrons to be emitted for any frequency if the intensity of radiation was large enough. But observations indicated that for a given metal surface, some characteristic cut-off frequency ν_0 existed below which no photoelectrons were emitted however intense the incident radiation was and photoelectrons were always emitted if incident frequency ν was greater than ν_0 even if the intensity was low.

14.2.4 Einstein's Postulate of Quantization of Energy and the Photoelectric Equation:

Planck's hypothesis of energy quantization to explain the black body radiation was extended by Einstein in 1905 to all types of electromagnetic radiations. Einstein proposed that under certain conditions, light behaves as if it was a particle and its energy is released or absorbed in bundles or quanta. He named the quantum of energy of light as photon with energy $E = h\nu$, where ν is the frequency of light and h is a constant defined by Planck in his model to explain black body radiation. It is now known as the Planck's constant and has a value $6.626 \times 10^{-34} \text{ J s}$.

It may be noted that the equation

$$E = h\nu \quad \text{--- (14.1)}$$

is a relation between a particle like property, the energy E and a wave like property, the frequency ν . Equation (14.1) is known as the Einstein's relation.

Einstein's relation (14.1) holds good for the entire electromagnetic spectrum. It says that energy of electromagnetic radiation is directly proportional to the frequency (and is inversely proportional to the wavelength since $\nu = c/\lambda$). Hence high frequency radiation

means high energy radiation. Alternatively, short wavelength radiation means high energy radiation.

Example 14.2: (a) Calculate the energies of photons corresponding to ultraviolet light and red light, given that their wavelengths are 3000 \AA and 7000 \AA respectively. (Remember that the photon are not coloured. Colour is human perception for that frequency range.) (b) A typical FM radio station has its broadcast frequency 98.3 MHz . What is the energy of an FM photon of this frequency?

Solution: Given

$$\lambda_{\text{uv}} = 3000 \text{ \AA} = 3000 \times 10^{-10} \text{ m},$$

$$\lambda_{\text{red}} = 7000 \text{ \AA} = 7000 \times 10^{-10} \text{ m and}$$

$$\nu_{\text{FM}} = 98.3 \text{ MHz} = 98.3 \times 10^6 \text{ s}^{-1}$$

We know that energy E of electromagnetic radiation of frequency ν is $h\nu$ and if λ is the corresponding wavelength, then $\lambda\nu = c$, c being the speed of electromagnetic radiation in vacuum.

$$\text{Hence, } E = h\nu = \frac{hc}{\lambda}$$

(a)

$$E = \frac{6.63 \times 10^{-34} \text{ J s} \times 3 \times 10^8 \text{ m s}^{-1}}{3000 \times 10^{-10} \text{ m}}$$

$$= 6.63 \times 10^{-19} \text{ J} = 4.147 \text{ eV}$$

for a photon corresponding to ultraviolet light and

$$E = \frac{6.63 \times 10^{-34} \text{ J s} \times 3 \times 10^8 \text{ m s}^{-1}}{7000 \times 10^{-10} \text{ m}}$$

$$= 2.84 \times 10^{-19} \text{ J} = 1.77 \text{ eV}$$

for a photon corresponding to red light.

(b) The energy of photon of FM frequency 98.3 MHz is $6.63 \times 10^{-34} \text{ J s} \times 98.3 \times 10^6 \text{ s}^{-1}$
 $= 651.73 \times 10^{-28} \text{ J} = 40.73 \times 10^{-8} \text{ eV}$.

This is very small energy as compared to the photon energy in the visible range.

- Wavelength (in \AA) \times energy (in eV) ≈ 12500 (numerically)
- Wavelength (in nm) \times energy (in eV) ≈ 1250 (numerically)



Try this

Determine the wavelengths and frequencies for photons of energies (i) 10^{-12} J , (ii) 10^{-15} J , (iii) 10^{-18} J , (iv) 10^{-21} J and (v) 10^{-24} J .

Accordingly prepare a chart (along a horizontal line) of various regions of electromagnetic spectrum and identify these regions in categories that you know. Compare your results with a standard chart from any reference book or from Internet. You would notice that γ photons are the most energetic photons and their energies are $\sim 10^{-13} - 10^{-12} \text{ J}$. This is a very small amount of energy on the human scale and therefore we do not notice individual photons along their passage.

The explanation using Einstein's postulate of quantization of energy for the observations mentioned in section 14.2.2 is given below.

1. Einstein argued that when a photon of ultraviolet radiation arrives at the metal surface and collides with an electron, it gives all of its energy $h\nu$ to the electron. The energy is gained by the electron and the photon no longer exists. If ϕ_0 is the work function of the material of the emitter plate, then electrons will be emitted if and only if the energy gained by the electrons is more than or equal to the work function i.e., $h\nu \geq \phi_0$. Thus, a minimum or threshold frequency ν_0 ($= \phi_0/h$) is required to eject electrons from the metal surface. If $\nu < \nu_0$, the photon will not have enough energy to liberate an electron. As a result, no electron will be ejected however intense the incident radiation is. Similarly if $\nu > \nu_0$, the energy will always be sufficient to eject an electron, however small the incident intensity is.
2. Energy is given by the photon to the electron as soon as the radiation is incident on the surface. The exchange of energy between the photon and electron

- is instantaneous. Hence there is no time lag between the incidence of light and emission of electrons. Also when the incident radiation is stopped, there are no photons to transfer the energy to electrons, hence the photoemission stops immediately.
- According to Einstein's proposition, if the intensity of incident radiation for a given wavelength is increased, there will be an increase in the number of energy quanta (photons) incident on unit area in unit time; the energy of each quantum being the same ($= h\nu = hc/\lambda$). Therefore larger intensity radiation will knock off more number of electrons from the surface and hence the current will be larger (if $\nu > \nu_0$). Conversely lower intensity implies less number of incident photons, hence, less number of ejected electrons and therefore lower current.
 - Once the electron is emitted from the surface, if the collector is at a higher potential than the emitter, the electric field will accelerate the electrons towards the collector. Higher is the accelerating potential, more will be number of electrons reaching the collector. Hence the photocurrent I increases with the accelerating potential initially. Moreover, since the intensity of incident radiation determines the number of photons incident on the metal surface on unit area in unit time, it determines the maximum number of electrons that can be knocked off by the incident radiation. Hence for a given intensity, increasing the accelerating potential can increase the current only till all the knocked off electrons have reached the collector. No increase can be seen in the current beyond this limit. This explains the saturation current I_0 .
 - Increasing the incident intensity will increase the number of incident photons and eventually the saturation current.
 - If the frequency of incident radiation is more than the threshold frequency, then the energy ϕ_0 is used by the electron to escape from the metal surface and remaining energy of the photon becomes the kinetic energy of the electron. Depending on the energy of the electron inside the metal and other processes like collisions after emission from the surface, the maximum kinetic energy is equal to $(h\nu - \phi_0)$. Hence,

$$KE_{\max} = h\nu - \phi_0 \quad \text{--- (14.2)}$$
 Equation (14.2) is known as Einstein's photoelectric equation. KE_{\max} depends on the material of the emitter plate and varies linearly with the incident frequency ν ; it is independent of the intensity of the incident radiation.
 - The electrons that are emitted from the metal surface have different kinetic energies. The reasons for this are many-fold: all the electrons in a solid do not possess the same energy, the electrons may be ejected from varying depths inside the metal surface, electrons may suffer collisions before they come out of the metal surface and may lose their energy etc. If V is the potential difference between the emitter and collector and the collector is at a lower potential, an electron will lose its kinetic energy in overcoming the retarding force. If the kinetic energy is not sufficient, the emitted electrons may not reach the collector and the photocurrent will be zero. If KE_{\max} is the energy of the most energetic electron at the emitter surface (where its potential energy is zero) and $-V_0$ is the stopping potential, then this electron will fail to reach the collector if $KE_{\max} < eV_0$, where e is the electron charge and eV_0 is the energy needed for the electron to overcome the retarding potential V_0 . If the electron just fails to

reach the collector, i.e., it has lost all its kinetic energy just at the collector, $KE_{\max} = eV_0$ and the photocurrent becomes zero. Equation (14.2) then explains that stopping potential V_0 depends on the incident frequency and the material of the emitter and does not depend on the incident intensity.

8. If the ejected electrons have kinetic energy more than eV_0 , electrons can reach the collector, hence current flows. When the kinetic energy of the electron is less than or equal to eV_0 , no current will flow. Photocurrent will become zero when $KE_{\max} = eV_0$. Using $KE_{\max} = eV_0$, we can write Eq. (14.2) as

$$eV_0 = h\nu - \phi_0$$

or, $V_0 = \left(\frac{h}{e}\right)\nu - \frac{\phi_0}{e}$ --- (14.3)

Above equation tells us that V_0 varies linearly with incident frequency ν , and the slope of the straight line depends on constants h and e while the intercept of the line depends on the material through ϕ_0 . Thus the slope of lines in Fig. 14.6 is same and is independent of the material of the emitter but intercepts are different for different materials.

9. All the above arguments thus bring out the fact that the magnitude of photocurrent depends on the incident intensity through the number of emitted photoelectrons and the potential V of the collector but not on the incident frequency ν as long as $\nu > \nu_0$.

Thus all the observations related to the experiments on photoelectric effect were explained by Einstein's hypothesis of existence of a photon or treating light as bundles of energy. Although Einstein gave his hypothesis in 1905, it was not widely accepted by the scientific community. In 1909, when Millikan measured the charge of an electron and the value of h , calculated from Eq. (14.3), matched with the value given by Planck, the hypothesis

was accepted. The work function values ϕ_0 for some metals were also confirmed from Eq. (14.3). Einstein and Millikan received Nobel prizes for their respective discoveries in 1921 and 1923 respectively.



Use your brain power

You must have seen light emitting diodes (LEDs) of different colours. In LED, electrical energy is converted into light energy corresponding to different colours. Can you tell what must be the difference in the working of LEDs of different colours.

Design an experiment using LEDs to determine the value of Planck's constant.

You might know that Nobel prize in physics for the year 2014 was awarded to Professors Isamu Akasaki, Hiroshi Amano and Shuji Nakamura for the invention of blue LEDs. They made the first blue LED in the early 1990s. Try to search on the Internet why it was difficult to make a blue LED.

According to Einstein, energy of radiation of frequency ν comes in bundles with magnitude $h\nu$. Thus energy of a light beam having n photons will be $nh\nu$, where n can take only integral values. Is it then possible to vary the incident energy continuously? Why we do not see individual photons? To understand this issue, let us consider the following example.

Example 14.3: The wavelength and intensity of the incident light is 4000 \AA and 0.1 W respectively. What is the minimum change in the light energy? What is the number of incident photons?

Solution : Given incident intensity = 0.1 W and $\lambda = 4000 \text{ \AA} = 4000 \times 10^{-10} \text{ m}$.

The energy E of a photon of given wavelength is

$$E = h\nu = \frac{hc}{\lambda} = \frac{6.63 \times 10^{-34} \text{ J s} \times 3 \times 10^8 \text{ m/s}}{4000 \times 10^{-10} \text{ m}}$$

$$= 4.97 \times 10^{-19} \text{ J}$$

This is the minimum change in energy and is very small. The change in energy can therefore be considered as continuous.

Number of photons N incident per second is

$$N = \frac{0.1 \text{ W}}{4.97 \times 10^{-19} \text{ J}} \approx 2 \times 10^{17}$$

The number of photons coming out is so large that human eye cannot comprehend or count it. Even if one wishes to count, say 10 photons per second, $\sim 10^9$ years will be required.



Can you tell?

- A particular metal used as a cathode in an experiment on photoelectric effect does not show photoelectric effect when it is illuminated with green light. Which of the colours in the visible spectrum are likely to generate photocurrent?

Table 14.2 : Summary of analysis of observations from experiments on photoelectric effect.

Observation	Wave theory	Photon picture
Electrons are emitted as soon as the light is incident on the metal surface.	Very intense light is needed for instantaneous emission of electrons.	Only one photon is needed to eject one electron from the metal surface and energy exchange between electron and photon is instantaneous on collision.
Very low intensity of incident light is also sufficient to generate photocurrent.	Low intensity should not give photocurrent.	Low intensity of incident light means less number of photons and not low energy photons. Hence low current will be produced.
High intensity gives larger photocurrent means higher rate of release of electrons.	High intensity means higher energy radiation and therefore more electrons are emitted.	Higher intensity means more number of photons incident in unit time, therefore more number of electrons are emitted in unit time and hence photocurrent is larger.
Increasing the intensity has no effect on the electron energy.	Higher intensity should mean electrons emitted with higher energies.	Higher intensity means higher number of incident photons per unit time. Energy of photon is same as it does not depend on the intensity.
A minimum threshold frequency is needed for photocurrent to start.	Low frequency light should release electrons but would take more time.	A photon of low frequency light will not have sufficient energy to release an electron from the surface.
Increasing the frequency of incident light increases the maximum kinetic energy of electrons.	Increasing intensity should increase the maximum kinetic energy. Maximum kinetic energy should not depend on the incident frequency.	Increasing the frequency increases the energy of the photon. Therefore electrons receive more energy which results in increasing the maximum kinetic energy.

14.3 Wave-Particle Duality of Electromagnetic Radiation:

In its interaction with matter, light behaves as if it is made up of packets of energy called quanta. Later it was confirmed from other theoretical and experimental investigations that these light quanta can have associated

momentum. Hence the question came up whether a particle can be associated with light or electromagnetic radiation in general. Particle nature was confirmed by Compton in 1924 in experiments on scattering of X-rays due to electrons of matter. Summary of these results is given in the box below and you can

know more about these experiments from the reference books given at the end of this book or from the links given below

- http://physics.usask.ca/~bzulkosk/modphyslab/phys251manual/compton_2009.pdf
- [http://www.phys.utk.edu/labs/modphys/Compton Scattering Experiment.pdf](http://www.phys.utk.edu/labs/modphys/Compton%20Scattering%20Experiment.pdf)
- <http://hyperphysics.phy-astr.gsu.edu/hbase/quantum/comptint.html>



Do you know?

The particle nature of radiation is seen in black body radiation and photoelectric effect. In the former, near room temperature, the radiation is mostly in the infrared region while in the latter it is in the visible and ultraviolet region of the spectrum. The third experiment, which established that a photon possesses momentum like a particle, was Compton scattering where X-rays and γ -rays interact with matter. In 1923, A. H. Compton made a monochromatic beam of X-rays, of wavelength λ , incident on a graphite sheet and measured the intensity of the scattered rays in different directions as a function of wavelength. He found that although the incident beam consisted of a single wavelength λ , the scattered intensity was maximum at two wavelengths. One of these was same as the incident wavelength but the other λ' was larger by an amount $\Delta\lambda$. $\Delta\lambda$ is known as the Compton shift that depends on the scattering angle.

Compton explained his observations by considering incidence of X-ray beam on graphite as collision of X-ray photons with the electrons of graphite, like collision of billiard balls. Energy and momentum is transferred during the collision and scattered photons have lower energy than the incident photons. Therefore they have lower frequency or higher wavelength. The

Compton shift is given by the relation

$$\Delta\lambda = \lambda' - \lambda = \frac{h}{m_e c} (1 - \cos\theta)$$

where θ is the scattering angle. The shift depends only on the scattering angle and not on the incident wavelength. This shift cannot be explained using wave theory. If we let the Planck's constant go to zero, we get the result expected from wave theory. This is the test to check whether the new picture is correct or not.

Compton showed that photon has an associated momentum along with the energy it carries. All photons of electromagnetic radiation of a particular frequency have the same energy and momentum. Photons are electrically neutral and are not deflected by electric or magnetic fields. Photons can have particle-like collisions with other particles such as electrons. In photon – particle collision, energy and momentum of the system are conserved but the number of photons is not conserved. Photons can be absorbed or new photons can be created. Photons can transfer their energy and momentum during collisions with particles and disappear. When we turn on light, they are created. Photon always moves with the speed of light, it is never at rest. Mass of a photon is not defined as we do for a particle in Newtonian mechanics. Its rest mass is zero (in all frames of reference).

Effects of wave nature of light were seen in experiments on interference or diffraction when the slit widths or the separation between two slits are smaller than or comparable to the wavelength of light. If the slit width is large or the spacing between slits is more, the interference or diffraction patterns will not be same and the wave nature will not be so obvious.

It was realized by scientists that some phenomena observed in experiments in the laboratory or in nature (like interference and

diffraction) can be explained by considering light in particular, and electromagnetic radiation in general, as a wave. On the other hand, some other observations (like photoelectric effect and black body radiation) can be explained only if we consider electromagnetic radiation as consisting of photons with definite quantum of energy (and momentum as evident from Compton scattering experiments). Also there are some phenomena which can be explained by both the theories. It is therefore essential to consider that both the characters or behaviours hold good; *one dominates in some situations and the other works in rest of the situations*. It is necessary to keep both the physical models to explain the careful experimental observations. There is thus a need to hypothesize the dual character of light. Later it turned out that such a picture is required not only for light but for the whole electromagnetic spectrum. **This phenomenon is termed as wave-particle duality of electromagnetic radiation.**

14.4 Photo Cell:

Photo cell is a device that makes use of the photoelectric effect and converts light energy into electrical energy. Schematic of a photocell is shown in Fig. 14.7. It consists of a semi-cylindrical photosensitive metal plate E (acting as a cathode) and a wire loop collector C (acting as an anode) supported in an evacuated glass or quartz bulb. The electrodes are connected to an external circuit having a high tension battery B and a microammeter μA . Instead of a photosensitive metal plate, the photosensitive material can be pasted in the form of a thin film on the inner walls of the glass bulb.

When light of suitable wavelength falls on the cathode, photoelectrons are emitted. These electrons are attracted towards the anode due to the applied electric field. The generated photocurrent is noted from the microammeter. Photocell is used to operate control systems and in light measuring devices. Light meters in

photographic cameras make use of photocell to measure the intensity of light. Photocell can also be used to switch on or off the street lights.

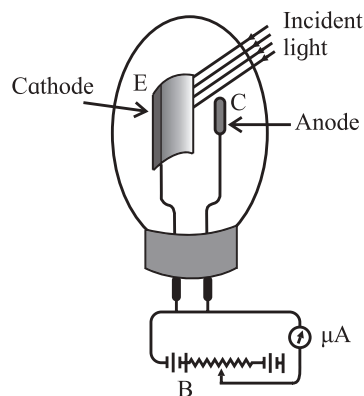

Fig. 14.7 : Schematic of a photocell.

Suppose source of ultraviolet radiation is kept near the passage or entrance of a mall or house and the light is made incident on the cathode of a photocell, photocurrent is generated. When a person passes through the passage or comes near the entrance, incident light beam is interrupted and photocurrent stops. This event can be used to operate a counter in counting devices, or to set a burglar alarm. Such an arrangement can be used to identify traffic law defaulters by setting an alarm using the photocell.



Use your brain power

Is solar cell a photocell?

14.5 De Broglie Hypothesis:

In 1924, Prince Louis de Broglie (pronounced as 'de broy') proposed, on the basis of the symmetry existing in nature, that if radiation has dual nature - sometimes wave nature dominates and sometimes particle nature, matter may also possess dual nature. Normally we talk about matter as composed of particles, but are there situations where matter seems to show wave-like properties? This will become evident from the experiments on diffraction of electrons from nickel crystals described later in this chapter.

De Broglie used the properties, frequency ν and wavelength λ , of a wave and proposed a relation to connect these with the particle

properties, energy E and momentum p . The momentum p carried by a photon of energy E is given by the relation

$$p = \frac{E}{c} \quad \text{--- (14.4)}$$

which is valid for a massless particle travelling with the speed of light c according to Einstein's special theory of relativity. Using the Einstein's relation for E ,

$$p = \frac{E}{c} = \frac{h\nu}{c} = \frac{h}{\lambda} \quad \text{--- (14.5)}$$

where λ , the wavelength, is given by $\lambda\nu = c$.

De Broglie proposed that a moving material particle of total energy E and momentum p has associated with it a wave analogous to a photon. He then suggested that the wave and particle properties of matter can also be described by a relation similar to Eq. (14.5) for a photon. Thus frequency and wavelength of a wave associated with a material particle, of mass m moving with a velocity v , are given as

$$\begin{aligned} v &= E/h \text{ and} \\ \lambda &= h/p = h/mv \end{aligned} \quad \text{--- (14.6)}$$

He referred to these waves associated with material particles as *matter waves*. The wavelength of the matter waves, given by Eq. (14.6), is now known as de Broglie wavelength. Greater is the momentum, shorter is the wavelength. Equation (14.6) for the wavelength of matter waves is known as de Broglie relation.

For a particle of mass m moving with a velocity v , the kinetic energy

$$E_K = \frac{1}{2}mv^2 \text{ or } v = \sqrt{\frac{2E_K}{m}}$$

Thus,
$$\lambda = \frac{h}{mv} = \frac{h}{m\sqrt{\frac{2E_K}{m}}} = \frac{h}{\sqrt{2mE_K}}$$

For a charged particle of charge q , accelerated from rest, through a potential difference V , the work done is qV . This provides the kinetic energy. Thus $E_K = qV$.

$$\therefore \lambda = \frac{h}{\sqrt{2mE_K}} = \frac{h}{\sqrt{2mqV}}$$

This relation holds for any charged particle like electron, proton or for even

charged ions where m corresponds to the mass of the charged particle. Of course, when V is very large (say in kV), so that the speed of the particle becomes close to the speed of light, such an equation will not be applicable. You will learn about other effects in such situations in higher classes.

For an electron moving through a potential difference of V (given in volts)

$$\begin{aligned} \lambda &= \frac{h}{\sqrt{2m_e eV}} \\ &= \frac{6.63 \times 10^{-34} \text{ J s}}{\sqrt{2 \times 9.11 \times 10^{-31} \text{ kg} \times 1.6 \times 10^{-19} \text{ C} \times V \text{ (in volts)}}} \\ &= \frac{1.228 \times 10^{-9}}{\sqrt{V \text{ (in volts)}}} \text{ m} \end{aligned}$$

or,
$$\lambda \text{ (in nm)} = \frac{1.228}{\sqrt{V \text{ (in volts)}}} \quad \text{--- (14.7)}$$

Example 14.4: An electron is accelerated through a potential of 120 V. Find its de Broglie wavelength.

Solution: Given $V = 120$ V.

We know that $\lambda = \frac{1.228}{\sqrt{V}}$ using Eq. (14.7).

$$\therefore \lambda = \frac{1.228}{\sqrt{120}} = 0.112 \text{ nm.}$$



Use your brain power

Can you estimate the de Broglie wavelength of the Earth?



Can you tell?

➤ The expression $p = E/c$ defines the momentum of a photon. Can this expression be used for momentum of an electron or proton?

Shortly after the existence of photons (particles associated with electromagnetic waves) was postulated, it was also experimentally found that electrons sub-atomic and atomic particles like protons and neutrons

also exhibit wave properties. The wavelength associated with an electron of energy few eV is of the order of few Å. Therefore to observe the wave nature of electron, slit width or diffracting objects should be of same order of magnitude (few Å).

The wave property of electron was confirmed experimentally in 1927 by Davisson and Germer in America and in 1928 by George P. Thomson in England by diffraction of electrons by atoms in metals. Knowing that the size of the atoms and their spacing in crystals is of the order of few Å, they anticipated that if electrons are scattered by atoms in a crystal, the associated matter waves will interfere and will show diffraction effects. It turned out to be true in their experiments. Electrons showed constructive and destructive interference. No electrons were found in certain directions due to destructive interference while in other directions, maximum numbers of electrons were seen due to constructive interference.

Louis de Broglie received the Nobel prize in Physics in 1929 and Davisson, Germer and Thomson shared the Nobel prize in Physics in 1937. It was amazing that Sir J. J. Thomson discovered the existence of electron as a sub-atomic **particle** while his son G. P. Thomson showed that electron behaves like a **wave**.

14.6 Davisson and Germer Experiment:

A schematic of the experimental arrangement of the Davisson and Germer experiment is shown in Fig. 14.8. The whole set-up is enclosed in an evacuated chamber. It uses an electron gun - a device to produce electrons by heating a tungsten filament F using a battery B. Electrons from the gun are accelerated through vacuum to a desired velocity by applying suitable accelerating potential across a cylindrical anode and are collimated into a focused beam. This beam of electrons falls on a nickel crystal and is scattered in different directions by the atoms of the crystal. Thus, in the Davisson and Germer

experiment, electrons were used in place of light waves. Scattered electrons were detected by an electron detector and the current was measured with the help of a galvanometer. By moving the detector on a circular scale that is by changing the scattering angle θ (angle between the incident and the scattered electron beams), the intensity of the scattered electron beam was measured for different values of scattering angle. Scattered intensity was not found to be uniform in all directions (as predicted by classical theory). The intensity pattern resembled a diffraction pattern with peaks corresponding to constructive interference and troughs to regions of destructive interference. Diffraction is a property of waves. Hence, above observations implied that the electrons formed a diffraction pattern on scattering and that particles could show wave-like properties.

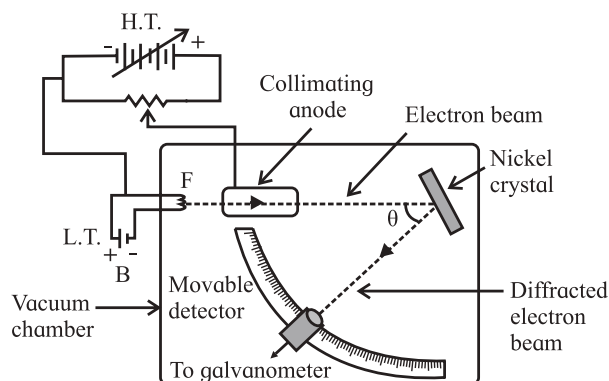

Fig. 14.8: Schematic of Davisson and Germer experiment.

Davisson and Germer varied the accelerating potential from 44 V to 68 V and observed a peak in the intensity of the scattered electrons at scattering angle of 50° for a potential of 54 V. This peak was the result of constructive interference of the electrons scattered from different layers of the regularly spaced atoms of the nickel crystal.

From Eq. (14.7), for $V = 54$ V, we get

$$\lambda = 1.228/\sqrt{54} = 0.167 \text{ nm} \quad \text{--- (14.8)}$$

From the electron diffraction measurements, the wavelength of matter waves associated with the electrons was found to be 0.165 nm. The two values of λ ,

obtained from the experimental results and from the theoretical de Broglie relation, were in close agreement. The Davisson and Germer experiment thus substantiated de Broglie's hypothesis of wave-particle duality and verified his relation.



Use your brain power

Diffraction results described above can be produced in the laboratory using an electron diffraction tube as shown in figure. It has a filament which on heating produces electrons. This filament acts as a cathode. Electrons are accelerated to quite high speeds by creating large potential difference between the cathode and a positive electrode. On its way, the beam of electrons comes across a thin sheet of

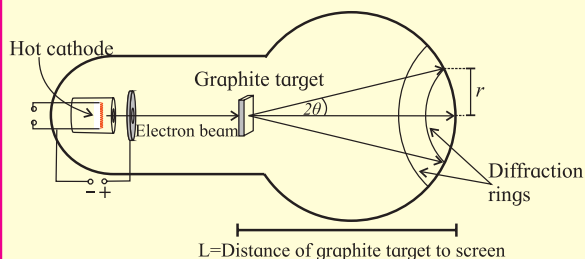

graphite. The electrons are diffracted by the atomic layers in the graphite and form diffraction rings on the phosphor screen. By changing the voltage between the cathode and anode, the energy, and therefore the speed, of the electrons can be changed. This will change the wavelength of the electrons and a change will be seen in the diffraction pattern. **By increasing the voltage, the radius of the diffraction rings will decrease. Try to explain why?**

14.7 Wave-Particle Duality of Matter:

Material particles show wave-like nature under certain circumstances. This phenomenon is known as **wave-particle duality of matter**. Frequency ω and wave number k are used to describe waves in classical theories while mass m and momentum p are used to describe

particles. Wave-particle duality implies that all moving particles have an associated frequency and an associated wave number and all waves have an associated energy and an associated momentum. We come across the wave-particle duality of matter due to quantum behaviour when we are dealing with microscopic objects (sizes $\leq 10^{-6}$ m). Small order of magnitude of h sets the scale at which quantum phenomena manifest themselves.

If all the material objects in motion have an associated wavelength (and therefore an associated wave), why then we do not talk about wavelength of a child running with speed v on a pathway 2 m wide or a car moving with speed v on a road 20 m wide? To understand this, let us try to calculate these quantities.

Example 14.5: A student, weighing 45 kg, is running with a speed of 8 km per hr on a foot path 2 m wide. A small car, weighing 1200 kg, is moving with a speed of 60 km per hr on a 20 m wide road. Calculate their de Broglie wavelengths.

Solution : Given

$$v_1 = 8 \text{ km/hr} = 8 \times 10^3 / 3600 \text{ m/s and}$$

$$m_1 = 45 \text{ kg for the student,}$$

$$v_2 = 60 \text{ km/hr} = 60 \times 10^3 / 3600 \text{ m/s and}$$

$$m_2 = 1200 \text{ kg for the car,}$$

$$\text{momentum } p_1 = 45 \times 8 \times 10^3 / 3600$$

$$= 100 \text{ kg m/s for the student and}$$

$$\text{momentum } p_2 = 1200 \times 60 \times 10^3 / 3600$$

$$= 20000 \text{ kg m/s for the car.}$$

The de Broglie wavelength

$$\lambda_1 = h/p_1 = 6.63 \times 10^{-34} \text{ J s} / 100 \text{ kg m/s}$$

$$= 6.63 \times 10^{-36} \text{ m. for the student, and}$$

de Broglie wavelength

$$\lambda_2 = h/p_2 = 6.63 \times 10^{-34} \text{ J s} / 20000 \text{ kg m/s}$$

$$= 3.32 \times 10^{-38} \text{ m for the car.}$$

The wavelengths calculated in example 14.5 are negligible compared to the size of the moving objects as well as to the widths of the paths on which the objects are moving.

Therefore the wavelengths associated with macroscopic particles do not play any significant role in our everyday life and we need not consider their wave nature. Also the wavelengths for macroscopic particles are so small that they cannot be measured.

On the other hand, if we try to estimate the associated de Broglie wavelength of a moving electron passing through a small aperture of size 10^{-10} m or an oxygen molecule in air, we will find it to be significant as can be seen in the following example.

Example 14.6: Calculate the de Broglie wavelength of an electron moving with kinetic energy of 100 eV passing through a circular hole of diameter 2 \AA .

Solution: Given

$$E_K = 100 \text{ eV} = 100 \times 1.6 \times 10^{-19} \text{ J.}$$

The speed of the electron is given by the relation $\frac{1}{2} mv^2 = 100 \times 1.6 \times 10^{-19} \text{ J.}$

$$\therefore v = \sqrt{\frac{2 \times 100 \times 1.6 \times 10^{-19} \text{ J}}{9.11 \times 10^{-31} \text{ kg}}}$$

$$= 0.593 \times 10^7 \text{ m/s and}$$

$$\text{momentum } p = 9.11 \times 10^{-31} \text{ kg} \times 0.593 \times 10^7 \text{ m/s} = 5.40 \times 10^{-24} \text{ kg m/s}$$

$$\therefore \text{ the de Broglie wavelength } \lambda = h/p \\ = 6.63 \times 10^{-34} \text{ J s} / 5.40 \times 10^{-24} \text{ kg m/s} \\ = 1.23 \times 10^{-10} \text{ m} = 1.23 \text{ \AA.}$$

The wavelength of the electron in above example is comparable to the size of the hole through which the electron is passing. The wavelength associated with this electron is same as the size of a helium atom and more than double the size of a hydrogen atom.



Use your brain power

On what scale or under which circumstances is the wave nature of matter apparent?

Photon picture allows transfer of energy and momentum in the same manner as in Newtonian mechanics. Wave nature does not modify that. Whenever wavelengths are small compared to the dimensions of slits or

obstacles, or are not measurable, we can use Newtonian mechanics.

In conclusion, for both electromagnetic radiation and atomic and sub-atomic particles, particle nature is dominant during their interaction with matter. On the other hand, while traveling through space, particularly when their confinement is of same order of magnitude as their associated wavelength, the wave nature is dominant.



Do you know?

We have seen earlier that electrons are bound inside a metal surface and need some minimum energy equal to the work function to be knocked off from the surface. This energy, if provided by any means, can make the electron come out of the metal surface. Physical ways to provide this energy differentiate the physical processes involved and accordingly different devices and characterizing microscopes based on them have been designed by scientists.

- Thermionic emission : By heating to temperatures $\sim 2000 \text{ }^\circ\text{C}$ provide thermal energy.
- Field emission : By establishing strong electric fields $\sim 10^6 \text{ V/m}$ at the surface of a metal tip, provide electrical energy.
- Photo-electron emission : By shining radiation of suitable frequency (ultraviolet or visible) on a metal surface provide light energy.

Electron microscope:

You have learnt about resolving power and resolution of telescopes and microscopes that use the ordinary visible light. The resolution of a microscope is limited by the wavelength of the light used. The shorter the wavelength of the characterizing probe, the smaller is the limit of resolution of a microscope, i.e., the resolution of microscope is better. Better

resolution can be attained by illuminating the objects to be seen by radiation of smaller wavelengths. We have seen that an electron can behave as a wave and its wavelength is much smaller than the wavelength of visible light. The wavelength can be made much smaller as it depends on the velocity and kinetic energy of the electron. An electron beam accelerated to several keV of energy will correspond to de Broglie wavelength much smaller than an angstrom, i.e., $\lambda_e \ll 1 \times 10^{-10}$ m. The resolution of this electron microscope will be several hundred times higher than that obtainable with an optical microscope.

Other advantages of electron microscopes are that (i) electrons do not penetrate the matter as visible light or X-rays do, (ii) electron beams can be more easily produced and controlled by electric and magnetic fields than electromagnetic waves and (iii) electrons can be focused like light is focused with lenses.

It was proposed in 1925 that atoms in the solids can act as diffraction centers for electron waves and can give information about the geometry or structure of solid, just as X-rays do on getting diffracted by solids. However, it took many years to realize an electron microscope for practical applications. The first electron microscope was developed by Herald Ruska in Berlin, Germany in the year 1929.

Microscopic objects, when illuminated using electron beams, yield high resolution images. Images of microscopic and nanometric objects and even of viruses have been obtained by scientists using electron microscopes, making valuable contributions to mankind.

Transmission electron microscopy can resolve very small particles. A micrograph

on the cover page of this book shows tiny crystals of dimensions less than 50 nm. An electron diffraction pattern is also seen on the cover page (spot pattern). When an electron beam passes through a crystal having periodic arrangement of atoms, diffraction occurs. The crystal acts as a collection of diffraction slits for the electron beam.



Internet my friend

1. <http://phet-web.colorado.edu/simulations/schrodinger/dg.jnlp>
2. <https://physics.info/photoelectric/>
3. <https://www.britannica.com/science/photoelectric-effect>
4. <https://www.britannica.com/science/wave-particle-duality>
5. https://www.sciencedaily.com/terms/wave-particle_duality.htm
6. <https://www.thoughtco.com/de-broglie-hypothesis-2699351>
7. <https://www.toppr.com/guides/physics/dual-nature-of-radiation-and-matter>
8. <http://hyperphysics.phy-astr.gsu.edu/hbase/quantum/DavGer2.html>



Exercises

1. Choose the correct answer.

- i) A photocell is used to automatically switch on the street lights in the evening when the sunlight is low in intensity. Thus it has to work with visible light. The material of the cathode of the photo cell is
 (A) zinc (B) aluminum
 (C) nickel (D) potassium
- ii) Polychromatic (containing many different frequencies) radiation is used in an experiment on photoelectric effect. The stopping potential
 (A) will depend on the average wavelength
 (B) will depend on the longest wavelength
 (C) will depend on the shortest wavelength
 (D) does not depend on the wavelength
- iii) An electron, a proton, an α -particle and a hydrogen atom are moving with the same kinetic energy. The associated de Broglie wavelength will be longest for
 (A) electron (B) proton
 (C) α -particle (D) hydrogen atom
- iv) If N_{Red} and N_{Blue} are the number of photons emitted by the respective sources of equal power and equal dimensions in unit time, then
 (A) $N_{\text{Red}} < N_{\text{Blue}}$ (B) $N_{\text{Red}} = N_{\text{Blue}}$
 (C) $N_{\text{Red}} > N_{\text{Blue}}$ (D) $N_{\text{Red}} \approx N_{\text{Blue}}$
- v) The equation $E = pc$ is valid
 (A) for all sub-atomic particles
 (B) is valid for an electron but not for a photon
 (C) is valid for a photon but not for an electron
 (D) is valid for both an electron and a photon

2. Answer in brief.

- i) What is photoelectric effect?
- ii) Can microwaves be used in the experiment on photoelectric effect?
- iii) Is it always possible to see photoelectric effect with red light?
- iv) Using the values of work function given in Table 14.1, tell which metal will require the highest frequency of incident radiation to generate photocurrent.
- v) What do you understand by the term wave-particle duality? Where does it apply?
3. Explain the inverse linear dependence of stopping potential on the incident wavelength in a photoelectric effect experiment.
4. It is observed in an experiment on photoelectric effect that an increase in the intensity of the incident radiation does not change the maximum kinetic energy of the electrons. Where does the extra energy of the incident radiation go? Is it lost? State your answer with explanatory reasoning.
5. Explain what do you understand by the de Broglie wavelength of an electron. Will an electron at rest have an associated de Broglie wavelength? Justify your answer.
6. State the importance of Davisson and Germer experiment.
7. What will be the energy of each photon in monochromatic light of frequency 5×10^{14} Hz?
 [Ans : 3.31×10^{-19} J = 2.07 eV]
8. Observations from an experiment on photoelectric effect for the stopping potential by varying the incident frequency were plotted. The slope of the linear curve was found to be approximately 4.1×10^{-15} V s. Given that

the charge of an electron is 1.6×10^{-19} C, find the value of the Planck's constant h .

[Ans : 6.56×10^{-34} J s]

9. The threshold wavelength of tungsten is 2.76×10^{-5} cm. (a) Explain why no photoelectrons are emitted when the wavelength is more than 2.76×10^{-5} cm. (b) What will be the maximum kinetic energy of electrons ejected in each of the following cases (i) if ultraviolet radiation of wavelength $\lambda = 1.80 \times 10^{-5}$ cm and (ii) radiation of frequency 4×10^{15} Hz is made incident on the tungsten surface.

[Ans: 2.40 eV, 12.07 eV]

10. Photocurrent recorded in the micro ammeter in an experimental set-up of photoelectric effect vanishes when the retarding potential is more than 0.8 V if the wavelength of incident radiation is 4950 Å. If the source of incident radiation is changed, the stopping potential turns out to be 1.2 V. Find the work function of the cathode material and the wavelength of the second source.

[Ans: 1.71 eV, 4270 Å]

11. Radiation of wavelength 4500 Å is incident on a metal having work function 2.0 eV. Due to the presence of a magnetic field B, the most energetic photoelectrons emitted in a direction perpendicular to the field move along a circular path of radius 20 cm. What is the value of the magnetic field B?

[Ans. : 1.47×10^{-5} T]

12. Given the following data for incident wavelength and the stopping potential obtained from an experiment on photoelectric effect, estimate the value of Planck's constant and the work function of the cathode material. What is the threshold frequency and corresponding wavelength? What is the most likely metal used for emitter?

Incident wavelength (in Å)	2536	3650
Stopping potential (in V)	1.95	0.5

[Ans: 6.42×10^{-34} J s, 2.80 eV,

6.76×10^{14} Hz, 4440 Å, calcium]

13. Calculate the wavelength associated with an electron, its momentum and speed (a) when it is accelerated through a potential of 54 V,

[Ans: 0.167 nm, 39.70×10^{-25} kg m s⁻¹, 4.36×10^6 m s⁻¹]

- (b) when it is moving with kinetic energy of 150 eV.

[Ans: 0.100 nm, 66.13×10^{-25} kg m s⁻¹, 7.26×10^6 m s⁻¹]

14. The de Broglie wavelengths associated with an electron and a proton are same. What will be the ratio of (i) their momenta (ii) their kinetic energies?

[Ans: 1, 1836]

15. Two particles have the same de Broglie wavelength and one is moving four times as fast as the other. If the slower particle is an α -particle, what are the possibilities for the other particle?

[Ans: proton or neutron]

16. What is the speed of a proton having de Broglie wavelength of 0.08 Å?

[Ans: 49.57×10^3 m s⁻¹]

17. In nuclear reactors, neutrons travel with energies of 5×10^{-21} J. Find their speed and wavelength.

[Ans: 2.45×10^3 m s⁻¹, 1.62 Å]

18. Find the ratio of the de Broglie wavelengths of an electron and a proton when both are moving with the (a) same speed, (b) same energy and (c) same momentum? State which of the two will have the longer wavelength in each case? [Ans: (a) 1836, (b) electron; 42.85, electron; (c) 1, equal]

15. Structure of Atoms and Nuclei



Can you recall?

1. What is Dalton's atomic model?
2. What are atoms made of?
3. What is wave particle duality?
4. What are matter waves?

15.1. Introduction:

Greek philosophers Leucippus (-370 BC) and Democritus (460 – 370 BC) were the first scientists to propose, in the 5th century BC, that matter is made of indivisible parts called atoms. Dalton (1766-1844) gave his atomic theory in early nineteenth century. According to his theory (i) matter is made up of indestructible particles, (ii) atoms of a given element are identical and (iii) atoms can combine with other atoms to form new substances. That atoms were indestructible was shown to be wrong by the experiments of J. J. Thomson (1856-1940) who discovered electrons in 1887. He then proceeded to give his atomic model which had some deficiencies and was later improved upon by Ernest Rutherford (1871-1937) and Niels Bohr (1885-1962). We will discuss these different models in this Chapter. You have already studied about atoms and nuclei in XIth Std. in chemistry. This chapter will enable you to consolidate your concepts in this subject.

We will learn that, an atom contains a tiny nucleus whose size (radius) is about 100000 times smaller than the size of an atom. The nucleus contains all the positive charge of the atom and also 99.9% of its mass. In this Chapter we will also study properties of the nucleus, the forces that keep it intact, its radioactive decays and about the energy that can be obtained from it.

15.2. Thomson's Atomic Model:

Thomson performed several experiments with glass vacuum tube wherein a voltage

was applied between two electrodes inside an evacuated tube. The cathode was seen to emit rays which produced a glow when they struck the glass behind the anode. By studying the properties of these rays, he concluded that the rays are made up of negatively charged particles which he called electrons. This demonstrated that atoms are not indestructible. They contain electrons which are emitted by the cathode.

Thomson proposed his model of an atom in 1903. According to this model an atom is a sphere having a uniform positive charge in which electrons are embedded. This model is referred to as Plum-pudding model. The total positive charge is equal to the total negative charge of electrons in the atom, rendering it electrically neutral. As the whole solid sphere is uniformly positively charged, the positive charge cannot come out and only the negatively charged electrons which are small, can be emitted. The model also explained the formation of ions and ionic compounds. However, further experiments on structure of atoms which are described below, showed the distribution of charges to be very different than what was proposed in Thomson's model.

15.3 Geiger-Marsden Experiment:

In order to understand the structure of atoms, Rutherford suggested an experiment for scattering of alpha particles by atoms. Alpha particles are helium nuclei and are positively charged (having charge of two protons). The experiment was performed by his colleagues Geiger (1882-1945) and Marsden (1889-1970) between 1908 and 1913. A sketch of the experimental set up is shown in Fig.15.1.

Alpha particles from a source were collimated, i.e., focused into a narrow beam, and were made to fall on a gold foil. The scattered particles produced scintillations on the

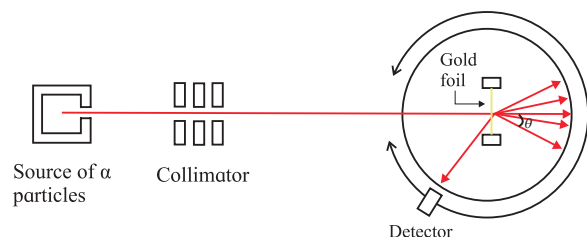

Fig.15.1: Geiger-Marsden experiment.

surrounding screen. The scintillations could be observed through a microscope which could be moved to cover different angles with respect to the incident beam. It was found that most alpha particles passed straight through the foil while a few were deflected (scattered) through various scattering angles. A typical scattering angle is shown by θ in the figure. Only about 0.14% of the incident alpha particles were scattered through angles larger than 0.1° . Even out of these, most were deflected through very small angles. About one alpha particle in 8000 was deflected through angle larger than 90° and a fewer still were deflected through angles as large as 180° .

15.4. Rutherford's Atomic Model:

Results of Geiger-Marsden's experiment could not be explained by Thomson's model. In that model, the positive charge was uniformly spread over the large sphere constituting the atom. The volume density of the positive charge would thus be very small and all of the incident alpha particles would get deflected only through very small angles. Rutherford argued that the alpha particles which were deflected back must have encountered a massive particle with large positive charge so that it was repelled back. From the fact that extremely small number of alpha particles turned back while most others passed through almost undeflected, he concluded that the positively charged particle in the atom must be very small in size and must contain most of the mass of the atom. From the experimental data, the size of this particle was found to be about 10 fm (femtometre, 10^{-15}) which is about 10^{-5} times the size of the atom. The volume of

this particle was thus found to be about 10^{-15} times that of an atom. He called this particle the nucleus of an atom.

He proposed that the entire positive charge and most (99.9%) of the mass of an atom is concentrated in the central nucleus and the electrons revolve around it in circular orbits, similar to the revolution of the planets around the Sun in the Solar system. The revolution of the electrons was necessary as without it, the electrons would fall into the positively charged nucleus and the atom would collapse. The space between the orbits of the electrons (which decide the size of the atom) and the nucleus is mostly empty. Thus, most alpha particles pass through this empty space undeflected and a very few which are in direct line with the tiny nucleus or are extremely close to it, get repelled and get deflected through large angles. This model also explains why no positively charged particles are emitted by atoms while negatively charged electrons are. This is because of the large mass of the nucleus which does not get affected when force is applied on the atom.

15.4.1. Difficulties with Rutherford's Model:

Though this model in its basic form is still accepted, it faced certain difficulties. We know from Maxwell's equations that an accelerated charge emits electromagnetic radiation. An electron in Rutherford's model moves uniformly along a circular orbit around the nucleus. Even though the magnitude of its velocity is constant, its direction changes continuously and so the motion is an accelerated motion. Thus, the electron should emit electromagnetic radiation continuously. Also, as it emits radiation, its energy would decrease and consequently, the radius of its orbit would decrease continuously. It would then spiral into the nucleus, causing the atom to collapse and lose its atomic properties. As the electron loses energy, its velocity changes continuously and the frequency of the radiation emitted would also change continuously as

it moves towards the nucleus. None of these things are observed. Firstly, most atoms are very stable and secondly, they do not constantly emit electromagnetic radiation and definitely not of varying frequency. The atoms have to be given energy, e.g., by heating, for them to be able to emit radiation and even then, they emit electromagnetic radiations of particular frequencies as will be seen in the next section. Rutherford's model failed on all these counts.

15.5 Atomic Spectra:

We know that when a metallic object is heated, it emits radiation of different wavelengths. When this radiation is passed through a prism, we get a continuous spectrum. However, the case is different when we heat hydrogen gas inside a glass tube to high temperatures. The emitted radiation has only a few selected wavelengths and when passed through a prism we get what is called a line spectrum as shown for the visible range in Fig.15.2. It shows that hydrogen emits radiations of wavelengths 410, 434, 486 and 656 nm and does not emit any radiation with wavelengths in between these wavelengths. The lines seen in the spectrum are called emission lines.

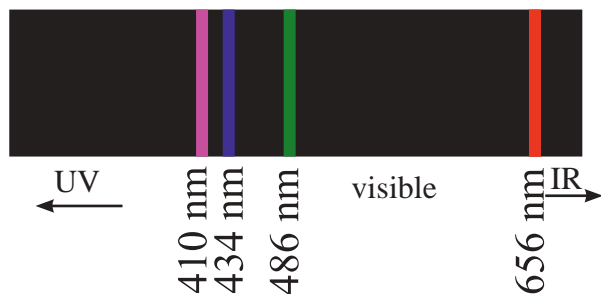

Fig.15.2: Hydrogen spectrum.

Hydrogen atom also emits radiation at some other values of wavelengths in the ultraviolet (UV), the infrared (IR) and at longer wavelengths. The spectral lines can be divided into groups known as series with names of the scientists who studied them. The series, starting from shorter wavelengths and going to larger wavelengths are called Lyman

series, Balmer series, Paschen series, Brackett series, Pfund series, etc. In each series, the separation between successive lines decreases as we go towards shorter wavelength and they reach a limiting value.

Schematic diagrams for the first three series are shown in Fig.15.3. The limiting value of the wavelength for each series is shown by dotted lines in the figure.

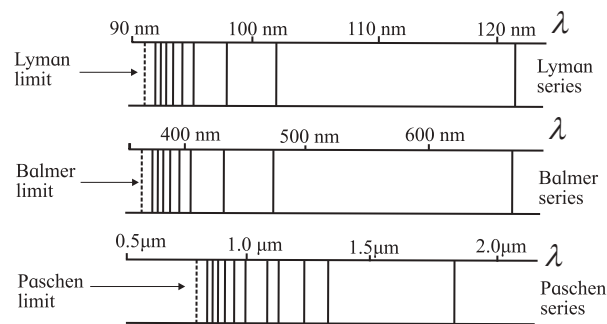

Fig.15.3: Lyman, Balmer and Paschen series in hydrogen spectrum.

The observed wavelengths of the emission lines are found to obey the relation.

$$\frac{1}{\lambda} = R \left[\frac{1}{n^2} - \frac{1}{m^2} \right] \quad \text{--- (15.1)}$$

Here λ is the wavelength of a line, R is a constant and n and m are integers. $n = 1, 2, 3, \dots$ respectively, for Lyman, Balmer, Paschen... series, while m takes all integral values greater than n for that series. The wavelength decreases with increase in m .

The difference in wavelengths of successive lines in each series (fixed value of n) can be calculated from Eq. (15.1) and shown to decrease with increase in m . Thus, the successive lines in a given series come closer and closer and ultimately reach the values of $\lambda = \frac{n^2}{R}$ in the limit $m \rightarrow \infty$, for different values of n . Atoms of other elements also emit line spectra. The wavelengths of the lines emitted by each element are unique, so much so that we can identify the element from the wavelengths of the spectral lines that it emits. Rutherford's model could not explain the atomic spectra.

15.6. Bohr's Atomic Model:

Niels Bohr modified Rutherford's model by applying ideas of quantum physics which were being developed at that time. He realized that Rutherford's model is essentially correct and all that it needs is stability of the orbits. Also, the electrons in these stable orbits should not emit electromagnetic waves as required by classical (Maxwell's) electromagnetic theory. He made three postulates which defined his atomic model. These are given below.

1. The electrons revolve around the nucleus in circular orbits.

This is the same assumption as in Rutherford's model and the centripetal force necessary for the circular motion is provided by the electrostatic force of attraction between the electron and the nucleus.

2. The radius of the orbit of an electron can only take certain fixed values such that the angular momentum of the electron in these orbits is an integral multiple of $h/2\pi$, h being the Planck's constant.

Such orbits are called stable orbits or stable states of the electrons and electrons in these orbits do not emit radiation as is demanded by classical physics. Thus, different orbits have different and definite values of angular momentum and therefore, different values of energies.

3. An electron can make a transition from one of its orbit to another orbit having lower energy. In doing so, it emits a photon of energy equal to the difference in its energies in the two orbits.**15.6.1. Radii of the Orbits:**

Using first two postulates we can study the entire dynamics of the circular motion of the electron, including its energy. Let the mass of the electron be m_e , its velocity in the n^{th} stable orbit be v_n and the radius of its orbit be r_n . The angular momentum is then $m_e v_n r_n$ and according to the second postulate above, we can write

$$m_e v_n r_n = n \frac{h}{2\pi} \quad \text{--- (15.2)}$$

The positive integer n is called the *principal quantum number* of the electron. The centripetal force necessary for the circular motion of the electron is provided by the electrostatic force of attraction between the electron and the nucleus. Assuming the atomic number (number of electrons) of the atom to be Z , the total positive charge on the nucleus is Ze and we can write,

$$\frac{m_e v_n^2}{r_n} = \frac{Ze^2}{4\pi\epsilon_0 r_n^2} \quad \text{--- (15.3)}$$

Here, ϵ_0 is the permeability of vacuum and e is the electron charge. Eliminating v_n from the Eq.(15.2) and Eq.(15.3), we get,

$$\frac{m_e n^2 h^2}{4\pi^2 m_e^2 r_n^3} = \frac{Ze^2}{4\pi\epsilon_0 r_n^2}$$

$$\therefore r_n = \frac{n^2 h^2 \epsilon_0}{\pi m_e Ze^2} \quad \text{--- (15.4)}$$

Similarly, eliminating r_n from Eq.(15.2) and Eq.(15.3), we get,

$$v_n = \frac{Ze^2}{2\epsilon_0 h n} \quad \text{--- (15.5)}$$

Equation (15.4) shows that the radius of the orbit is proportional to n^2 , i.e., the square of the principal quantum number. The radius increases with increase in n . The hydrogen atom has only one electron, i.e., Z is 1. Substituting the values of the constants h , ϵ_0 , m and e in Eq.(15.4), we get, for $n = 1$, $r_1 = 0.053$ nm. This is called the Bohr radius and is denoted by $a_0 = \frac{h^2 \epsilon_0}{\pi m_e e^2}$.

This is the radius of the smallest orbit of the electron in hydrogen atom. From Eq. (15.4), we can write,

$$r_n = a_0 n^2 \quad \text{--- (15.6)}$$

Example 15.1: Calculate the radius of the 3rd orbit of the electron in hydrogen atom.

Solution: The radius of n^{th} orbit is given by $r_n = a_0 n^2$. Thus, the radius of the third orbit ($n = 3$) is

$$r_3 = a_0 3^2 = 9a_0 = 9 \times 0.053 \text{ nm} = 0.477 \text{ nm}.$$

Example 15.2: In a Rutherford scattering experiment, assume that an incident alpha particle (radius 1.80 fm) is moving directly toward a target gold nucleus (radius 6.23 fm). If the alpha particle stops right at the surface of the gold nucleus, how much energy did it have to start with?

Solution: Initially when the alpha particle is far away from the gold nucleus, its total energy is equal to its kinetic energy. As it comes closer to the nucleus, more and more of its kinetic energy gets converted to potential energy. By the time it reaches the surface of the nucleus, its kinetic energy is completely converted into potential energy and it stops moving. Thus, the initial kinetic energy K , of the alpha particle is equal to the potential energy when it is at the surface of the nucleus, i.e., when the distance between the gold nucleus and the alpha particle is equal to the radius of the gold nucleus.

$\therefore K = \frac{1}{4\pi\epsilon_0} \frac{2eZe}{(r_1 + r_2)}$, where, Z is the atomic number of gold and r_1 and r_2 are the radii of the gold nucleus and alpha particle respectively. For gold $Z = 79$.

$$\begin{aligned} \therefore K &= \frac{1}{4\pi\epsilon_0} \frac{2Ze^2}{(r_1 + r_2)} \\ &= 9 \times 10^9 \frac{2 \times 79 \times (1.6 \times 10^{-19})^2}{(6.23 + 1.80) \times 10^{-15}} \\ &= 4.53 \times 10^{-12} \text{ J} = 28.31 \text{ MeV} \end{aligned}$$

15.6.2. Energy of the Electrons:

The total energy of an orbiting electron is the sum of its kinetic energy and its electrostatic potential energy. Thus,

$E_n = K.E. + P.E.$, E_n being the total energy of an electron in the n^{th} orbit.

$$E_n = \frac{1}{2} m_e v_n^2 + \left(-\frac{Ze^2}{4\pi\epsilon_0 r_n} \right).$$

Using Eq. (15.3) and (15.4) this gives

$$E_n = -\frac{m_e Z^2 e^4}{8\epsilon_0 h^2 n^2} \quad \text{--- (15.7)}$$

The negative value of the energy of the electron indicates that the electron is bound inside the atom and it has to be given energy so as to make the total energy zero, i.e., to make the electron free from the nucleus. The energy increases (becomes less negative) with increase in n . Substituting the values of the constants m, e, h and ϵ_0 in the above equation, we get

$$E_n = -13.6 \frac{Z^2}{n^2} \text{ eV} \quad \text{--- (15.8)}$$

The first orbit ($n=1$) which has minimum energy, is called the **ground state** of the atom. Orbits with higher values of n and therefore, higher values of energy are called the **excited states** of the atom. If the electron is in the n^{th} orbit, it is said to be in the n^{th} energy state. For hydrogen atom ($Z=1$) the energy of the electron in its ground state is -13.6 eV and the energies of the excited states increase as given by Eq.(15.8). The energy levels of hydrogen atom are shown in Fig.15.4. The energies of the levels are given in eV.

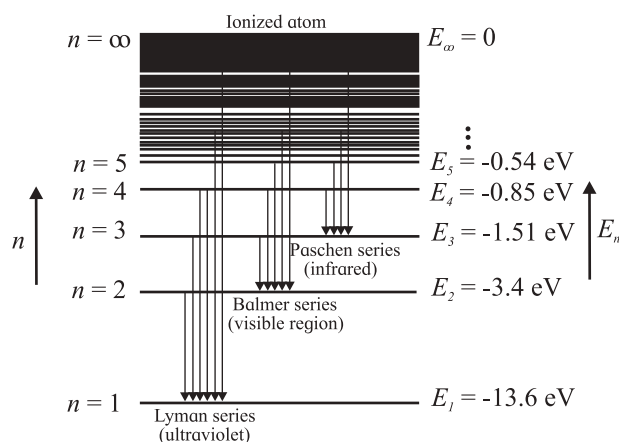

Fig.15.4: Energy levels and transitions between them for hydrogen atom (energy not to scale).

The energy levels come closer and closer as n increases and their energy reaches a limiting value of zero as n goes to infinity. The energy required to take an electron from the ground state to an excited state is called the **excitation energy** of the electron in that state. For hydrogen atom, the minimum excitation energy (of $n=2$ state) is $-3.4 - (-13.6) = 10.2$ eV.

In order to remove or take out the electron in the ground state from a hydrogen atom, i.e., to make it free (and have zero energy), we have to supply 13.6 eV energy to it. This energy is called the **ionization energy** of the hydrogen atom. **The ionization energy of an atom is the minimum amount of energy required to be given to an electron in the ground state of that atom to set the electron free.** It is the **binding energy** of hydrogen atom. If we form a hydrogen atom by bringing a proton and an electron from infinity and combine them, 13.6 eV energy will be released.

According to the third postulate of Bohr, when an electron makes a transition from m^{th} to n^{th} orbit ($m > n$), the excess energy $E_m - E_n$ is emitted in the form of a photon. The energy of the photon which can be written as $h\nu$, ν being its frequency, is therefore given by,

$h\nu = \frac{m_e Z^2 e^4}{8 \epsilon_0 \hbar^2} \left(\frac{1}{n^2} - \frac{1}{m^2} \right)$ which can be written in terms of the wavelength as

$$\frac{1}{\lambda} = \frac{m_e Z^2 e^4}{8 c \epsilon_0 \hbar^3} \left(\frac{1}{n^2} - \frac{1}{m^2} \right) \quad \text{---(15.9)}$$

Here c is the velocity of light in vacuum. We define a constant called the **Rydberg's constant**, R_H as

$$R_H = \frac{m_e e^4}{8 c \epsilon_0 \hbar^3} = 1.097 \times 10^7 \text{ m}^{-1}. \quad \text{---(15.10)}$$

In terms of R , the wavelength is given by

$$\frac{1}{\lambda} = R_H Z^2 \left(\frac{1}{n^2} - \frac{1}{m^2} \right) \quad \text{---(15.11)}$$

This is called the **Rydberg's formula**. Remember that for hydrogen Z is 1. Thus, Eq.(15.11) correctly describes the observed spectrum of hydrogen as given by Eq.(15.1).

Example 15.3: Determine the energies of the first two excited states of the electron in hydrogen atom. What are the excitation energies of the electrons in these orbits?

Solution: The energy of the electron in the n^{th} orbit is given by $E_n = -13.6 \frac{1}{n^2} \text{ eV}$.

The first two excited states have $n = 2$ and 3. Their energies are

$$E_2 = -13.6 \frac{1}{2^2} = -3.4 \text{ eV} \quad \text{and}$$

$$E_3 = -13.6 \frac{1}{3^2} = -1.51 \text{ eV}.$$

Excitation energy of an electron in n^{th} orbit is the difference between its energy in that orbit and the energy of the electron in its ground state, i.e. -13.6 eV. Thus, the excitation energies of the electrons in the first two excited states are 10.2 eV and 12.09 eV respectively.

Example 15.4: Calculate the wavelengths of the first three lines in Paschen series of hydrogen atom.

Solution: The wavelengths of lines in Paschen series ($n=3$) are given by

$$\frac{1}{\lambda} = R_H \left(\frac{1}{n^2} - \frac{1}{m^2} \right) = 1.097 \times 10^7 \left(\frac{1}{3^2} - \frac{1}{m^2} \right) \text{ m}^{-1} \text{ for } m = 4, 5, \dots$$

For the first three lines in the series, $m = 4, 5$ and 6. Substituting in the above formula we get,

$$\begin{aligned} \frac{1}{\lambda_1} &= 1.097 \times 10^7 \left(\frac{1}{3^2} - \frac{1}{4^2} \right) \\ &= 1.097 \times 10^7 \times 7 / (9 \times 16) \\ &= 0.0533 \times 10^7 \text{ m}^{-1} \end{aligned}$$

$$\lambda_1 = 1.876 \times 10^{-6} \text{ m}$$

$$\begin{aligned} \frac{1}{\lambda_2} &= 1.097 \times 10^7 \left(\frac{1}{3^2} - \frac{1}{5^2} \right) \\ &= 1.097 \times 10^7 \times 16 / (9 \times 25) \\ &= 0.075 \times 10^7 \text{ m}^{-1} \end{aligned}$$

$$\lambda_2 = 1.282 \times 10^{-6} \text{ m}$$

$$\begin{aligned} \frac{1}{\lambda_3} &= 1.097 \times 10^7 \left(\frac{1}{3^2} - \frac{1}{6^2} \right) \\ &= 1.097 \times 10^7 \times 27 / (9 \times 36) \\ &= 0.0914 \times 10^7 \text{ m}^{-1} \end{aligned}$$

$$\lambda_3 = 1.094 \times 10^{-6} \text{ m}$$

15.6.3. Limitations of Bohr's Model:

Even though Bohr's model seemed to explain hydrogen spectrum, it had a few shortcomings which are listed below.

- (i) It could not explain the line spectra of atoms other than hydrogen. Even for hydrogen, more accurate study of the observed spectra showed multiple components in some lines which could not be explained on the basis of this model.
- (ii) The intensities of the emission lines seemed to differ from line to line and Bohr's model had no explanation for that.
- (iii) On theoretical side also the model was not entirely satisfactory as it arbitrarily assumed orbits following a particular condition to be stable. There was no theoretical basis for that assumption.

A full quantum mechanical study is required for the complete understanding of the structure of atoms which is beyond the scope of this book. Some reasoning for the third shortcoming (i.e., theoretical basis for the second postulate in Bohr's atomic model) was given by de Broglie which we consider next.

15.6.4 De Broglie's Explanation:

We have seen in Chapter 14 that material particles also have dual nature like that for light and there is a wave associated with every material particle. De Broglie suggested that instead of considering the orbiting electrons inside atoms as particles, we should view them as standing waves. Similar to the case of standing waves on strings or in pipes as studied in Chapter 6, the length of the orbit of an electron has to be an integral multiple of its wavelength. Thus, the length of the first orbit will be equal to one de Broglie wavelength, λ_1 of the electron in that orbit, that of the second orbit will be twice the de Broglie wavelength of the electron in that orbit and so on. This is shown for the 4th orbit in Fig.(15.5)

In general, we can write,

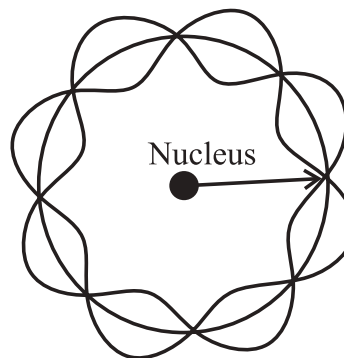

Fig. 15.5: Standing electron wave for the 4th orbit of an electron in an atom.

$2\pi r_n = n\lambda_n, n = 1, 2, 3, \dots$, giving

$$\lambda_n = \frac{2\pi r_n}{n} \quad \text{--- (15.12)}$$

The de Broglie wavelength is related to the linear momentum p_n , of the particle by

$$\lambda_n = \frac{h}{p_n} = \frac{h}{mv_n}$$

Substituting this in Eq. (15.12) gives,

$$p_n = \frac{hn}{2\pi r_n}$$

Thus, the angular momentum of the electron in n^{th} orbit, L_n , can be written as

$L_n = p_n r_n = n \frac{h}{2\pi}$, which is the second postulate of Bohr's atomic model. Therefore, considering electrons as waves gives some theoretical basis for the second postulate made by Bohr.

15.7. Atomic Nucleus:

15.7.1 Constituents of a Nucleus:

The atomic nucleus is made up of subatomic, meaning smaller than an atom, particles called **protons** and **neutrons**. Together, protons and neutrons are referred to as **nucleons**. Mass of a proton is about 1836 times that of an electron. Mass of a neutron is nearly same as that of a proton but is slightly higher. The proton is a positively charged particle. The magnitude of its charge is equal to the magnitude of the charge of an electron. The neutron, as the name suggests, is electrically neutral. The number of protons in an atom is called its **atomic number** and is designated by **Z**. The number of electrons

in an atom is also equal to Z . Thus, the total positive and total negative charges in an atom are equal in magnitude and the atom as a whole is electrically neutral. The number of neutrons in a nucleus is written as N . The total number of nucleons in a nucleus is called the **mass number** of the atom and is designated by $A = Z + N$. The mass number determines the mass of a nucleus and of the atom. The atoms of an element X are represented by the symbol for the element and its atomic and mass numbers as ${}^A_Z X$. For example, symbols for hydrogen, carbon and oxygen atoms are written as ${}^1_1\text{H}$, ${}^{12}_6\text{C}$ and ${}^{16}_8\text{O}$. The chemical properties of an atom are decided by the number of electrons present in it, i.e., by Z .

The number of protons and electrons in the atoms of a given element are fixed. For example, hydrogen atom has one proton and one electron, carbon atom has six protons and six electrons. The number of neutrons in the atoms of a given element can vary. For example, hydrogen nucleus can have zero, one or two neutrons. These varieties of hydrogen are referred to as ${}^1_1\text{H}$, ${}^2_1\text{H}$ and ${}^3_1\text{H}$ and are respectively called hydrogen, deuterium and tritium. Atoms having the same number of protons but different number of neutrons are called **isotopes**. Thus, deuterium and tritium are isotopes of hydrogen. They have the same chemical properties as those of hydrogen. Similarly, helium nucleus can have one or two neutrons and are referred as ${}^3_2\text{He}$ and ${}^4_2\text{He}$. The atoms having the same mass number A , are called **isobars**. Thus, ${}^3_1\text{H}$ and ${}^3_2\text{He}$ are isobars. Atoms having the same number of neutrons but different values of atomic number Z , are called **isotones**. Thus, ${}^3_1\text{H}$ and ${}^4_2\text{He}$ are isotones.

Units for measuring masses of atoms and subatomic particles

Masses of atoms and subatomic particles are measured in three different units. First unit is the usual unit kg. The masses of electron,

proton and neutron, m_e , m_p and m_n respectively, in this unit are:

$$m_e = 9.109383 \times 10^{-31} \text{ kg}$$

$$m_p = 1.672623 \times 10^{-27} \text{ kg}$$

$$m_n = 1.674927 \times 10^{-27} \text{ kg}$$

Obviously, kg is not a convenient unit to measure masses of atoms or subatomic particles which are extremely small compared to one kg. Therefore, another unit called the unified atomic mass unit (u) is used for the purpose. One u is equal to $1/12^{\text{th}}$ of the mass of a neutral carbon atom having atomic number 12, in its lowest electronic state. $1 \text{ u} = 1.6605402 \times 10^{-27} \text{ kg}$. In this unit, the masses of the above three particles are

$$m_e = 0.00055 \text{ u}$$

$$m_p = 1.007825 \text{ u}$$

$$m_n = 1.008665 \text{ u}.$$

The third unit for measuring masses of atoms and subatomic particles is in terms of the amount of energy that their masses are equivalent to. According to Einstein's famous mass-energy relation, a particle having mass m is equivalent to an amount of energy $E = mc^2$. The unit used to measure masses in terms of their energy equivalent is the eV/c^2 . One atomic mass unit is equal to $931.5 \text{ MeV}/c^2$. The masses of the three particles in this unit are

$$m_e = 0.511 \text{ MeV}/c^2$$

$$m_p = 938.28 \text{ MeV}/c^2$$

$$m_n = 939.57 \text{ MeV}/c^2$$

15.7.2. Sizes of Nuclei:

The size of an atom is decided by the sizes of the orbits of the electrons in the atom. Larger the number of electrons in an atom, higher are the orbits occupied by them and larger is the size of the atom. Similarly, all nuclei do not have the same size. Obviously, the size of a nucleus depends on the number of nucleons present in it, i.e., on its atomic number A . From experimental observations it has been found that the radius R_x of a nucleus ${}_Z^AX$ is related to A as

$$R_x = R_0 A^{\frac{1}{3}} \quad \text{--- (15.13)}$$

where $R_0 = 1.2 \times 10^{-15}$ m.

The density ρ inside a nucleus is given by $\frac{4}{3}\pi R^3 \rho = mA$, where, we have assumed m to be the average mass of a nucleon (proton and neutron) as the difference in their masses is rather small. The density is then given by,

$$\rho = \frac{3mA}{4\pi R_x^3}$$

Substituting for R_x from Eq.(15.13), we get,

$$\rho = \frac{3m}{4\pi R_0^3} = \text{constant.}$$

Thus, the density of a nucleus does not depend on the atomic number of the nucleus and is the same for all nuclei. Substituting the values of the constants m , π and R_0 the value of the density is obtained as 2.3×10^{17} kg m⁻³ which is extremely large. Among all known elements, osmium is known to have the highest density which is only 2.2×10^4 kg m⁻³. This is smaller than the nuclear density by thirteen orders of magnitude.

Example 15.5: Calculate the radius and density of ⁷⁰Ge nucleus, given its mass to be approximately 69.924 u.

Solution: The radius of a nucleus X with mass number A is given by $R_x = R_0 A^{\frac{1}{3}}$, where $R_0 = 1.2 \times 10^{-15}$ m

Thus, the radius of ⁷⁰Ge is

$$R_{Ge} = 1.2 \times 10^{-15} \times 70^{1/3} = 4.95 \times 10^{-15} \text{ m.}$$

The density is given by $\rho = \frac{3m}{4\pi R_0^3}$.

$$\begin{aligned} \therefore \rho &= 3 \times 69.924 \times 1.66 \times \frac{10^{-27}}{4\pi (4.95 \times 10^{-15})^3} \\ &= 2.29 \times 10^{17} \text{ kg m}^{-3}. \end{aligned}$$

15.7.3 Nuclear Forces:

You have learnt about the four fundamental forces that occur in nature. Out of these four, the force that determines the structure of the nucleus is the strong force, also called the nuclear force. This acts between protons and neutrons and is mostly attractive. It is different from the electrostatic and gravitational force in terms of its strength and range, i.e., the

distance up to which it is effective. Over short distances of about a few fm, the strength of the nuclear force is much higher than that of the other two forces. Its range is very small and its strength goes to zero when two nucleons are at a distance larger than a few fm. This is in contrast to the ranges of electrostatic and gravitational forces which are infinite.

The protons in the nucleus repel one another due to their similar (positive) charges. The nuclear forces between the nucleons counter the forces of electrostatic repulsion. As nuclear force is much stronger than the electrostatic force for the distances between nucleons in a typical nucleus, it overcomes the repulsive force and keeps the nucleons together, making the nucleus stable.

The nuclear force is not yet well understood. What we know about its properties can be summarized as follows.

1. It is the strongest force among subatomic particles. Its strength is about 50-60 times larger than that of the electrostatic force.
2. Unlike the electromagnetic and gravitational forces which act over large distances (their range is infinity), the nuclear force has a range of about a few fm and the force is negligible when two nucleons are separated by larger distances.
3. The nuclear force is independent of the charge of the nucleons, i.e., the nuclear force between two neutrons with a given separation is the same as that between two protons or between a neutron and a proton at the same separation.

15.8. Nuclear Binding Energy:

We have seen that in a hydrogen atom, the energy with which the electron in its ground state is bound to the nucleus (which is a single proton in this case) is 13.6 eV. This is the amount of energy which is released when a proton and an electron are brought from infinity to form the atom in its ground state. In other words, this is the amount of energy which

has to be supplied to the atom to separate the electron and the proton, i.e., to make them free. The protons and the neutrons inside a nucleus are also bound to one another. Energy has to be supplied to the nucleus to make the nucleons free, i.e., separate them and take them to large distances from one another. This energy is the **binding energy** of the nucleus. Same amount of energy is released if we bring individual nucleons from infinity to form the nucleus. Where does this released energy come from? It comes from the masses of the nucleons. The mass of a nucleus is smaller than the total mass of its constituent nucleons. Let the mass of a nucleus having atomic number Z and mass number A be M . It is smaller than the sum of masses of Z protons and $N (= A - Z)$ neutrons. We can write,

$$\Delta M = Z m_p + N m_n - M \quad \text{---(15.14)}$$

ΔM is called the **mass defect** of the nucleus. The binding energy E_B , of the nucleus is given by

$$E_B = \Delta M c^2 = (Z m_p + N m_n - M) c^2 \quad \text{---(15.15)}$$

On the right hand side of Eq.(15.15), we can add and subtract the mass of Z electrons which will enable us to use atomic masses in the calculation of binding energy. The Eq.(15.15) thus becomes

$$E_B = \left[(Z m_p + Z m_e) + N m_n - (M + Z m_e) \right] c^2$$

$$E_B = \left[Z m_H + N m_n - {}^A_Z M \right] c^2 \quad \text{---(15.16)}$$

Here, m_H is the mass of a hydrogen atom and ${}^A_Z M$ is the atomic mass of the element being considered. We will be using atomic masses in what follows, unless otherwise specified.

An important quantity in this regard is the binding energy per nucleon ($=E_B/A$) of a nucleus. This can be considered to be the average energy which has to be supplied to a nucleon to remove it from the nucleus and make it free. This quantity thus, allows us to compare the relative strengths with which nucleons are bound in a nucleus for different

species and therefore, compare their stabilities. Nuclei with higher values of E_B/A are more stable as compared to nuclei having smaller values of this quantity. Binding energy per nucleon for different values of A (i.e., for nuclei of different elements) are plotted in Fig.15.6.

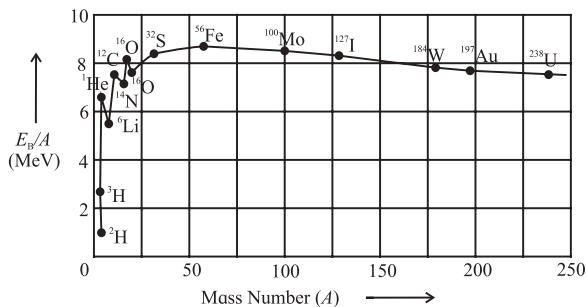

Fig.15.6: Binding energy per nucleon as a function of mass number.

Deuterium nucleus has the minimum value of E_B/A and is therefore, the least stable nucleus. The value of E_B/A increases with increase in atomic number and reaches a plateau for A between 50 to 80. Thus, the nuclei of these elements are the most stable among all the species. The peak occurs around $A = 56$ corresponding to iron, which is thus one of the most stable nuclei. The value of E_B/A decreases gradually for values of A greater than 80, making the nuclei of those elements slightly less stable. Note that the binding energy of hydrogen nucleus having a single proton is zero.

Example 15.6: Calculate the binding energy of ${}^7_3\text{Li}$, the masses of hydrogen and lithium atoms being 1.007825 u and 7.016 u respectively.

Solution: The binding energy is given by

$$E_B = (3 m_H + 4 m_n - m_{\text{Li}}) c^2$$

$$= (3 \times 1.007825 + 4 \times 1.00866 - 7.016) \times 931.5 = 39.23 \text{ MeV}$$

15.9 Radioactive Decays:

Many of the nuclei are stable, i.e., they can remain unchanged for a very long time. These have a particular ratio of the mass number and the atomic number. Other nuclei occurring in nature, are not so stable and undergo changes

in their structure by emission of some particles. They change or decay to other nuclei (with different A and Z) in the process. The decaying nucleus is called the **parent nucleus** while the nucleus produced after the decay is called the **daughter nucleus**. The process is called **radioactive decay** or **radioactivity** and was discovered by Becquerel (1852-1908) in 1876. Radioactive decays occur because the parent nuclei are unstable and get converted to more stable daughter nuclei by the emission of some particles. These decays are of three types as described below.

Alpha Decay: In this type of decay, the parent nucleus emits an alpha particle which is the nucleus of helium atom. The parent nucleus thus loses two protons and two neutrons. The decay can be expressed as

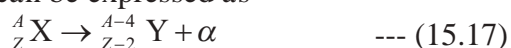

X is the parent nucleus and Y is the daughter nucleus. All nuclei with $A > 210$ undergo alpha decay. The reason is that these nuclei have a large number of protons. The electrostatic repulsion between them is very large and the attractive nuclear forces between the nucleons are not able to cope with it. This makes the nucleus unstable and it tries to reduce the number of its protons by ejecting them in the form of alpha particles. An example of this is the alpha decay of bismuth which is the parent nucleus with $A = 212$ and $Z = 83$. The daughter nucleus has $A = 208$ and $Z = 81$, which is thallium. The reaction is

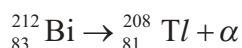

The total mass of the products of an alpha decay is always less than the mass of the parent atom. The excess mass appears as the kinetic energy of the products. The difference in the energy equivalent of the mass of the parent atom and that of the sum of masses of the products is called the Q -value, Q , of the decay and is equal to the kinetic energy of the products. We can write,

$$Q = [m_X - m_Y - m_{\text{He}}]c^2, \quad \text{--- (15.18)}$$

m_X , m_Y and m_{He} being the masses of the parent atom, the daughter atom and the helium atom. Note that we have used atomic masses to calculate the Q factor.



Do you know?

Becquerel discovered the radioactive decay by chance. He was studying the X-rays emitted by naturally occurring materials when exposed to Sunlight. He kept a photographic plate covered in black paper, separated from the material by a silver foil. When the plates were developed, he found images of the material on them, showing that the X-rays could penetrate the black paper and silver foil. Once while studying uranium-potassium phosphate in a similar way, the Sun was behind the clouds so no exposure to Sunlight was possible. In spite of this, he went ahead and developed the plates and found images to have formed. With further experimentation he concluded that some rays were emitted by uranium itself for which no exposure to Sunlight was necessary. He then passed the rays through magnetic field and found that the rays were affected by the magnetic field. He concluded that the rays must be charged particles and hence were different from the X-rays.

The term radioactivity was coined by Marie Curie who made further studies and later discovered element radium along with her husband. The Nobel Prize for the year 1903 was awarded jointly to Becquerel, Marie Curie and Pierre Curie for their contributions to radioactivity.

Beta Decay: In this type of decay the nucleus emits an electron produced by converting a neutron in the nucleus into a proton. Thus, the basic process which takes place inside the parent nucleus is



Neutrino and antineutrino are particles which

Example 15.7: Calculate the energy released in the alpha decay of ^{238}Pu to ^{234}U , the masses involved being $m_{\text{Pu}} = 238.04955$ u, $m_{\text{U}} = 234.04095$ u and $m_{\text{He}} = 4.002603$ u.

Solution: The decay can be written as $^{238}\text{Pu} \rightarrow ^{234}\text{U} + ^4\text{He}$. Its Q value, i.e., the energy released is given by

$$\begin{aligned} Q &= [m_{\text{Pu}} - m_{\text{U}} - m_{\text{He}}]c^2 \\ &= [238.04955 - 234.04095 - 4.002603]c^2 \text{ u} \\ &= 0.005997 \times 931.5 \text{ MeV} = 5.5862 \text{ MeV}. \end{aligned}$$

have very little mass and no charge. During beta decay, the number of nucleons i.e., the mass number of the nucleus remains unchanged. The daughter nucleus has one less neutron and one extra proton. Thus, Z increases by one and N decreases by one, A remaining constant. The decay can be written as,

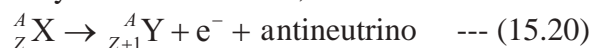

An example is

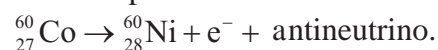

There is another type of beta decay called the **beta plus decay** in which a proton gets converted to a neutron by emitting a positron and a neutrino. A positron is a particle with the same properties as an electron except that its charge is positive. It is known as the antiparticle of electron. This decay can be written as,



The mass number remains unchanged during the decay but Z decreases by one and N increases by one. The decay can be written as

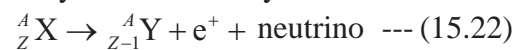

An example is

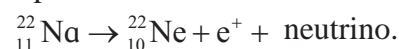

An interesting thing about beta plus decay is that the mass of a neutron is higher than the mass of a proton. Thus the decay described by Eq. (15.21) cannot take place for a free proton. However, it can take place when the proton is inside the nucleus as the extra energy needed to produce a neutron can be obtained from the rest of the nucleus.

In beta decay also, the total mass of the products of the decay is less than the mass of the parent atom. The excess mass is converted into kinetic energy of the products. The Q value for the decay can be written as

$$Q = [m_{\text{X}} - m_{\text{Y}} - m_{\text{e}}]c^2 \quad \text{--- (15.23)}$$

Here, we have ignored the mass of the neutrino as it is negligible compared to the masses of the nuclei.

Example 15.8: Calculate the maximum kinetic energy of the beta particle (positron) emitted in the decay of ${}^{22}_{11}\text{Na}$, given the mass of ${}^{22}_{11}\text{Na} = 21.994437$ u, ${}^{22}_{10}\text{Ne} = 21.991385$ u and $m_{\text{e}} = 0.00055$ u.

Solution: The decay can be written as ${}^{22}_{11}\text{Na} \rightarrow {}^{22}_{10}\text{Ne} + e^+ + \text{neutrino}$. The energy released is

$$\begin{aligned} Q &= [m_{\text{Na}} - m_{\text{Ne}} - m_{\text{e}}]c^2 \\ &= [21.994437 - 21.991385 - 0.00055]c^2 \\ &= 0.002502 \times 931.5 \text{ MeV} = 2.3306 \text{ MeV} \end{aligned}$$

This is the maximum energy that the beta particle (e^+) can have, the neutrino having zero energy in that case.

Gamma Decay: In this type of decay, gamma rays are emitted by the parent nucleus. As you know, gamma ray is a high energy photon. The daughter nucleus is same as the parent nucleus as no other particle is emitted, but it has less energy as some energy goes out in the form of the emitted gamma ray.

We have seen that the electrons in an atom are arranged in different energy levels (orbits) and an electron from a higher orbit can make a transition to the lower orbit emitting a photon in the process. The situation in a nucleus is similar. The nucleons occupy energy levels with different energies. A nucleon can make a transition from a higher energy level to a lower energy level, emitting a photon in the process. The difference between atomic and nuclear energy levels is in their energies and energy separations. Energies and the differences in the

energies of different levels in an atom are of the order of a few eVs, while those in the case of a nucleus are of the order of a few keV to a few MeV. Therefore, whereas the radiations emitted by atoms are in the ultraviolet to radio region, the radiations emitted by nuclei are in the range of gamma rays.

Usually, the nucleons in a nucleus are in the lowest possible energy state. They cannot easily get excited as a large amount of energy (in keVs or MeVs) is required for their excitation. A nucleon however may end up in an excited state as a result of the parent nucleus undergoing alpha or beta decay. Thus, gamma decays usually occur after one of these decays. For example, ^{57}Co undergoes beta plus decay to form the daughter nucleus ^{57}Fe which is in an excited state having energy of 136 keV. There are two ways in which it can make a transition to its ground state. One is by emitting a gamma ray of energy 136 keV and the other is by emitting a gamma ray of energy 122 keV and going to an intermediate state first and then emitting a photon of energy 14 keV to reach the ground state. Both these emissions have been observed experimentally. Which type of decay a nucleus will undergo depends on which of the resulting daughter nucleus is more stable. Often, the daughter nucleus is also not stable and it undergoes further decay. A chain of decays may take place until the final daughter nucleus is stable. An example of such a series decay is that of ^{238}U , which undergoes a series of alpha and beta decays, a total of 14 times, to finally reach a stable daughter nucleus of ^{206}Pb .



Use your brain power

Why don't heavy nuclei decay by emitting a single proton or a single neutron?

15.10. Law of Radioactive Decay:

Materials which undergo alpha, beta or gamma decays are called radioactive materials. The nature of radioactivity is such

that if we have one atom of the radioactive material, we can never predict how long it will take to decay. If we have N_0 number of radioactive atoms (parent atoms or nuclei) of a particular kind say uranium, at time $t = 0$, all we can say is that their number will decrease with time as some nuclei (we cannot say which ones) will decay. Let us assume that at time t , number of parent nuclei which are left is $N(t)$. How many of these will decay in the interval between t and $t + dt$? We can guess that the larger the value of $N(t)$, larger will be the number of decays dN in time dt . Thus, we can say that dN will be proportional to $N(t)$. Also, we can guess that the larger the interval dt , larger will be the number of particles decaying in that interval. Thus, we can write,

$$dN \propto -N(t) dt,$$

$$\text{or, } dN = -\lambda N(t) dt \quad \text{--- (15.24)}$$

where, λ is a constant of proportionality called the **decay constant**. The negative sign in Eq.(15.24) indicates that the change in the number of parent nuclei dN , is negative, i.e., $N(t)$ is decreasing with time. We can integrate this equation as

$$\int_{N_0}^{N(t)} \frac{dN}{N(t)} = -\lambda \int_0^t dt,$$

Here, N_0 is the number of parent atoms at time $t = 0$. Integration gives,

$$\ln \frac{N(t)}{N_0} = -\lambda t,$$

$$\text{or, } N(t) = N_0 e^{-\lambda t} \quad \text{---(15.25)}$$

This is the **decay law** of radioactivity. The rate of decay, i.e., the number of decays per unit time $-\frac{dN(t)}{dt}$, also called the **activity** $A(t)$,

can be written using Eq.(15.24) and (15.25) as,

$$A(t) = -\frac{dN}{dt} = \lambda N(t) = \lambda N_0 e^{-\lambda t} \quad \text{--- (15.26)}$$

At $t = 0$, the activity is given by $A_0 = \lambda N_0$.

Using this, Eq.(15.26) can be written as

$$A(t) = A_0 e^{-\lambda t} \quad \text{--- (15.27)}$$

Activity is measured in units of becquerel (Bq) in SI units. One becquerel is equal to one decay per second. Another unit to measure activity is curie (Ci). One curie is 3.7×10^{10} decays per second. Thus, $1 \text{ Ci} = 3.7 \times 10^{10} \text{ Bq}$.

15.10.1. Half-life of Radioactive Material:

The time taken for the number of parent radioactive nuclei of a particular species to reduce to half its value is called the half-life $T_{1/2}$, of the species. This can be obtained from Eq. (15.25)

$$\frac{N_0}{2} = N_0 e^{-\lambda T_{1/2}}, \text{ giving}$$

$$e^{\lambda T_{1/2}} = 2,$$

$$\text{or } T_{1/2} = \frac{\ln 2}{\lambda} = 0.693 / \lambda \quad \text{--- (15.28)}$$

The interesting thing about half-life is that even though the number goes down from N_0 to $\frac{N_0}{2}$ in time $T_{1/2}$, after another time interval $T_{1/2}$, the number of parent nuclei will not go to zero. It will go to half of the value at $t = T_{1/2}$, i.e., to $\frac{N_0}{4}$. Thus, in a time interval equal to half-life, the number of parent nuclei reduces by a factor of $\frac{1}{2}$.

15.10.2 Average Life of a Radioactive Species:

We have seen that different nuclei of a given radioactive species decay at different times, i.e., they have different life times. We can calculate the average life time of a nucleus of the material using Eq.(15.25) as described below.

The number of nuclei decaying between time t and $t + dt$ is given by $\lambda N_0 e^{-\lambda t} dt$. The life time of these nuclei is t . Thus, the average lifetime τ of a nucleus is

$$\tau = \frac{1}{N_0} \int_0^{\infty} t \lambda N_0 e^{-\lambda t} dt = \lambda \int_0^{\infty} t e^{-\lambda t} dt,$$

Integrating the above we get

$$\tau = 1 / \lambda \quad \text{--- (15.29)}$$

The relation between the average life and half-life can be obtained using Eq.(15.28) as

$$T_{1/2} = \tau \ln 2 = 0.693 \tau \quad \text{--- (15.30)}$$

Example 15.9: The half-life of a nuclear species ${}^N\text{X}$ is 3.2 days. Calculate its (i) decay constant, (ii) average life and (iii) the activity of its sample of mass 1.5 mg.

Solution: The half-life ($T_{1/2}$) is related to the decay constant (λ) by

$$T_{1/2} = 0.693 / \lambda \text{ giving,}$$

$$\lambda = 0.693 / T_{1/2}$$

$$= 0.693/3.2$$

$$= 0.2166 \text{ per day}$$

$$= 0.2166 / (24 \times 3600) \text{ s}^{-1}$$

$$= 2.5 \times 10^{-6} \text{ s}^{-1}.$$

Average life is related to decay constant by $\tau = 1 / \lambda = 1/0.2166 \text{ per day} = 4.617 \text{ days}$
The activity is given by $A = \lambda N(t)$, where $N(t)$ is the number of nuclei in the given sample. This is given by

$$N(t) = 6.02 \times 10^{23} \times 1.5 \times 10^{-3} / Y = 9.03 \times 10^{20} / Y$$

Here, Y is the atomic mass of nuclear species X in g per mol.

$$\therefore A = 9.03 \times 10^{20} \times 2.5 \times 10^{-6} / Y$$

$$= 2.257 \times 10^{15} / Y$$

$$= 2.257 \times 10^{15} / (Y \times 3.7 \times 10^{10}) \text{ Ci}$$

$$= 6.08 \times 10^4 / Y \text{ Ci.}$$

Example 15.10: The activity of a radioactive sample decreased from 350 s^{-1} to 175 s^{-1} in one hour. Determine the half-life of the species.

Solution: The time dependence of activity is given by $A(t) = A_0 e^{-\lambda t}$, where, $A(t)$ and A_0 are the activities at time t and 0 respectively.

$$175 = 350 e^{-\lambda \cdot 3600},$$

$$\text{or, } 3600 \lambda = \ln (350/175) = \ln 2 = 0.6931$$

$$\lambda = 0.6931/3600 = 1.925 \times 10^{-4} \text{ s}^{-1}.$$

The half-life is given by $T_{1/2} = 0.693 / \lambda$.

$$\therefore T_{1/2} = \frac{0.693}{1.925 \times 10^{-4}} = 3.6 \times 10^3 \text{ s}$$

Example 15.11: In an alpha decay, the daughter nucleus produced is itself unstable and undergoes further decay. If the number of parent and daughter nuclei at time t are N_p and N_d respectively and their decay

constants are λ_p and λ_d respectively. What condition needs to be satisfied in order for N_d to remain constant?

Solution: The number of parent nuclei decaying between time 0 and dt , for small values of dt is given by $N_p \lambda_p dt$. This is the number of daughter nuclei produced in time dt . The number of daughter nuclei decaying in the same interval is $N_d \lambda_d dt$. For the number of daughter nuclei to remain constant, these two quantities, i.e., the number of daughter nuclei produced in time dt and the number decaying in time dt have to be equal. Thus, the required condition is given by

$$N_p \lambda_p dt = N_d \lambda_d dt,$$

$$\text{or, } N_p \lambda_p = N_d \lambda_d$$

15.11. Nuclear Energy:

You are familiar with the naturally occurring, conventional sources of energy. These include the fossil fuels, i.e., coal, petroleum, natural gas, and fire wood. The energy generation from these fuels is through chemical reactions. It takes millions of years for these fuels to form. Naturally, the supply of these conventional sources is limited and with indiscriminate use, they are bound to get over in a couple of hundred years from now. Therefore, we have to use alternative sources of energy. The ones already in use are hydroelectric power, solar energy, wind energy and nuclear energy, nuclear energy being the largest source among these.

Nuclear energy is the energy released when nuclei undergo a **nuclear reaction**, i.e., when one nucleus or a pair of nuclei, due to their interaction, undergo a change in their structure resulting in new nuclei and generating energy in the process. While the energy generated in chemical reactions is of the order of few eV per reaction, the amount of energy released in a nuclear reaction is of the order of a few MeV. Thus, for the same weight

of fuel, the nuclear energy released is about a million times that released through chemical reactions. However, nuclear energy generation is a very complex and expensive process and it can also be extremely harmful. Let us learn more about it.

We have seen in section 15.8 that the mass of a nucleus is smaller than the sum of masses of its constituents. The difference in these two masses is the binding energy of the nucleus. It would be the energy released if the nucleus is formed by bringing together its constituents from infinity. This energy is large (in MeV), and this process can be a good source of energy. In practice, we never form nuclei starting from individual nucleons. However, we can obtain nuclear energy by two other processes (i) nuclear fission in which a heavy nucleus is broken into two nuclei of smaller masses and (ii) nuclear fusion in which two light nuclei undergo nuclear reaction and fuse together to form a heavier nucleus. Both fission and fusion are nuclear reactions. Let us understand how nuclear energy is released in the two processes.

15.11.1. Nuclear Fission:

We have seen in Fig.15.6 that the binding energy per nucleon (E_B/A) depends on the mass number of the nuclei. This quantity is a measure of the stability of the nucleus. As seen from the figure, the middle weight nuclei (mass number ranging from 50 to 80) have highest binding energy per nucleon and are most stable, while nuclei with higher and lower atomic masses have smaller values of E_B/A . The value of E_B/A goes on decreasing till $A \sim 238$ which is the mass number of the heaviest naturally occurring element which is uranium. Many of the heavy nuclei are unstable and decay into two smaller mass nuclei.

Let us consider a case when a heavy nucleus, say with $A \sim 230$, breaks into two nuclei having A between 50 and 150. The E_B/A of the product nuclei will be higher than that

of the parent nucleus. This means that the combined masses of the two product nuclei will be smaller than the mass of the parent nucleus. The difference in the mass of the parent nucleus and that of the product nuclei taken together will be released in the form of energy in the process. This process in which a heavy nucleus breaks into two lighter nuclei with the release of energy is called **nuclear fission** and is a source of nuclear energy.

One of the nuclei used in nuclear energy generation by fusion is ${}_{92}^{236}\text{U}$. This has a half-life of 2.3×10^7 years and an activity of 6.5×10^{-5} Ci/g. However, it being fissionable, most of its nuclei have already decayed and it is not found in nature. More than 99% of natural uranium is in the form of ${}_{92}^{238}\text{U}$ and less than 1% is in the form of ${}_{92}^{235}\text{U}$. ${}_{92}^{238}\text{U}$ also decays, but its half-life is about 10^3 times higher than that of ${}_{92}^{236}\text{U}$ and is therefore not very useful for energy generation. The species needed for nuclear energy generation, i.e., ${}_{92}^{236}\text{U}$ can be obtained from the naturally occurring ${}_{92}^{235}\text{U}$ by bombarding it with slow neutrons. ${}_{92}^{235}\text{U}$ absorbs a neutron and yields ${}_{92}^{236}\text{U}$. This reaction can be written as ${}_{92}^{235}\text{U} + \text{n} \rightarrow {}_{92}^{236}\text{U}$. ${}_{92}^{236}\text{U}$ can undergo fission in several ways producing different pairs of daughter nuclei and generating different amounts of energy in the process. Some of its decays are

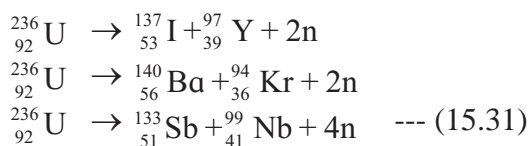

Some of the daughter nuclei produced are not stable and they further decay to produce more stable nuclei. The energy produced in the fission is in the form of kinetic energy of the products, i.e., in the form of heat which can be collected and converted to other forms of energy as needed.

Uranium Nuclear Reactor:

A nuclear reactor is an apparatus or a device in which nuclear fission is carried out

in a controlled manner to produce energy in the form heat which is then converted to electricity. In a uranium reactor, ${}_{92}^{235}\text{U}$ is used as the fuel. It is bombarded by slow neutrons to produce ${}_{92}^{236}\text{U}$ which undergoes fission.

Example 15.12: Calculate the energy released in the reaction

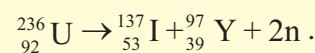

The masses of ${}_{92}^{236}\text{U}$, ${}_{53}^{137}\text{I}$ and ${}_{39}^{97}\text{Y}$ are 236.04557, 136.91787 and 96.91827 respectively.

Solution: Energy released is given by

$$\begin{aligned} Q &= [m_{\text{U}} - m_{\text{I}} - m_{\text{Y}} - 2m_{\text{n}}]c^2 \\ &= [236.04557 - 136.91787 - \\ &\quad 96.91827 - 2 \times 1.00865] c^2 \\ &= 0.19011 \times 931.5 \text{ MeV} \\ &= 177.0875 \text{ MeV} \end{aligned}$$

Chain Reaction:

Neutrons are produced in the fission reaction shown in Eq. (15.31). Some reactions produce 2 neutrons while others produce 3 or 4 neutrons. The average number of neutrons per reaction can be shown to be 2.7. These neutrons are in turn absorbed by other ${}_{92}^{235}\text{U}$ nuclei to produce ${}_{92}^{236}\text{U}$ which undergo fission and produce further 2.7 neutrons per fission. This can have a cascading effect and the number of neutrons produced and therefore the number of ${}_{92}^{236}\text{U}$ nuclei produced can increase quickly. This is called a **chain reaction**. Such a reaction will lead to a fast increase in the number of fissions and thereby in a rapid increase in the amount of energy produced. This will lead to an explosion. In a nuclear reactor, methods are employed to stop a chain reaction from occurring and fission and energy generation is allowed to occur in a controlled fashion. The energy generated, which is in the form of heat, is carried away and converted to electricity by using turbines etc.

More than 15 countries have nuclear reactors and use nuclear power. India is one of them. There are 22 nuclear reactors in India,

the largest one being at Kudankulam, Tamil Nadu. Maximum nuclear power is generated by the USA.

15.11.2. Nuclear Fusion:

We have seen that light nuclei ($A < 40$) have lower E_B/A as compared to heavier ones. If any two of the lighter nuclei come sufficiently close, within about one fm of each other, then they can undergo nuclear reaction and form a heavier nucleus. The heavier nucleus will have higher E_B/A than the reactants. The mass of the product nucleus will therefore be lower than the total mass of the reactants, and energy of the order of MeV will be released in the process. This process wherein two nuclei fuse together to form a heavier nucleus accompanied by a release of nuclear energy is called **nuclear fusion**.

For a nuclear reaction to take place, it is necessary for two nuclei to come to within about 1 fm of each other so that they can experience the nuclear forces. It is very difficult for two atoms to come that close to each other due to the electrostatic repulsion between the electrons of the two atoms. This problem can be solved by stripping the atoms of their electrons and producing bare nuclei. It is possible to do so by giving the electrons energies larger than the ionization potentials of the atoms by heating a gas of atoms. But even after this, the two bare nuclei find it very difficult to go near each other due to the repulsive force between their positive charges. For nuclear fusion to occur, we have to heat the gas to very high temperature thereby providing the nuclei with very high kinetic energies. These high energies can help them to overcome the electrostatic repulsion and come close to one another. As the positive charge of a nucleus goes on increasing with increase in its atomic number, the kinetic energies of the nuclei, i.e., the temperature of the gas necessary for nuclear fusion to occur goes on increasing with increase in Z .

Nuclear fusion is taking place all the time in the universe. It mostly takes place at the centres of stars where the temperatures are high enough for nuclear reactions to take place. There, light nuclei fuse into heavier nuclei generating energy in the process. Nuclear fusion is in fact the source of energy for stars. Most of the elements heavier than boron till iron, that we see around us today have been produced through nuclear fusion inside stars.



Do you know?

Light elements, i.e., deuterium, helium, lithium, beryllium and boron, have not been created inside stars, but are believed to have been created within the first 200 second in the life of the universe, i.e., within 200 seconds of the big bang which marked the beginning of the universe. The temperature at that time was very high and some nuclear reactions could take place. After about 200 s, the temperature decreased and nuclear reactions were no longer possible.

The temperature at the centre of the Sun is about 10^7 K. The nuclear reactions taking place at the centre of the Sun are the fusion of four hydrogen nuclei, i.e., protons to form a helium nucleus. Of course, because of the electrostatic repulsion and the values of densities at the centre of the Sun, it is extremely unlikely that four protons will come sufficiently close to one another at a given time so that they can combine to form helium. Instead, the fusion proceeds in several steps. The effective reaction can be written as



These reactions have been going on inside the Sun since past 4.5 billion years and are expected to continue for similar time period in the future. At the centres of other stars where temperatures are higher, nuclei heavier than hydrogen can fuse generating energy.

**Do you know?**

The fusion inside stars can only take place between nuclei having mass number smaller than that of iron, i.e., 56. The reason for this is that iron has the highest E_B/A value among all elements as seen from Fig.15.6. If an iron nucleus fuses into another nucleus, the atomic number of the resulting nucleus will be higher than that of iron and hence it will have smaller E_B/A . The mass of the resultant nucleus will hence be larger than the sum of masses of the reactants and energy will have to be supplied to the reactants for the reaction to take place. The elements heavier than iron which are present in the universe are produced via other type of nuclear reaction which take place during stellar explosions.

Example 15.13: Calculate the energy released in the fusion reaction taking place inside the Sun, $4p \rightarrow \alpha + 2e^+ + \text{neutrinos}$, neglecting the energy given to the neutrinos. Mass of alpha particle being 4.001506 u.

Solution: The energy released in the process, ignoring the energy taken by the neutrinos is given by

$$Q = [4 \times m_p - m_\alpha - 2 \times m_e] c^2$$

$$Q = [4 \times 1.00728 - 4.001506 - 2 \times 0.00055] c^2$$

$$= 0.026514 \times 931.5 = 24.698 \text{ MeV}$$

The discussion on nuclear energy will not be complete without mentioning its harmful effects. If an uncontrolled chain reaction sets up in a nuclear fuel, an extremely large amount of energy can be generated in a very short time. This fact has been used to produce what are called atom bombs or nuclear devices. Either fission alone or both fission and fusion are used in these bombs. The first such devices were made towards the end of the second world war by America. By now, several countries including India have successfully made and

tested such nuclear devices. America remains the only country to have actually used two atom bombs which completely destroyed the cities of Hiroshima and Nagasaki in Japan in early August 1945.

**Do you know?**

We have seen that the activity of radioactive material decreases exponentially with time. Other examples of exponential decay are

- Amplitude of a simple pendulum decays exponentially as $A = A_0 e^{-bt}$, where b is damping factor.
- Cooling of an object in an open surrounding is exponential. Temperature $\theta = \theta_0 e^{-kt}$ where k depends upon the object and the surrounding.
- Discharging of a capacitor through a pure resistor is exponential. Charge Q on the capacitor at a given instant is $Q = Q_0 e^{-t/RC}$ where RC is called time constant.
- Charging of a capacitor is also exponential but, it is called exponential growth.

**Internet my friend**

1. <https://www.siyavula.com/read/science/grade-10/the-atom/04-the-atom-02>
2. https://en.wikipedia.org/wiki/Bohr_model
3. <http://hyperphysics.phy-astr.gsu.edu/hbase/quantum/atomstructcon.html>
4. https://en.wikipedia.org/wiki/Atomic_nucleus
5. https://en.wikipedia.org/wiki/Radioactive_decay

**Exercises**

In solving problems, use $m_e = 0.00055 \text{ u} = 0.511 \text{ MeV}/c^2$, $m_p = 1.00728 \text{ u} = 938.272 \text{ MeV}/c^2$, $m_n = 1.00866 \text{ u} = 939.565 \text{ MeV}/c^2$ and $m_H = 1.007825 \text{ u}$.

1. Choose the correct option.

- In which of the following systems will the radius of the first orbit of the electron be smallest?
(A) hydrogen (B) singly ionized helium
(C) deuteron (D) tritium
- The radius of the 4th orbit of the electron will be smaller than its 8th orbit by a factor of
(A) 2 (B) 4
(C) 8 (D) 16
- In the spectrum of hydrogen atom which transition will yield longest wavelength?
(A) $n = 2$ to $n = 1$ (B) $n = 5$ to $n = 4$
(C) $n = 7$ to $n = 6$ (D) $n = 8$ to $n = 7$
- Which of the following properties of a nucleus does not depend on its mass number?
(A) radius (B) mass
(C) volume (D) density
- If the number of nuclei in a radioactive sample at a given time is N , what will be the number at the end of two half-lives?
(A) $N/2$ (B) $N/4$
(C) $3N/4$ (D) $N/8$

2. Answer in brief.

- State the postulates of Bohr's atomic model.
 - State the difficulties faced by Rutherford's atomic model.
 - What are alpha, beta and gamma decays?
 - Define excitation energy, binding energy and ionization energy of an electron in an atom.
 - Show that the frequency of the first line in Lyman series is equal to the difference between the limiting frequencies of Lyman and Balmer series.
- State the postulates of Bohr's atomic model and derive the expression for the energy of an electron in the atom.
 - Starting from the formula for energy of an electron in the n^{th} orbit of hydrogen atom, derive the formula for the wavelengths of Lyman and Balmer series spectral lines and determine the shortest wavelengths of lines in both these series.
 - Determine the maximum angular speed of an electron moving in a stable orbit around the nucleus of hydrogen atom.
 - Determine the series limit of Balmer, Paschen and Pfund series, given the limit for Lyman series is 912 \AA .
[Ans: 3646 \AA , 8204 \AA and 14585 \AA]
 - Describe alpha, beta and gamma decays and write down the formulae for the energies generated in each of these decays.
 - Explain what are nuclear fission and fusion giving an example of each. Write down the formulae for energy generated in each of these processes.
 - Describe the principles of a nuclear reactor. What is the difference between a nuclear reactor and a nuclear bomb?
 - Calculate the binding energy of an alpha particle given its mass to be 4.00151 u .
[Ans: 28.535 MeV]
 - An electron in hydrogen atom stays in its second orbit for 10^{-8} s . How many revolutions will it make around the nucleus in that time?
[Ans: 8.23×10^6]
 - Determine the binding energy per nucleon of the americium isotope ${}_{95}^{244}\text{Am}$, given the mass of ${}_{95}^{244}\text{Am}$ to be 244.06428 u .
[Ans: 7.5836 MeV]
 - Calculate the energy released in the nuclear reaction ${}^7_3\text{Li} + \text{p} \rightarrow 2\alpha$ given mass of ${}^7_3\text{Li}$ atom and of helium atom to be 7.016 u and 4.0026 u respectively.
[Ans: 17.499 MeV]

14. Complete the following equations describing nuclear decays.
 (a) ${}^{226}_{86}\text{Ra} \rightarrow \alpha +$ (b) ${}^{19}_8\text{O} \rightarrow e^- +$
 (c) ${}^{228}_{90}\text{Th} \rightarrow \alpha +$ (d) ${}^{12}_7\text{N} \rightarrow {}^{12}_6\text{C} +$
15. Calculate the energy released in the following reactions, given the masses to be ${}^{223}_{88}\text{Ra}$: 223.0185 u, ${}^{209}_{82}\text{Pb}$: 208.9811, ${}^{14}_6\text{C}$: 14.00324, ${}^{236}_{92}\text{U}$: 236.0456, ${}^{140}_{56}\text{Ba}$: 139.9106, ${}^{94}_{36}\text{Kr}$: 93.9341, ${}^{11}_5\text{B}$: 11.01143, ${}^{11}_5\text{B}$: 11.0093. Ignore neutrino energy.
 (a) ${}^{223}_{88}\text{Ra} \rightarrow {}^{209}_{82}\text{Pb} + {}^{14}_6\text{C}$
 (b) ${}^{236}_{92}\text{U} \rightarrow {}^{140}_{56}\text{Ba} + {}^{94}_{36}\text{Kr} + 2n$
 (c) ${}^{11}_5\text{C} \rightarrow {}^{11}_5\text{B} + e^+ + \text{neutrino}$
 [Ans: a) 32.096 MeV, b) 172.485 MeV, c) 1.485 MeV]
16. Sample of carbon obtained from any living organism has a decay rate of 15.3 decays per gram per minute. A sample of carbon obtained from very old charcoal shows a disintegration rate of 12.3 disintegrations per gram per minute. Determine the age of the old sample given the decay constant of carbon to be 3.839×10^{-12} per second.
 [Ans: 1803 yrs]
17. The half-life of ${}^{90}_{38}\text{Sr}$ is 28 years. Determine the disintegration rate of its 5 mg sample.
 [Ans: $2.626 \times 10^{10} \text{ s}^{-1}$]
18. What is the amount of ${}^{60}_{27}\text{Co}$ necessary to provide a radioactive source of strength 10.0 mCi, its half-life being 5.3 years?
 [Ans: $8.88 \times 10^{-6} \text{ g}$]
19. Disintegration rate of a sample is 10^{10} per hour at 20 hrs from the start. It reduces to 6.3×10^9 per hour after 30 hours. Calculate its half life and the initial number of radioactive atoms in the sample.
 [Ans: 15 hrs, 5.45×10^{11}]
20. The isotope ${}^{57}\text{Co}$ decays by electron capture to ${}^{57}\text{Fe}$ with a half-life of 272 d. The ${}^{57}\text{Fe}$ nucleus is produced in an excited state, and it almost instantaneously emits gamma rays. (a) Find the mean lifetime and decay constant for ${}^{57}\text{Co}$. (b) If the activity of a radiation source ${}^{57}\text{Co}$ is 2.0 μCi now, how many ${}^{57}\text{Co}$ nuclei does the source contain? (c) What will be the activity after one year?
 [Ans: 3.39×10^7 , $2.95 \times 10^{-8} \text{ s}^{-1}$, 2.51×10^{12} nuclei, 0.789 μCi]
21. A source contains two species of phosphorous nuclei, ${}^{32}_{15}\text{P}$ ($T_{1/2} = 14.3 \text{ d}$) and ${}^{33}_{15}\text{P}$ ($T_{1/2} = 25.3 \text{ d}$). At time $t = 0$, 90% of the decays are from ${}^{32}_{15}\text{P}$. How much time has to elapse for only 15% of the decays to be from ${}^{32}_{15}\text{P}$?
 [Ans: 186.6 d]
22. Before the year 1900 the activity per unit mass of atmospheric carbon due to the presence of ${}^{14}\text{C}$ averaged about 0.255 Bq per gram of carbon. (a) What fraction of carbon atoms were ${}^{14}\text{C}$? (b) An archaeological specimen containing 500 mg of carbon, shows 174 decays in one hour. What is the age of the specimen, assuming that its activity per unit mass of carbon when the specimen died was equal to the average value of the air? Half-life of ${}^{14}\text{C}$ is 5730 years?
 [Ans: Four atoms in every 3×10^{12} carbon atoms were ${}^{14}\text{C}$, 8020 years]
23. How much mass of ${}^{235}\text{U}$ is required to undergo fission each day to provide 3000 MW of thermal power? Average energy per fission is 202.79 MeV
 [Ans: 3.1 kg]
24. In a periodic table the average atomic mass of magnesium is given as 24.312 u. The average value is based on their relative natural abundance on earth. The three isotopes and their masses are ${}^{24}_{12}\text{Mg}$ (23.98504 u), ${}^{25}_{12}\text{Mg}$ (24.98584 u) and ${}^{26}_{12}\text{Mg}$ (25.98259 u). The natural abundance of ${}^{24}_{12}\text{Mg}$ is 78.99% by mass. Calculate the abundances of other two isotopes.
 [Ans: 9.3% and 11.7%]

16. Semiconductor Devices



Can you recall?

1. What is a p-n junction diode?
2. What is breakdown voltage and knee voltage?
3. What is a forward and reverse biased diode?

16.1 Introduction

In XIth Std. we have studied a p-n junction diode. When the diode is forward biased, it behaves as a closed switch and current flows in the diode circuit. When the diode is reverse biased, it behaves as an open switch and no current flows in the diode circuit. This switching action of a diode allows it to be used as a rectifier.

Generation of AC at a power station is more cost effective than producing DC power. The transmission of AC power is also more economic than transmitting DC power. This AC voltage varies sinusoidally. In India, it is 230 V and has a frequency of 50 Hz. There are many electronic gadgets such as a TV, or a mobile charger which require a DC supply. Therefore, it is necessary to convert AC voltage into a DC voltage. The AC mains voltage is rectified by using junction diodes to obtain a DC voltage. In this chapter, we will study the use of diode as a rectifier and also different types of rectifiers. We will also study filters which remove the AC component from the rectified voltage and voltage regulators which provide the required DC voltage.

Working of a simple rectifier circuit is shown in Fig. 16.1. The AC mains supply is connected to the primary of a transformer and its secondary is connected to a rectifier circuit. The AC voltage shown as a sinusoidal wave from the secondary of the transformer is converted into a DC voltage by a diode rectifier. This is shown next as a pulsating wave (b). The output of the rectifier contains some AC component. This AC component in the DC output of a rectifier is called *ripple* and is shown at the output of the rectifier. It is removed by using a *filter circuit*. The output of the filter circuit is almost a pure DC. (It can still contain some ripple). The *voltage regulator circuit* shown after the filter restricts the output voltage to the desired value. The output voltage at this stage is a across pure DC (d).

16.2 p-n Junction Diode as a Rectifier

An AC voltage varies sinusoidally, i.e. its value and direction changes in one cycle. A rectifier converts this bidirectional voltage or current into a unidirectional voltage or current. *The conversion of AC voltage into a DC voltage is called rectification.* An electronic circuit which rectifies AC voltage is called rectifier. There are two types of rectifier circuits, 1) half wave rectifier and 2) full wave rectifier.

16.2.1 Half Wave Rectifier

A simple half wave rectifier circuit using only one diode is shown in Fig. 16.2.

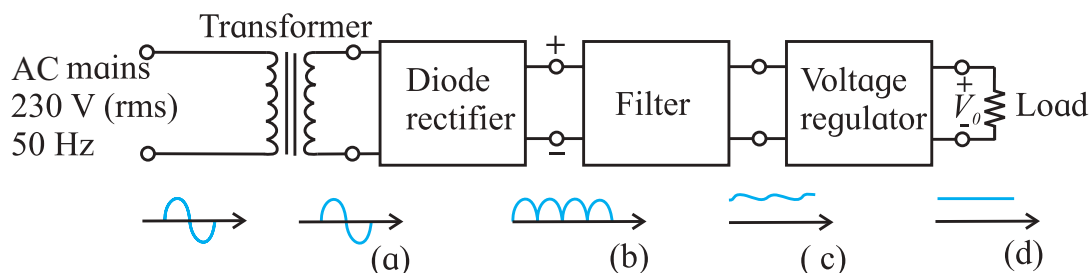

16.1: Block diagram simple rectifier circuit with respective output wave form. Describe the wave forms.

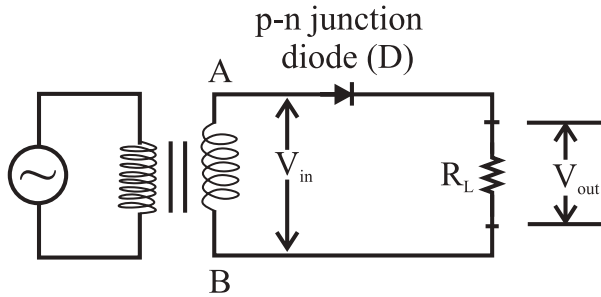

Fig. 16.2: Circuit diagram of a half wave rectifier.

The secondary coil AB of a transformer is connected in series with a diode D and the load resistance R_L . The use of transformer has two advantages. First, it allows us to step up or step down the AC input voltage as per the requirement of the circuit, and second it isolates the rectifier circuit from the mains supply to reduce the risk of electric shock. The AC voltage across the secondary coil AB changes its polarities after every half cycle. When the positive half cycle begins, the voltage at the point A is at higher potential with respect to that at the point B, therefore, the diode (D) is forward biased. It conducts (works as a closed switch) and current flows through the circuit. When the negative half cycle begins, the potential at the point A is lower with respect to that at the point B and the diode is reverse biased, therefore, it does not conduct (works as an open switch). No current passes through the circuit. Hence, the diode conducts only in the positive half cycles of the AC input. It blocks the current during the negative half cycles. The waveform for input and output voltages are shown in Fig. 16.3. In this way, current always flows through the load R_L in the same direction for alternate positive half cycles.

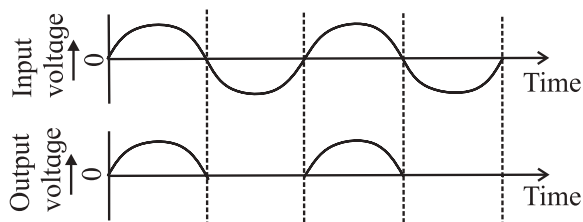

Fig. 16.3: Waveform of input and output signals for half wave rectifier.

Hence a DC output voltage obtained across R_L is in the form of alternate pulses.

16.2.2 Full Wave Rectifier:

As discussed in the previous section, the output of a half wave rectifier is available only in alternate positive half cycles of the AC input. All negative half cycles are lost and the efficiency of a half wave rectifier is very poor. Therefore, a rectifier circuit using two diodes is more useful.

In a full wave rectifier, current flows through the load in the same direction during both the half cycles of input AC voltage. This is because, the full wave rectifier circuit consists of two diodes conducting alternately. Figure 16.4 shows typical circuit of a full wave rectifier. The circuit consists of a centre tapped transformer and diodes D_1 and D_2 .

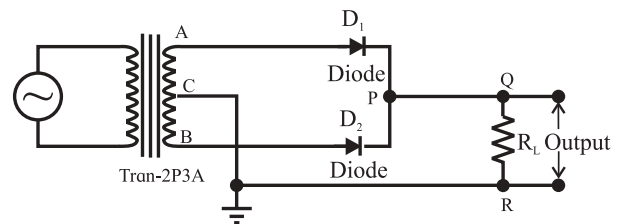

Fig. 16.4: Circuit diagram for full wave rectifier.

The diodes D_1 and D_2 are connected such that D_1 conducts in the positive half cycle and D_2 conducts in the negative half cycle of the input voltage. During the positive half cycle of the input voltage, the point A is at a higher potential than that of the point B and the diode D_1 conducts. The current through the load resistance R_L follows the path APQRC as shown in Fig. 16.4. During the negative half cycle of the input voltage, point B is at higher potential than point A and the diode D_2 conducts. The current through the load resistance R_L follows the path BPQRC. Thus, the current flowing through the load resistance is in the same direction during both the cycles.

The input and output waveforms of a full wave rectifier are shown in Fig. 16.5. First waveform is input AC. The second wave form shows the output when the diode D_1 conducts and the third waveform shows the output when diode D_2 conducts. The fourth waveform

shows the total output waveform of the full wave rectifier.

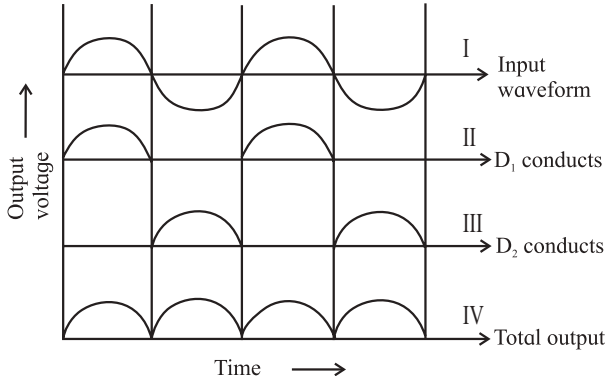

Fig 16.5: Waveforms of input and output signals for a full wave rectifier.



Remember this

A full wave rectifier utilises both half cycles of AC input voltage to produce the DC output



Do you know?

The maximum efficiency of a full wave rectifier is 81.2% and the maximum efficiency of a half wave rectifier is 40.6%. It is observed that the maximum efficiency of a full wave rectifier is twice that of half wave rectifier.

Advantages of a full wave rectifier

- 1) Rectification takes place in both the cycles of the AC input.
- 2) Efficiency of a full wave rectifier is higher than that of a half wave rectifier.
- 3) The ripple in a full wave rectifier is less than that in a half wave rectifier.

Example 16.1 : If the frequency of the input voltage 50 Hz is applied to a (a) half wave rectifier and (b) full wave rectifier, what is the output frequency in both cases?

Solution:

- (a) The output frequency is 50 Hz because for one AC input pulsating we get one cycle of DC.
- (b) The output frequency is 100Hz because for one input ac cycle we get two cycles of pulsating DC.

16.2.3 Ripple Factor:

The output of a rectifier consists of a small fraction of an AC component along with DC called the ripple. This ripple is undesirable and is responsible for the fluctuations in the rectifier output. Figure 16.6 (a) shows the ripple in the output of a rectifier.

The effectiveness of a rectifier depends upon the magnitude of the ripple component in its output. A smaller ripple means that the rectifier is more effective.

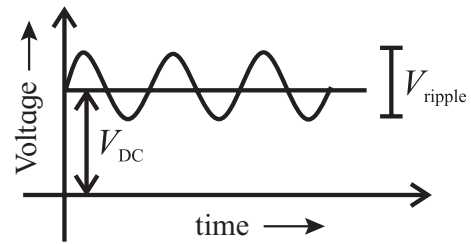

Fig. 16.6 (a): Ripple in the output of a DC output.

The ratio of root mean square (rms) value of the AC component to the value of the DC component in the rectifier output is known as the ripple factor, i.e.,

$$\text{Ripple factor} = \frac{\text{r.m.s. value of AC component}}{\text{value of DC component}}$$

16.2.4 Filter circuits:

The output of a rectifier is in the form of pulses as shown in the fourth waveform in Fig 16.5. The output is unidirectional but the output does not have a steady value. It keeps fluctuating due to the ripple component present in it. A filter circuit is used to remove the ripple from the output of a rectifier.

A filter circuit is a circuit which removes the AC component or the ripple from a rectifier output and allows only the DC component.

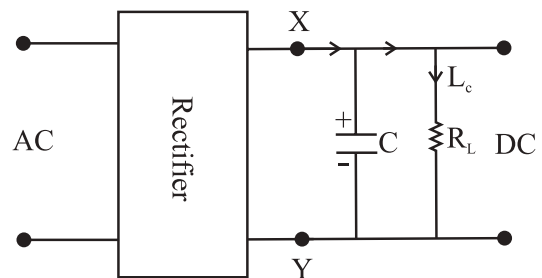

Fig. 16.6 (b): Filter circuit with capacitor.

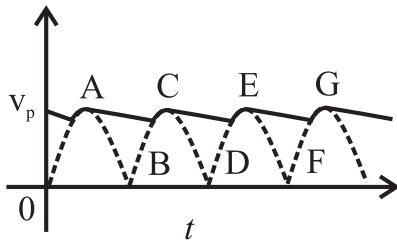

Fig. 16.6 (c): Output wave form after filtration.

A capacitor filter:

As shown in Fig. 16.6 (b), the pulsating DC voltage of a rectifier output is applied across the capacitor. As the voltage across the capacitor rises, capacitor gets charged to point A and supplies current to the load resistance. At the end of quarter cycle, the capacitor gets charged to the peak voltage shown as V_p in Fig. 16.7 (c) of the rectified output voltage. Now, the rectifier voltage begins to decrease, so that the capacitor starts discharging through the load resistance and the voltage across it begins to drop. Voltage across the load decreases only slightly, up to the point B, because the next voltage peak recharges the capacitor immediately. This process is repeated again and again and the output voltage waveform takes the form shown in Fig 16.6 (c). This output is unregulated DC wave form. Voltage regulator circuits are used to obtain regulated DC supply. The capacitor filter circuit is widely used because of its low cost, small size and light weight. This type of filter is preferred for small load currents. It is commonly used in battery eliminators.

When a power supply is connected to a load, it is noticed that there is a drop in the output voltage. A power supply whose output changes when a load is connected across it is called *unregulated power supply*. When the output of a power supply remains steady even after connecting a load across it, it is called a *regulated power supply*. There are many ways in which a power supply can be regulated. A commonly used voltage regulator circuit uses a Zener diode. We will now discuss a Zener

diode first and then try to understand how it can be used as a voltage regulator.

16.3 Special Purpose Junction Diodes:

In this section we will study some of the common special purpose junction diodes such as,

1) Zener diode, 2) Photo diode, 3) Solar cell, 4) Light Emitting Diode (LED).

16.3.1 Zener Diode:

A Zener diode works on the principle of junction breakdown. The other diodes mentioned above make use of photosensitivity, a very important and useful property of semiconductors.

16.3 : Junction Break Down:

In XIth Std. we have studied that when reverse bias voltage of an ordinary junction diode is increased beyond a critical voltage, the reverse current increases sharply to a high value. This critical voltage is called *reverse breakdown voltage*. The diode is damaged at this stage. We will now discuss what happens when there is a junction breakdown.

Electrical break down of any material (metal, semiconductor or even insulator) can be due to 1) **Avalanche breakdown** or 2) **Zener breakdown**. We will discuss only the Zener breakdown in some details.

Zener Breakdown :

When the reverse voltage across a p-n junction diode is increased, the electric field across the junction increases. This results in a force of attraction on the negatively charged electrons at the junction. Covalent bonds which hold the semiconductor together are broken due to this force and electrons are removed from the bonds. These free electrons are then available for electrical conduction and result in a large current. When the applied voltage is increased, the electric field across the junction also increases and more and more electrons are removed from their covalent bonds. Thus, a net current is developed which increases rapidly with increase in the applied voltage.

Zener breakdown occurs in diodes which are heavily doped. The depletion layer is narrow in such diodes. Zener breakdown does not result in damage of a diode.

Zener Diode Characteristic:

A Zener diode is a p-n junction diode designed to work in the breakdown region. It is used as a voltage regulator or a voltage stabiliser. Figure 16.7 (a) shows the circuit symbol of a Zener diode. Its I-V characteristic is shown in Fig. 16.7 (b).

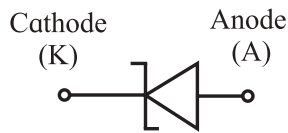

Fig 16.7 (a): circuit symbol of a Zener diode.

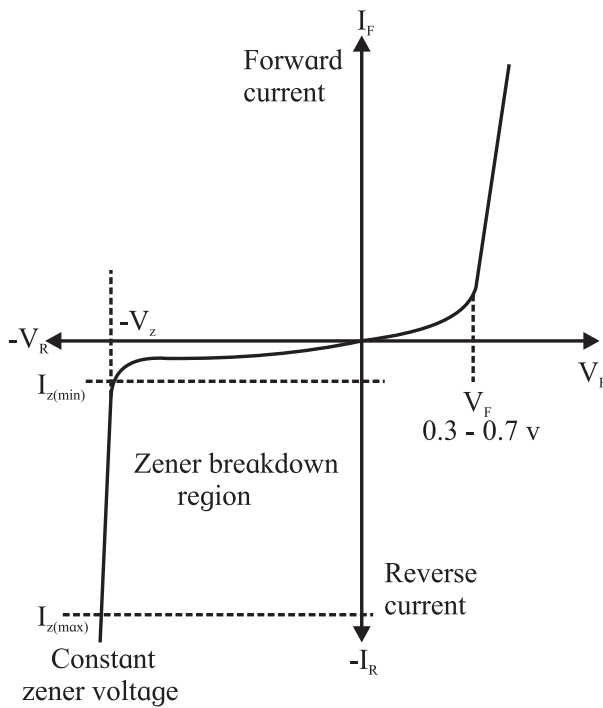

Fig 16.7: (b) I-V Characteristic curve for Zener Diode.

As can be seen from the characteristic, a Zener diode behaves like a normal diode when forward biased. When reverse biased, it shows a breakdown. This breakdown discussed previously occurs at a voltage called the Zener voltage V_Z . The current suddenly increases if the applied voltage is increased beyond the Zener voltage. It is interesting to note that the voltage remains constant at V_Z , for increasing current, once the Zener breakdown occurs.

This property of the Zener diode is used in a voltage regulator. The Zener voltage V_Z depends upon the amount of doping. For a heavily doped diode, the depletion layer is thin and the breakdown occurs at a lower reverse voltage. A lightly doped diode has higher breakdown voltage. The Zener diodes with breakdown voltage of less than 6 V, operate mainly at Zener breakdown region. Those with voltage greater than 6 V operate mainly in avalanche breakdown region (not discussed here) but both are called Zener diode.

Zener diode as a voltage regulator:

When a Zener diode is operated in the breakdown region, voltage across it remains almost constant even if the current through it changes by a large amount. A voltage regulator maintains a constant voltage across a load regardless of variations in the applied input voltage and variations in the load current. Figure 16.8 shows a typical circuit diagram of a voltage regulator using a Zener diode.

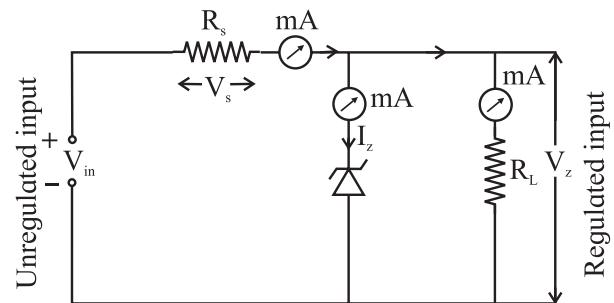

Fig. 16.8: Voltage regulator using a Zener diode.

A Zener diode of break down voltage V_Z is connected in reverse bias to an input voltage source V_i . The resistor, R_s connected in series with the Zener diode limits the current flow through the diode. The load resistance R_L is connected in parallel with the Zener diode, so that the voltage across R_L is always the same as the Zener voltage, ($V_R = V_Z$). We will try to understand how voltage is regulated using such circuit.

(a) If the input voltage increases, the current through R_s and the Zener diode also increases. This results in an increase in the

voltage across the resistance R_s , but the voltage across the Zener diode does not change. The series resistance R_s absorbs the output voltage fluctuations and maintains a constant voltage across the load resistance. This is because the Zener voltage remains constant even through the current through the Zener diode changes when it is in the breakdown region.

When the input voltage increases, the voltage across the series resistance R_s also increases. This causes an increase in the current through the Zener diode and the current through the load resistance remains constant. Hence the output voltage remains constant irrespective of the change in the input voltage.

(b) When the input voltage is constant but the load resistance R_L decreases, the load current increases. This extra current cannot come from the source because the drop across R_s will not change as the Zener is within its regulating range. The additional load current is due to a decrease in the Zener current I_Z .

(c) When there is no load in the circuit, the load current will be zero, ($I_L = 0$) and all the circuit current passes through the Zener diode. This results in maximum dissipation of power across the Zener diode. Similarly, a small value of the series resistor R_s results in a larger diode current when the load resistance R_L of a large value is connected across it. This will increase the power dissipation requirement of the diode. The value of the series resistance R_s is so selected that the maximum power rating of the Zener diode is not exceeded when there is no load or when the load is very high.

The voltage across the Zener diode remains constant at its break down voltage V_Z for all the values of Zener current I_Z as long as the current persists in the break down region. Hence, a regulated DC output voltage $V_o = V_Z$ is obtained across R_L whenever the input voltage remains within a minimum and maximum voltage.



Do you know?

The voltage stabilization is effective when there is a minimum Zener current. The Zener diode must be always operated within its breakdown region when there is a load connected in the circuit. Similarly, the supply voltage V_s must be greater than V_Z .

Working of a Zener Regulator:

Let $I_{Z(\min)}$, $I_{Z(\max)}$ be the minimum and maximum Zener currents respectively and V_Z be the Zener voltage.

Let V_s , be the voltage across R_s when the current is minimum, therefore, $V_s = (I_{Z(\min)} R_s)$. Eq. (16.1).

From the Fig. 16.8, we have,

$V_{in} = (V_s + V_Z)$. Thus, the lower value of the input voltage is,

$$V_{in(\text{low})} = (V_s + V_Z).$$

$$\therefore V_{in(\text{low})} = I_{Z(\min)} R_s + V_Z \quad \text{--- (16.2)}$$

Similarly, the voltage across R_s when the current is maximum will be, $V_s = (I_{Z(\max)} R_s)$ and

$$V_{in(\text{high})} = (V_s + V_Z) = (I_{Z(\max)} R_s) + V_Z$$

The maximum power rating (P_Z) of a Zener diode is given by, $P_Z = (I_{Z(\max)} V_Z)$.

While designing a Zener regulator, the value of series resistance is determined by considering the specification of the Zener diode.

Similarly, if the input voltage (V_i) decreases, the current through R_s and the Zener diode also decreases. Therefore, V_s , the voltage drop across R_s also decreases without any change in the voltage V_Z , across the Zener diode. Hence, any change in the input voltage does not change the voltage across the Zener diode. Thus, a Zener diode gives constant output voltage (V_o) across R_L . The limitation of this regulator is that the current through a Zener diode should never exceed the $I_{Z(\max)}$ value. If the current exceeds this value, the

Zener diode gets damaged due to heating. The $I_{Z(\max)}$ value is provided by manufacturer.



Remember this

Zener effect occurs only if the diode is heavily doped, because when the depletion layer is thin, breakdown occurs at low reverse voltage and the field strength will be approximately 3×10^7 V/m. It causes an increase in the flow of free carriers and increase in the reverse current.

Applications of Zener Diode: The Zener diode is used when a constant voltage is required. It has a number of applications such as: Voltage regulator, Fixed reference voltage provider in transistor biasing circuits, Peak clipper or limiter in a wave shaping circuit, Protector against meter damage from accidental fluctuations, etc.

Example 16. 2

A 5.0V stabilized power supply is required to be designed using a 12V DC power supply as input source. The maximum power rating P_Z of the Zener diode is 2.0 W. Using the Zener regulator circuit described in Fig. 16.8, calculate,

a) The maximum current flowing through the Zener diode. b) The minimum value of the series resistor, R_s . c) The load current I_L if a load resistor of $1k\Omega$ is connected across the Zener diode. d) The Zener current I_Z at full load.

Solution:

a) Maximum current $I_Z = \text{Power}/\text{Voltage} =$

$$P_Z / V_o = 2.0/5.0 = 0.4 \text{ A} = 400 \text{ mA.}$$

b) $R_s = (V_s - V_Z) / I_Z = (12.0 - 5.0) / 0.4$
 $= 17.5 \Omega.$

c) $I_L = V_Z / R_L = 5.0/1000 = 0.005 \text{ A} = 5.0 \text{ mA}$

d) $I_Z = I_s - I_L = (400 - 5) = 395 \text{ mA.}$



Can you tell?

1. How does a cell phone charger produce a voltage of 5.0 V from the line voltage of 230V?
2. Why is a resistance connected in series with a Zener diode when used in a circuit?



Do you know?

The voltage across a Zener diode does not remain strictly constant with the changes in the Zener current. This is due to R_Z , the Zener impedance, or the internal resistance of the Zener diode. R_Z acts like a small resistance in series with the Zener. Changes in I_Z cause small changes in V_Z .

16.3.2 Photo Diode :

A photodiode is a special type of a p-n junction diode which converts light energy into electrical energy. It generates current when exposed to light. It is also called as *photodetector* or a *photosensor*. It operates in reverse biased mode. Figure 16.9 (a) shows the

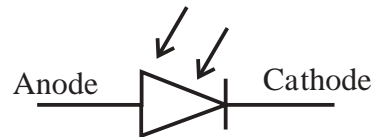

Fig. 16.9 (a) : Circuit symbol of photodiode.

circuit symbol of a photodiode. Only minority current flows through a photodiode. Figure 16.9 (b) shows schematic of the structure of a photodiode.

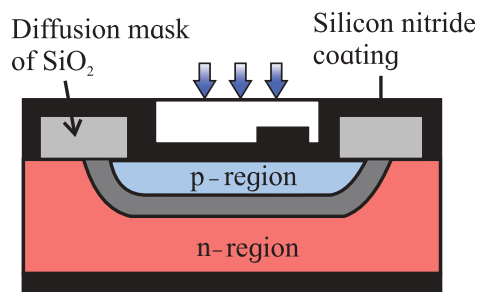

Fig. 16.9 (b) : Schematic of the structure of a photodiode.

The p-n junction of a photodiode is placed inside a glass material so that only the junction of a photodiode is exposed to light. Other part of the diode is generally painted with an opaque colour or covered. Figure 16.9 (c) shows a typical photodiode.

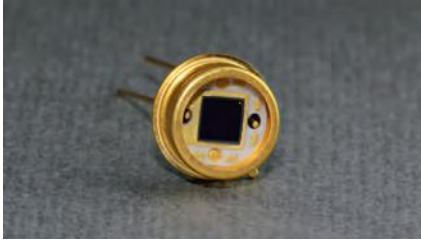

Fig. 16.9 (c) : A typical photodiode.

Working Principle of Photodiode:

When a p-n junction diode is reverse biased, a reverse saturation current flows through the junction. The magnitude of this current is constant for a certain range of reverse bias voltages. This current is due to the minority carriers on its either side. (Electrons are minority carriers in the p-region and the holes are minority carriers in the p-region of a diode). *The reverse current depends only on the concentration of the minority carriers and not on the applied voltage.* This current is called the dark current in a photodiode because it flows even when the photodiode is not illuminated. Figure 16.10 schematically shows working of a photodiode.

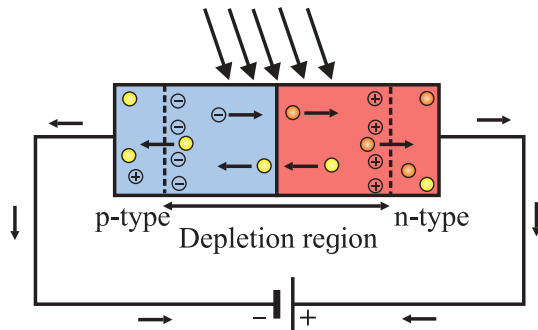

Figure 16.10: schematically shows working of a photodiode.

When a p-n junction is illuminated, electron-hole pairs are generated in the depletion region. The energy of the incident photons should be larger than the band gap of the semiconductor material used to fabricate the photodiode. The electrons and the holes are separated due to the intrinsic electric

field present in the depletion region. The electrons are attracted towards the anode and the holes are attracted towards the cathode. More carriers are available for conduction and the reverse current is increased. *The reverse current of a photodiode depends on the intensity of the incident light.* Thus, the reverse current can be controlled by controlling the concentration of the minority carriers in the junction. Figure 16.11 shows the I-V characteristic of a photodiode. It clearly shows the relation between intensity of illumination and the reverse current of a photodiode.

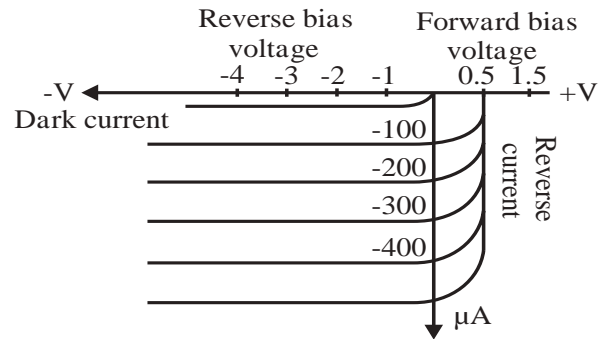

Fig. 16.11: The I-V characteristic of a photodiode.

The total current passing through a photodiode is the sum of the photocurrent and the dark current. Figure 16.12 shows the graphical relation between the reverse current of a photodiode and the intensity of illumination incident on the photodiode. The sensitivity of the device can be increased by minimizing the dark current.

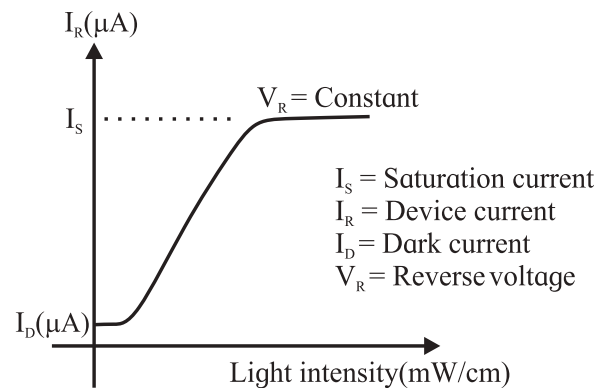

Fig. 16.12: Relation between the reverse current of a photodiode and the intensity of illumination

As you can see from the curve, reverse current increases initially with increase in the intensity of illumination. It reaches a constant value after certain voltage is reached. *This constant value is called the saturation current of the photodiode.* One more term associated with a photodiode is its dark resistance R_d . It is the resistance of a photodiode when it is not illuminated. Dark resistance of a photodiode (R_d) is defined as the ratio of the maximum reverse voltage and its dark current.

$$R_d = \frac{\text{Maximum reverse voltage}}{\text{Dark current}}$$

Advantages of photodiode

- 1) Quick response when exposed to light.
- 2) Linear response. The reverse current is linearly proportional to intensity of incident light.
- 3) High speed of operations.
- 4) Light weight and compact size.
- 5) Wide spectral response. For example, photodiodes made from Si respond to radiation of wavelengths from 190 nm (UV) to 1100 nm (IR).
- 6) Relatively low cost.

Disadvantages of photodiode

- 1) Its properties are temperature dependent, similar to many other semiconductor devices.
- 2) Low reverse current for low illumination levels.

Applications of photodiode

A photodiode has many applications in a number of fields ranging from domestic applications to industrial applications due to its linear response. The basic concept used in almost all these devices/applications is that a photodiode conducts whenever light strikes it and it stops conducting the moment light stops. Some applications of a photodiode are:

- 1) Counters and switches.
- 2) Burglar alarm systems.
- 3) Detection of visible and invisible radiations.
- 4) Circuits in which fast switching and high-speed operations are required.
- 5) Fiber optic communication systems.
- 6) Optocouplers, used to provide an electric isolation between two electronic circuits.

- 7) Photo sensors/detectors, for accurate measurement of light intensity.
- 8) Safety electronics like fire and smoke detectors



Try this

Study the relation between intensity of the incident light and the reverse current of a photodiode.

16.3.3 Solar Cell or Photovoltaic Cell:

Solar energy can be used in many ways. It is pollution free and available free of cost. Two major types of devices converting solar energy into usable form are, a) *Photo thermal devices* which convert the solar energy into heat energy. These are mostly used for providing hot water. and b) *Photo voltaic devices* which convert solar energy into electrical energy using solar cells. We will discuss the solar cells in some details. It is also known as photovoltaic cell. Light incident on a solar cell produces both a current and a voltage to generate electric power. A solar cell thus works as a source of DC power. Solar cells can supply power for electric equipment at remote place on earth or aboard a satellite or a space station.

Structure of a Solar Cell:

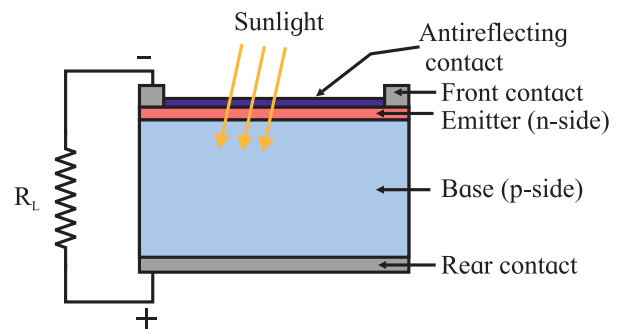

Fig.16.13: (a) Schematic structure of a solar cell.

Figure 16.13 (a) shows the schematic structure of a solar cell. It consists of a p-n junction. The n-side of the junction faces the solar radiation. The p-side is relatively thick and is at the back of the solar cell. Both the p-side and the n-side are coated with a conducting material. The n-side is coated with antireflection coating which allows visible

light to pass through it. The main function of this coating is to reflect the IR (heat) radiations and protect the solar cell from heat. This is necessary, because the electronic properties of semiconductors are sensitive to fluctuations in temperature. This coating works as the electrical contact of the solar cell. The contact on the n-side is called the front contact and that at the p-side is called the back contact or the rear contact. The n-side of a solar cell is thin so that the light incident on it reaches the depletion region where the electron-hole pairs are generated.

Material used for fabricating a solar cell should fulfil two important requirements. Firstly, it must be photosensitive material which absorbs light and raises electrons to a higher energy state. Secondly, the higher energy electrons thus generated should be taken from the solar cell into an external circuit. The electrons then dissipate their energy while passing through the external circuit and return to the solar cell. Almost all photovoltaic devices use semiconductor materials in the form of a p-n junction.

Working of a solar cell:

When light is incident on a solar cell, the following sequence of events takes place.

- 1) Electron-hole pairs are generated in the depletion region of the p-n junction. These are photo-generated carriers.
- 2) The electrons and holes are separated and collected at the cathode and the anode respectively.
- 3) The carriers are accumulated and generate a voltage across the solar cell.
- 4) Power thus produced is dissipated (utilised) in the load resistance or in the circuit connected across the solar cell.

Current produced in a in a solar cell is called the ‘light-generated current’, or ‘photo-generated current’. This is a two-step process. The first step is the absorption of incident photons to generate electron-hole pairs. Electron-hole pairs will be generated in the solar cell provided that the incident photon has energy greater than that of the band gap. Normally, the electrons and holes thus

produced recombine and will be lost. There will be no generation of current or power. However, the photo-generated electrons (in the p-type material), and the photo-generated holes (in the n-type material) are spatially separated and prevented from recombination in a solar cell.

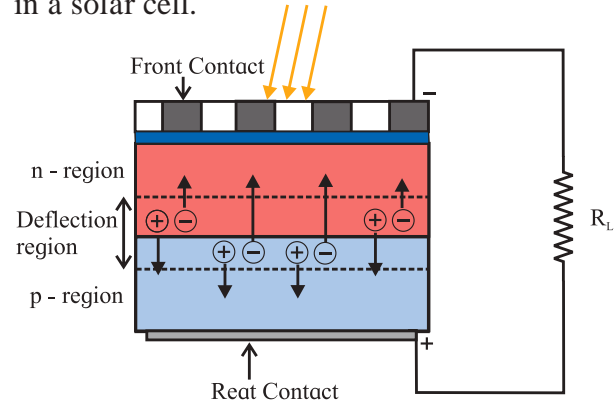

Fig. 16.13: (b) Separation of carriers in a solar cell.

This separation of carriers is possible due to the intrinsic electric field of the depletion region. Figure 16. 13 (b) shows this schematically. When the light-generated electron in the in the p-type region reaches the p-n junction, it is swept across the junction by the electric field at the junction. It reaches the n-type region where it is now a majority carrier. Similarly, the light generated hole reaches the p-type region and becomes a majority carrier in it. The positive and negative charges are thus accumulated on the p-region and the n-region of the solar cell which can be used as a voltage source. When the solar cell is connected to an external circuit, the light-generated carriers flow through the external circuit.

V-I Characteristic of solar Cell or Photovoltaic cell:

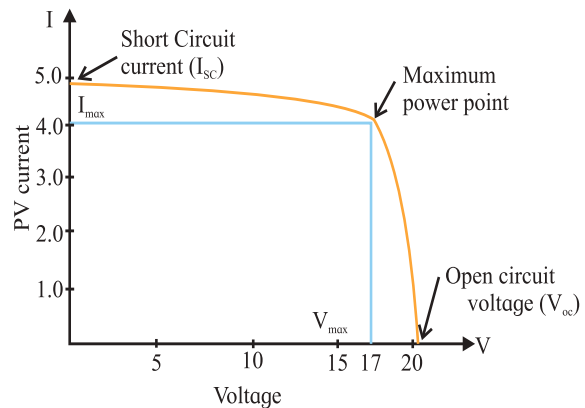

Fig. 16.14 :V-I Characteristic of solar Cell or Photovoltaic cell

Figure 16.14 shows the I-V characteristic of solar cell when illuminated. This is drawn in the fourth quadrant because a solar cell supplies current to the load. The power delivered to the load is zero when the load is short-circuited. The intersection of the curve with the I-axis is the short-circuit current, I_{sc} , corresponding to a given light intensity. The intersection of the curve with the V-axis is the open circuit voltage, V_{oc} , corresponding to given light intensity. Again, power delivered to the load is zero when the load is open. However, there is a point on the curve where power delivered $P_L = (V_{oL} \cdot I_{sc})$ is maximum.

Criteria for selection of material for solar cell:

- 1) Its band gap should be between 1.0 eV to 1.8 eV.
- 2) It should have high optical absorption (conversion of light into electrical energy).
- 3) It should have good electrical conductivity.
- 4) Material should be easily available.

Most materials used for fabrication of solar cells are have a band gap of about 1.5 eV. These include: Si ($E_g = 1.1$ eV), GaAs ($E_g = 1.43$ eV), CdTe ($E_g = 1.45$ eV), CuInSe ($E_g = 1.04$ eV). Solar cells used in domestic and space applications are mostly Si based solar cells. Solar cells are non-polluting, they require less maintenance and last longer. They have a higher cost of installation, are low in efficiency.

Use of Solar cell:

Solar cells are used for charging batteries during day time so that batteries can supply power during night. They are useful at remote places, for supplying power to various electronic equipment from calculators to satellites and space stations, to supply power to traffic signals, in communication stations, and in Lux meter to measure intensity of light.



Can you tell?

What is the difference between a photo diode and a solar cell?

When the intensity of light incident on a photo diode increases, how is the reverse current affected?

16.3.4 Light Emitting Diode / LED:

The Light Emitting Diode or LED as it is more commonly called is a *diode which emits light when large forward current passes through it.*

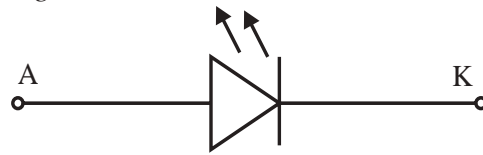

Fig. 16.15 (a): Circuit symbol of LED.

Figure 16.15 (a) shows the circuit symbol of LED and the Fig. 16.15 (b) shows a schematic construction of a typical LED. The construction of a LED is different from that of a normal diode. The n-region is heavily doped than the p-region of the p-n junction. The LED p-n junction is encased in a dome-shaped transparent case so that light is emitted uniformly in all directions and internal reflections are minimized. Metal electrodes attached on either side of the p-n junction serve as contacts for external electrical connection. The larger leg of a LED is the positive electrode or anode. LEDs with more than 2 pins are also available such as 3, 4 and 6 pin configurations to obtain multi-colours in the same LED package. Surface mounted LED displays are available that can be mounted on PCBs.

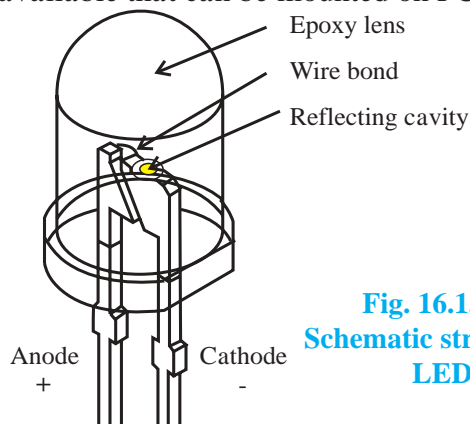

Fig. 16.15 (b): Schematic structure of LED.

LED is fabricated in such a way that light emitted is not reabsorbed into the material. It is ensured that the electron-hole recombination takes place on the surface for maximum light output.



Do you know?

LED junction does not actually emit that much light so the epoxy resin body is constructed in such a way that the photons emitted by the junction are reflected away from the surrounding substrate base to which the diode is attached and are focused upwards through the domed top of the LED, which itself acts like a lens concentrating the light. This is why the emitted light appears to be brightest at the top of the LED.

Working of a LED:

Figure 16.16 schematically shows the emission of light when electron-hole pair combines. When the diode is forward biased, electrons from the semiconductor's conduction band recombine with holes from the valence band releasing sufficient energy to produce photons which emit a monochromatic (single colour) light. Because of the thin layer, a reasonable number of these photons can leave the junction and emit coloured light. The amount of light output is directly proportional to the forward current. Thus, higher the forward current, higher is the light output.

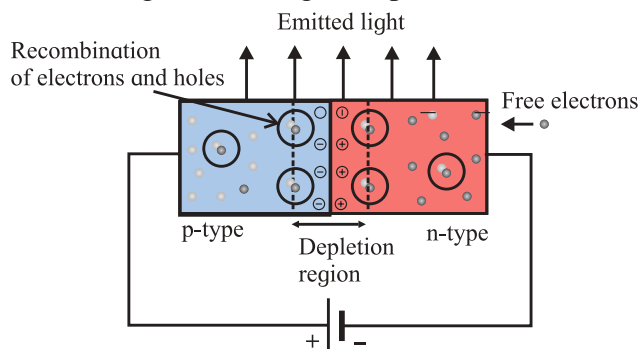

Fig. 16.16: Emission of light from LED

LEDs are fabricated by using compound semiconductors made with elements such as gallium, phosphorus and arsenic. By varying the proportions of these elements in the semiconducting materials, it is possible to

produce light of different wavelengths. For example, when LED is manufactured using aluminium gallium arsenide (AlGaAs), it emits infrared radiations. LED made using gallium arsenic phosphide (GaAsP) produces either red or yellow light, whereas LED made by using aluminium gallium phosphide (AlGaP) emits red or green light and zinc selenide (ZnSe) produce blue light.

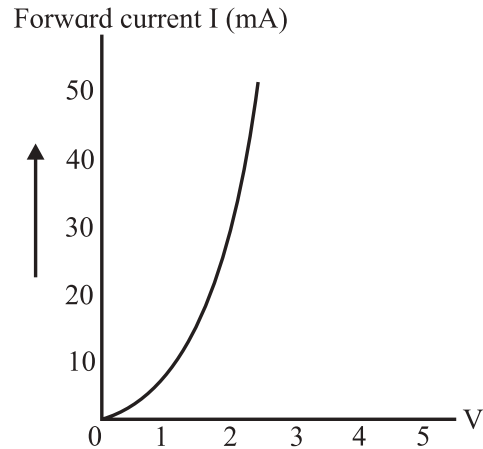

Fig.16.17: Light Emitting Diode (LED) I-V Characteristic Curves showing different colours available.

I-V Characteristics Light Emitting Diodes:

Figure 16.17 shows the I-V characteristic of LED. It is similar to the forward characteristic of an ordinary diode.



Remember this

The current rating of LED is of a few tens of milli-amps. Hence it is necessary to connect a high resistance in series with it. The forward voltage drop of an LED is much larger than an ordinary diode and is around 1.5 to 3.5 volts.

Advantages of LED:

LED is a solid state light source.

1. Energy efficient: More light output for lesser electrical power. LEDs are now capable of producing 135 lumens/watt
2. Long Lifetime: 50,000 hours or more if properly manufactured.
3. Rugged: LEDs are also called Solid State Lights (SSL) as they are made of solid material with no filament or tube or bulb to break.

- Almost no warm up period. LEDs start emitting light in nanoseconds.
- Excellent colour rendering: Colours produced by LED do not fade out making them perfect for displays and retail applications.
- Environment friendly LEDs do not contain mercury or other hazardous substances.
- Controllable: Brightness and colour of light emitted by LEDs can be controlled



Do you know?

White Light LEDs or White LED Lamps:

Shuji Nakamura, a Japanese - born American electronic engineer invented the blue LED. He was awarded the Nobel prize for physics for 2014. He was also awarded the global energy prize in the year 2015. *His invention of blue LED made the fabrication of white LED possible.*

LED lamps, bulbs, street lighting are becoming very popular these days because of the very high efficiency of LEDs in terms of light output per unit input power (in milli Watts), as compared to the incandescent bulbs. So for general purpose lightings, white light is preferred.

Commercially available white LEDs are normally manufactured by using the technique of wavelength conversion. It is a process which partly or completely converts the radiation of a LED into white light. There are many ways of wavelength conversion. One of these methods uses blue LED and yellow phosphor. In this method of wavelength conversion, a LED which emits blue colour is used to excite a yellow colour phosphor. This results in the emission of yellow and blue light and this mixture of blue and yellow light gives the appearance of white light. This method is the least expensive method for producing white light.

Disadvantages of LED:

Hazardous blue light quality, temperature dependence, voltage sensitivity, high initial cost.

Application of LED:

An LED is used in a variety of ways such as, burglar alarm system, counters, optical communication, indicator lamps in electric equipment, display screen of a cell phone handset, LED television, vehicle head lamps, domestic and decorative illumination, street lighting.



Try this

LEDs are widely used in seven segment displays. Such displays are used in calculators electronic balances, watches, digital instruments, etc. When diodes A,B,C,D,F and G are forward biased the digit 9 is displayed. Observe how digits 0 to 9 are displayed by activating varies diodes.

16.4 Bipolar Junction Transistor (BJT):

A junction transistor is a semiconductor device having two junctions and three terminals. The current in a transistor is carried by both the electrons and the holes. Hence, it is called a bipolar junction transistor. A transistor has three doped regions which form a structure with two back to back p-n junctions. There are two types of transistors, namely, (a) n-p-n transistor (b) p-n-p transistor. The circuit symbols and schematic representation of the two types of transistors are shown in Fig. 16.18 (a).

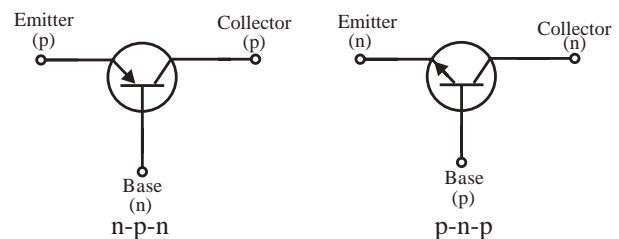

Fig. 16.18 (a): Circuit symbols of a BJT.

In the circuit symbol, the emitter and collector are differentiated by drawing an arrow. Emitter has an arrow either pointing inwards or outwards. The direction of the arrow indicates the direction of the conventional current in the transistor. For a n-p-n transistor, the arrow points away from the emitter to the

base and for a p-n-p transistor, it points away from the base, towards the emitter. This is shown in the Fig. 16.18 (b).

In an **n-p-n transistor**, a p-type semiconductor (base) layer separates two layers of the n-type semiconductor (emitter and collector). It is obtained by growing a thin layer of p-type semiconductor in between two

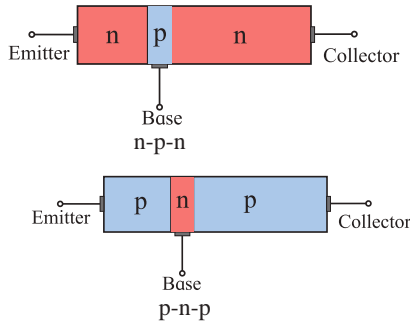

Fig. 16.18 (b): Structure of a BJT.

relatively thick layers of n type semiconductor. Similarly, for a **p-n-p transistor**, a n-type semiconductor (base) layer separates two layers of p-type semiconductor (emitter and collector). It is obtained by growing a thin layer of n-type semiconductor in between two relatively thick layers of p type semiconductor. The three layers of a transistor are the Emitter (E), the Base (b) and the Collector (C) (Fig.16.18 (b)).

A transistor can be thought to be two junction diodes connected back to back. This two-diode analogy is shown in Fig.16.19 (c).

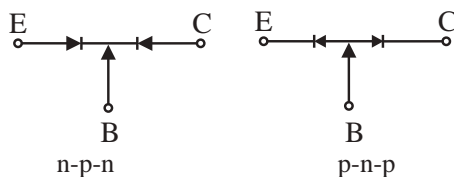

Fig. 16.18: (c) Two-diode Analogy of a BJT .

Emitter: It is a thick heavily doped layer. This supplies a large number of majority carriers for the current flow through the transistor

Base: It is the thin, lightly doped central layer.

Collector: It is on the other side of the base. It is also thick and moderately doped layer. Its area is larger than that of the emitter and the base. This layer collects a major portion of the majority carriers supplied by the emitter. The collector also helps dissipation of any small amount of heat generated.

Depletion region: The depletion regions are formed at the emitter-base junction and the base-collector junction.

Current: The emitter current I_E , the base current I_B and the collector current I_C is as indicated in the Fig. 16.19 (d).

Resistance: The emitter-base junction has low resistance while the base-collector junction has a high resistance.

There are two p-n junctions in a transistor, the emitter-base (E-B) junction and the collector-base (E-B) junction, and they can be biased in different ways. *In the most common method of biasing a transistor, the emitter base junction is forward biased and the collector base junction is reverse biased.* This helps an easy flow of the majority carriers supplied by the emitter through the transistor.



Use your brain power

What would happen if both junctions of a BJT are forward biased or reverse biased?

Working of a p-n-p transistor:

Electrons are the majority carriers in the emitter of a n-p-n transistor. The emitter current I_E is due to electrons. The current flowing through the E-B junction is large because it is forward biased. The B-C junction is also large though the junction is reverse biased. It is interesting to know how this is possible.

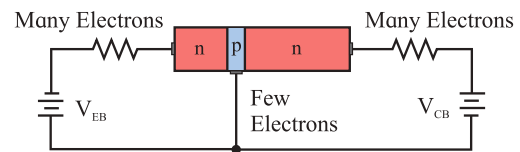

Fig. 16.19 (a): Biasing of n-p-n transistor.

Figure 16.19 (a) shows typical biasing circuit of a n-p-n transistor. At the instant the forward bias is applied to the E-B junction, electrons in the emitter region (n-type) have not entered the base region (p-type) as shown in Fig. 16.19 (b).

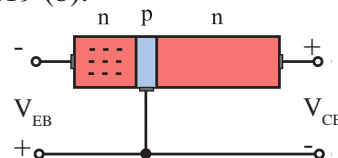

Fig. 16.19 (b): Majority carriers in emitter.

When the biasing voltage V_{BE} is greater than the barrier potential (0.6-0.7V for silicon transistors, which are commonly used), many electrons enter the base region and form the emitter current I_E as shown in the Fig. 16.19 (c).

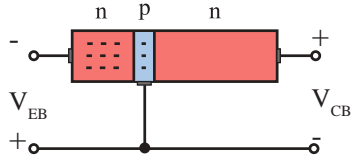

Fig. 16.19 (c): Injection of majority carriers into base.

These electrons can now flow in two directions. They can either flow through the base circuit and constitute the base current (I_B), or they can also flow through the collector circuit and contribute towards the collector current (I_C). The base current is small (about 5% of I_E) because the base is thin and also, it is lightly doped.

The base of a transistor plays a crucial role in its action. Electrons injected from the emitter into the base diffuse into the collector-base depletion region due to the thin base region. When the electrons enter the collector-base depletion region, they are pushed into the collector region by the electric field at the collector-base depletion region. The collector current (I_C) flow through the external circuit as shown in Fig. 19.16 (d). The collector current I_C is about 95% of I_E .

Majority of the electrons injected by the

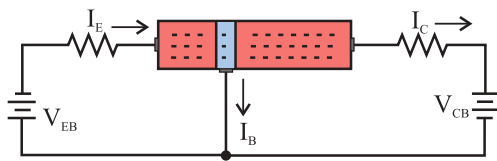

Fig. 16.19 (d): Electron flow through a transistor.

emitter into the base are thus collected by the collector and flow through the collector circuit.

A p-n-p transistor works exactly the same way except that the majority carriers are now holes.

From the schematic working shown in Fig. 16.19, we can write $I_E = I_B + I_C$. Since the base current I_B is very small we can write $I_C \approx I_E$.



Remember this

The lightly doped, thin base region sandwiched between the heavily doped emitter region and the intermediate doped collector region plays a crucial role in the transistor action.

Transistor configuration:

The possible configurations of transistor in a circuit are, (a) Common Emitter, CE (b) Common Base, CB and (c) Common Collector, CC.

Common Emitter configuration

The emitter of the transistor is common to both the input and the output, Fig. 16.20 (a).

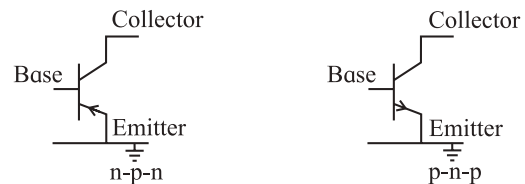

Fig. 16.20 (a): Common emitter configuration.

Common Base configuration

The base of the transistor is common to both the input and the output, Fig. 16.20 (b).

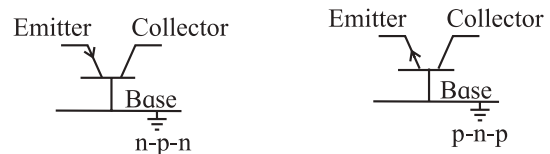

Fig. 16.20 (b): Common base configuration.

Common Collector configuration

The collector of the transistor is common to both the input and the output, Fig. 16.20 (c).

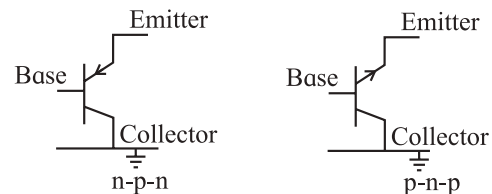

Fig. 16.20 (c): Common collector configuration.

16.4.1 The Common Emitter (CE) Configuration

We will discuss the common emitter configuration in some details because it is the most commonly used configuration.

In the Common Emitter or grounded emitter configuration, the input signal is applied between the base and the emitter, while the output is obtained between the collector and the emitter as shown in the Fig. 16.21.

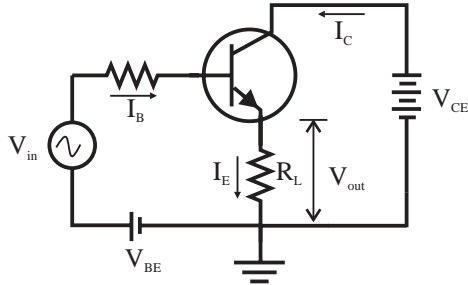

Fig.16.21: The Common Emitter configuration.

The common emitter amplifier configuration, to be discussed in section 16.4.3, produces the highest current and power gain of all the three bipolar transistor configurations. This is mainly because the input impedance is low as it is connected to a forward biased p-n junction, while the output impedance is high as it is taken from a reverse biased p-n junction.

In this type of configuration, the current flowing out of the transistor must be equal to the currents flowing into the transistor as the emitter current is given by,

$$I_E = I_C + I_B \quad \text{--- (16.1)}$$

As the load resistance (R_L) is connected in series with the collector, the current gain of the common emitter transistor configuration is quite large. The current gain is called the current amplification factor and is defined as the ratio

$$\beta_{DC} = I_C / I_B \quad \text{--- (16.2)}$$

Similarly, the ratio of the collector current and the emitter current is defined as

$$\alpha_{DC} = I_C / I_E \quad \text{--- (16.3)}$$

The ratios α_{DC} and β_{DC} are related.

From Eq. (16.1) and Eq. (16.2) we have,

$$I_C = \alpha I_E = \beta I_B \quad \text{--- (16.4)}$$

$$\therefore \alpha_{DC} = \frac{\beta}{\beta + 1} \quad \text{--- (16.5)}$$

$$\text{and } \beta_{DC} = \frac{\alpha}{\alpha - 1} \quad \text{--- (16.6)}$$

Since the electrical relationship between these three currents I_B , I_C and I_E is determined by the physical construction of the transistor itself, any small change in the base current (I_B), will result in a much larger change in the collector current (I_C). Thus, a small change in current flowing in the base will control the current in the emitter-collector circuit. Typical value of β_{DC} is between 20 and 200 for most general purpose transistors. So if a transistor has a $\beta_{DC} = 100$, then one electron will flow from the base terminal for every 100 electrons flowing between the emitter-collector terminal.

16.4.2 The Common Emitter (CE) characteristic:

A typical circuit used to study the common emitter (CE) characteristic is shown in the Fig. 16.22.

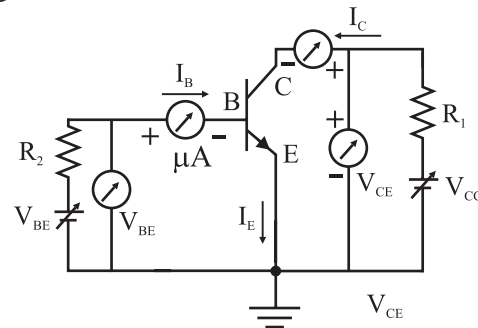

Fig. 16.22: Circuit to study Common Emitter (CE) characteristic.

The Input characteristics:

The variation of base current I_B with base-emitter voltage, V_{BE} , is called *input characteristic*. While studying the dependence of I_B on V_{BE} , the collector-emitter voltage V_{CE} is kept fixed. The characteristic is shown in the Fig. 16.23.

As we can see from the figure, initially, the current is very small till the barrier potential is overcome. When the voltage V_{BE} is more than the barrier potential, the characteristic is similar to that of a forward biased diode.

The input dynamic resistance r_i of a transistor is defined as the ratio of the change in the base-emitter voltage and the resulting change in the base current at a constant collector-base voltage.

$$r_i = \frac{\Delta V_{BE}}{\Delta I_B} \quad \text{--- (16.7)}$$

for V_{CE} constant.

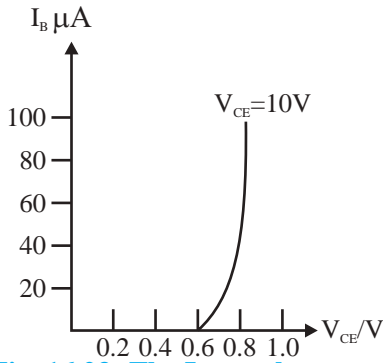

Fig. 16.23: The Input characteristics

The output characteristic of a transistor is shown in the Fig. 16.24

The variation of the collector current I_C with variation in the collector-emitter voltage is called the *output characteristic* of a transistor. The base current I_B is constant at this time. From the curve we can see that the collector current I_C is independent of V_{CE} as long as the collector-emitter junction is reverse biased. Also, the collector current I_C is large for large values of the base current I_B when V_{CE} is constant.

The output dynamic resistance r_o of a transistor is defined as the ratio of the change in the collector-emitter voltage V_{CE} and the change in the collector current I_C for constant base current I_B .

$$r_o = \frac{\Delta V_{CE}}{\Delta I_C} \quad \text{--- (16.8)}$$

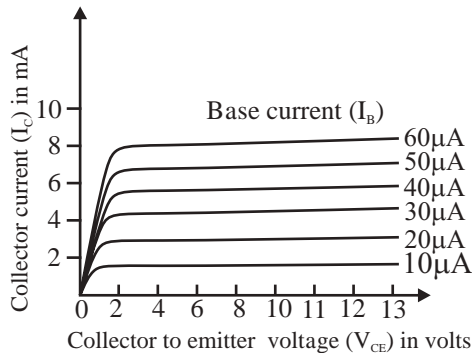

Fig. 16.24: The Input characteristics

16.4.3 Transistor as an Amplifier:

Amplifier is a device which is used for increasing the amplitude of the alternating signal (voltage, current or power). We will

discuss an amplifier using an n-p-n transistor in common emitter configuration. Figure 16.25 shows a typical circuit used for transistor amplifier.

A small sinusoidal input signal is superimposed on the DC bias as shown in the Fig. 16.25. The base current I_B and the collector current I_C will have these sinusoidal variations superimposed on them. This causes the output voltage V_o also to change sinusoidally. A capacitor is connected in the output circuit to block the DC component. A load resistance R_L is connected in the collector circuit. Output is obtained across this resistance.

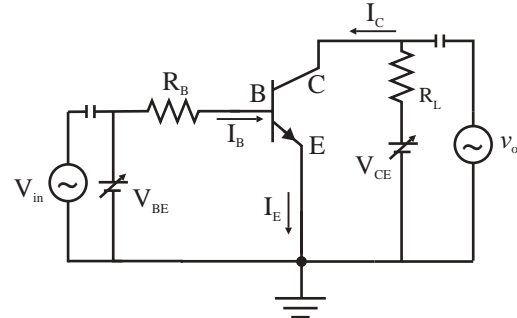

Fig. 16.25: Typical transistor amplifier circuit.

Working of the amplifier:

Let us discuss the working of the amplifier when the input signal v_i is not applied. Consider the output loop. We have, from the Kirchhoff's law,

$$V_{CC} = V_{CE} + I_C R_L \quad \text{--- (16.9)}$$

Similarly, for the input loop we have,

$$V_{BB} = V_{BE} + I_B R_B \quad \text{--- (16.10)}$$

When some AC signal is applied, v_i is not zero and we can write,

$$V_{BE} + v_i = v_{BE} + I_B R_B + \Delta I_B (R_B + r_i) \quad \text{--- (16.11)}$$

The change in V_{BE} can be related to the input resistance and the change in the base current I_B . Hence, using Eq. (16.7) we can write,

$$v_i = \Delta I_B (R_B + r_i) = \Delta I_B r_i \quad \text{because } R_B \text{ is small.}$$

Changes in the base current cause changes in the collector current. We will now define the AC current gain β_{AC} .

$$\beta_{AC} = \frac{i_C}{i_B}$$

The AC current gain β_{AC} is almost the same as the DC current gain β_{DC} for normal operating voltages.

The changes in the base current I_B cause changes in the collector current I_C . This changes the voltage drop across the load resistance because V_{CC} is constant. We can write,

$$\Delta V_{CC} = \Delta V_{CE} + R_L I_C = 0, \text{ therefore,}$$

$$\Delta V_{CE} = -R_L I_C$$

The change in the output voltage ΔV_{CE} is the output voltage V_o hence we can write,

$$V_o = \Delta V_{CE} = \beta_{AC} R_L \Delta I_B$$

We now define the voltage gain A_v of the amplifier as,

$$A_v = \frac{V_o}{V_i} = \frac{\Delta V_{CE}}{r_i \Delta I_B}$$

The voltage gain is hence given by,

$$A_v = -\frac{\beta_{AC} R_L}{r_i}$$

The negative sign indicates that the output voltage and the input voltage are out of phase. We know that there is also a current gain β_{AC} in the common emitter configuration. We can therefore write the power gain A_p as,

$$A_p = \beta_{AC} A_v$$

We have ignored the negative sign for the voltage gain to write the magnitude. A transistor can be used to gain power because $\beta_{AC} > 1$.



Use your brain power

If a transistor amplifies power, explain why it is not used to generate power.

16.5 Logic Gates

In XIth Std. we studied continuously varying signal (voltage or current). These are called analog signals. For example, a sinusoidal voltage is an analog signal Fig. 16.26 (a). In an analog electronic circuit, the output signal varies continuously according to the input signal.

A signal (voltage or current) which can have only two discrete values is called a digital signal. For example, a square wave is a digital signal Fig. 16.26 (b). In digital circuit, the output voltage can have only two

states (i.e. values), either low (0 V) or high (+5 V) value. An electronic circuit that handles only a digital signal is called a digital circuit, and the branch of electronics which deals with digital circuits is called digital electronics.

Logic gate:

A digital circuit with one or more input signals but only one output signal is called a logic gate. It is a switching circuit that follows certain logical relationship between the input and output voltages. Therefore, they are generally known as logic gates; gates because they control the flow of signal or information. The output of a logic gate can have only one of the two possible states, i.e., either a high voltage or low voltage.

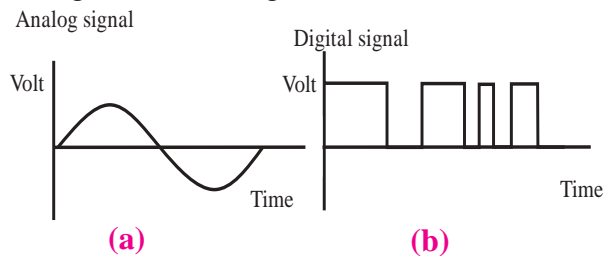

16.26: (a) Analogue signal (b) Digital signal

Whether the output voltage of a logic gate is high (1) or low (0) will depend upon the condition at its input. There are five common logic gates, viz., the NOT gate, the AND gate, the OR gate, the NAND gate, and the NOR gate. Each logic gate is indicated by a symbol and its function is defined by a truth table. A truth table shows all possible combinations of the input and corresponding outputs. The truth table defines the function of a logic gate. Truth tables help understand the behaviour of a logic gate. All logic gates can be analysed by constructing a truth table. The mathematical statement that provides the relationship between the input and the output of a logic gate is called a Boolean expression. We will study these basic logic gates at an elementary level.

16.5.1 NOT Gate :

This is the most basic logic gate. It has one input and one output. It produces a 'high' output or output '1' if the input is '0'. When the input is 'high' or '1', its output is 'low' or '0'. That is, it produces a negated version of the input at its output. This is why it is also

known as an inverter. The symbol and the truth table for a NOT gate is shown in Fig. 16.27. The Boolean equation of a NOT gate is:

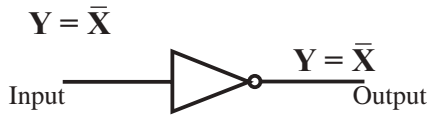

Input	Output
X	Y
0	1
1	0

Fig. 16.27 : NOT gate symbol and its Truth table.

16.5.2 OR Gate:

An OR gate has two or more inputs and one output. It is also called logical addition. The output Y is 1 or high when either input A or input B or both are 1, that is, if any one of the input is high or both inputs are high, the output is '1' or high. The symbol and the truth table for an OR gate are shown in Fig. 16.28.

The Boolean expression for an OR gate is :

$Y = A + B$



Input A	Input B	Output Y
0	0	0
1	0	1
0	1	1
1	1	1

Fig. 16.28 : OR gate symbol and its Truth table.

16.5.3 AND Gate:



Input A	Input B	Output Y
0	0	0
0	1	0
1	0	0
1	1	1

Fig 16.29 : AND gate symbol and its Truth table

An AND gate has two or more inputs and one output. The AND operation represents a logical multiplication. The output Y of AND gate is high or 1 only when input A and input B are both 1 or both are high simultaneously. The logic symbol and truth table for this gate are given in Fig. 16.29. The Boolean expression for an AND gate is :

$Y = A \cdot B$

16.5.4 NAND Gate:

The NAND gate is formed by connecting the output of a NOT gate to the input of an AND gate. The output of a NAND gate is exactly opposite to that of an AND gate. If the inputs A and B are both high or '1', the output Y is negation, i.e., the output is low or '0'. The gate derives its name from this NOT-AND behaviour. Figure 16.30 shows the symbol and the truth table of a NAND gate. The Boolean expression for a NAND gate is:

$Y = \overline{A \cdot B}$

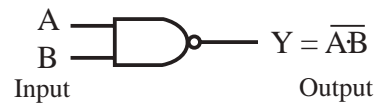

Input A	Input B	Output Y
0	0	1
0	1	1
1	0	1
1	1	0

Fig .16.30 : NAND gate symbol and its Truth table.

16.5.5 NOR Gate:

The NOR gate is formed by connecting the output of a NOT gate to the input of an OR gate. The output of a NOR gate is exactly opposite to that of an OR gate. The output Y of a NOR gate is high or 1 only when both the inputs are low or 0. The symbol and truth table for NOR gate is given in Fig. 16.31. The Boolean expression for a NOR gate is:

$Y = \overline{A + B}$

NAND gate and NOR gate are called Universal Gates because any gate can be implemented by the combination of NAND gates or NOR gates.



Input A	Input B	Output Y
0	0	1
0	1	0
1	0	0
1	1	0

Fig. 16.31: NOR gate symbol and its Truth table.

16.5.6 Exclusive OR/ X-OR Gate :

The Exclusive-OR logic function is a very useful circuit that can be used in many different types of computational circuits. The ability of the Exclusive-OR gate to compare two logic levels and produce an output value dependent upon the input condition is very useful in computational logic circuits. The output of an Exclusive-OR gate goes 'HIGH' only when its two input terminals are at different logic levels with respect to each other. An odd number of high or '1' at its input gives high or '1' at the output. These two inputs can be at high level ('1') or at low level ('0') giving us the Boolean expression:

$$C = (A \oplus B) = \bar{A} \cdot B + A \cdot \bar{B}$$

Figure 16.32 shows the symbol and truth table of two input x-OR gate.

Symbol	Truth Table		
	A	B	C
	0	0	0
	1	0	1
	0	1	1
	1	1	0
Boolean Expression $C = A \oplus B$	The output is 'high' when either of the inputs A or B is high, but not if both A and B are high.		

Fig. 16.32: Two input X-OR gate symbol and its Truth table.



Internet my friend

- <https://www.electrical4u.com/solar-cell/>
- <https://www.electrical4u.com/photodiode/>
- <https://www.electrical4u.com/solar-cell/>
- <https://www.electrical4u.com/working-principle-of-light-emitting-diode/>



Exercises

1 Choose the correct option.

- In a BJT, largest current flow occurs
 - in the emitter
 - in the collector
 - in the base
 - through CB junction
- A series resistance is connected in the Zener diode circuit to
 - Properly reverse bias the Zener
 - Protect the Zener
 - roperly forward bias the Zener
 - Protect the load resistance
- A LED emits visible light when its
 - junction is reverse biased
 - depletion region widens
 - holes and electrons recombine
 - junction becomes hot
- Solar cell operates on the principle of:
 - diffusion
 - recombination
 - photo voltaic action
 - carrier flow
- A logic gate is an electronic circuit which:
 - makes logical decisions
 - allows electron flow only in one direction
 - works using binary algebra
 - alternates between 0 and 1 value

2 Answer in brief.

- Why is the base of a transistor made thin and is lightly doped?

- ii) How is a Zener diode different than an ordinary diode?
- iii) On which factors does the wavelength of light emitted by a LED depend?
- iv) Why should a photodiode be operated in reverse biased mode?
- v) State the principle and uses of a solar Cell.
3. Draw the circuit diagram of a half wave rectifier. Explain its working. What is the frequency of ripple in its output?
4. Why do we need filters in a power supply?
5. Draw a neat diagram of a full wave rectifier and explain it's working.
6. Explain how a Zener diode maintains constant voltage across a load.
7. Explain the forward and the reverse characteristic of a Zener diode.
8. Explain the working of a LED.
9. Explain the construction and working of solar cell.
10. Explain the principle of operation of a photodiode.
11. What do you mean by a logic gate, a truth table and a Boolean expression?
12. What is logic gate? Write down the truth table and Boolean expression for 'AND' gate.
13. What are the uses of logic gates? Why is a NOT gate known as an inverter?
14. Write the Boolean expression for (i) OR gate, (ii) AND gate, and (iii) NAND Gate.
15. Why is the emitter, the base and the collector of a BJT doped differently?
16. Which method of biasing is used for operating transistor as an amplifier?
17. Define α and β . Derive the relation between them.
18. The common-base DC current gain of a transistor is 0.967. If the emitter current is 10mA. What is the value of base current.
[Ans: 0.33mA]
19. In a common-base connection, a certain transistor has an emitter current of 10mA and collector current of 9.8 mA. Calculate the value of the base current.
[Ans: 0.2mA]
20. In a common-base connection, the emitter current is 6.28mA and collector current is 6.20 mA. Determine the common base DC current gain.
[Ans: 0.987]

$$\lambda = \frac{h}{p}$$

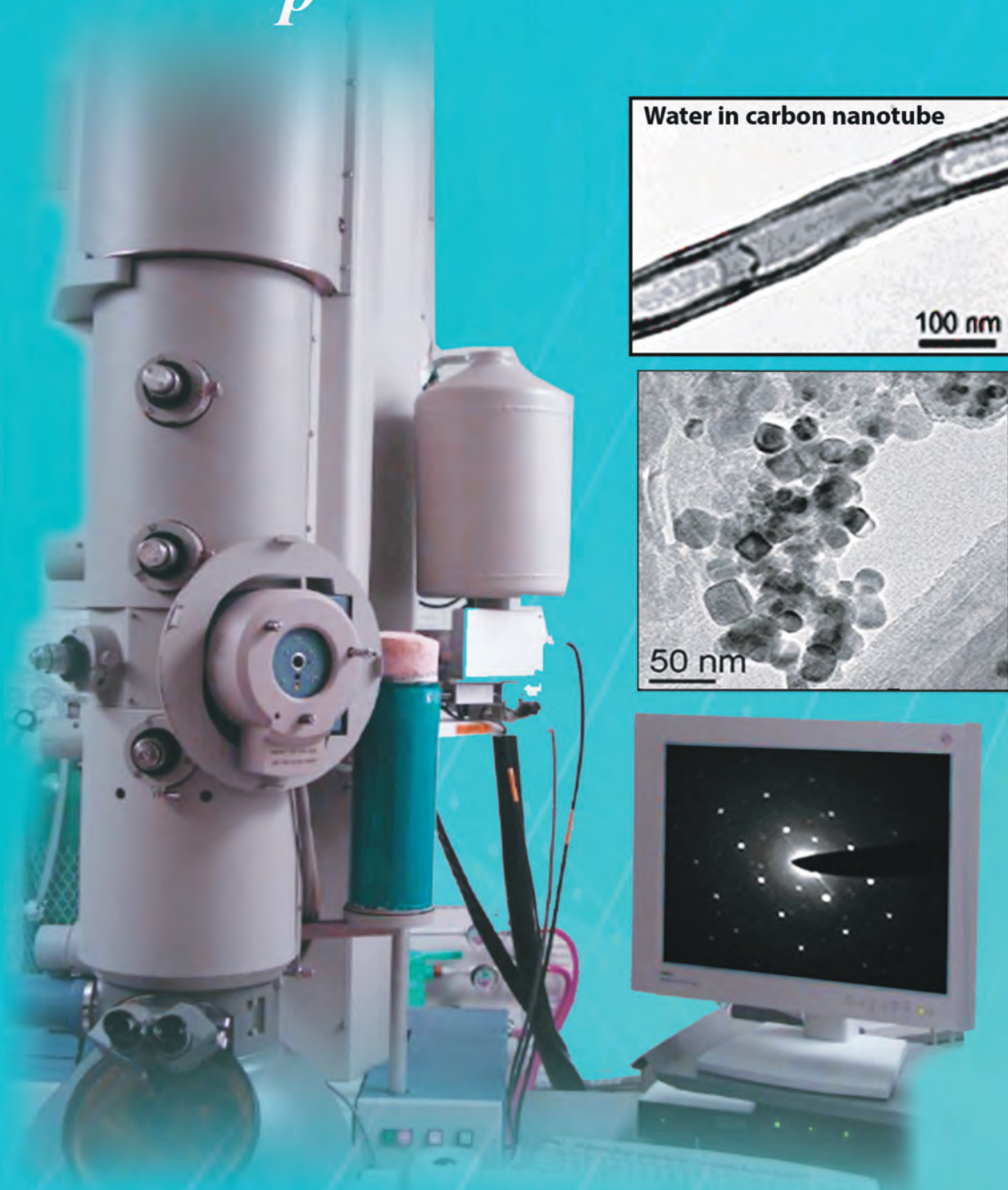

Maharashtra State Bureau of Textbook Production and Curriculum Research, Pune

भौतिकशास्त्र - इयत्ता १२ वी (इंग्रजी माध्यम)

₹ 193.00